

Kit 3021

FIAT Doblo, 3-dr Van, 00-03, 04-05, 06-09

FIAT Doblo, 4-dr Van, 00-03, 04-05, 06-09

FIAT Doblo, 5-dr Van, 00-03, 04-05, 06-09

FIAT Doblo Maxi, 4-dr Van, 08-09

FORD Tourneo Connect, 5-dr Bus, 03-

FORD Transit Connect, 4-dr Van, 03-

NISSAN Kubistar, 5-dr Van, 04-

RENAULT Kangoo, 5-dr Van, 98-02, 03-07, 08-

RENAULT Kangoo Maxi, 5-dr Van, 10-

This Kit is only for vehicles with fixpoint mounting.

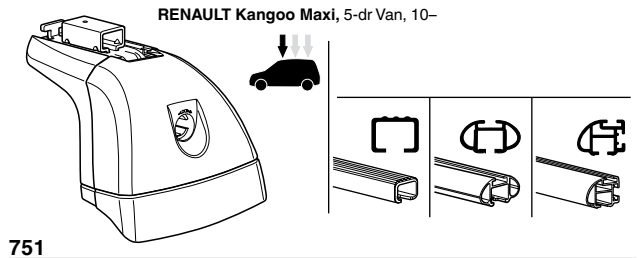
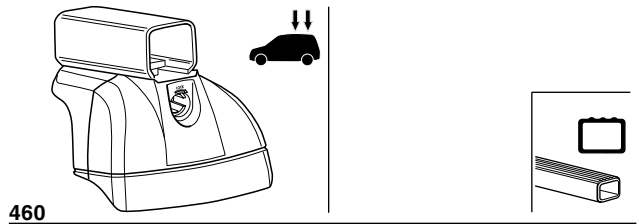
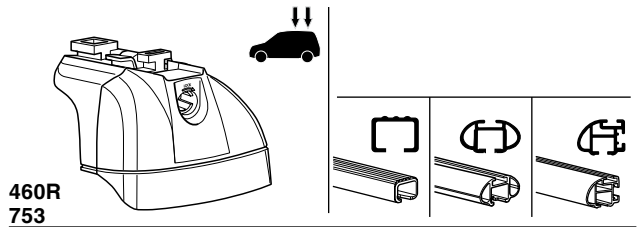

6 kg / 13 lbs + xx kg / xx lbs = **Max. 75kg**
Max. 165 lbs

9 kg / 20 lbs + xx kg / xx lbs = **Max. 100kg**
Max. 220 lbs

Warning: Do not exceed weight limits. Arrows indicate weight distribution on the roof rack.

THULE Kit XXXX instructions

Warning: Wind speed limits for safe travel with a roof rack.

80 km/h	130 km/h
50 Mph	80 Mph
40 km/h	25 Mph

km/h Mph

A Preparing the roof surface.
B Cleaning the surface.
C Mounting the bars.

Kit

- 01 x 4
- 26 x 2
- 27 x 2
- 31464 M6x30 mm x 4
- 50603 M8x40 mm x 4
- RR, FR, FL, RL x 1
- 50786 x 4
- 50229 x 1 (6 mm)

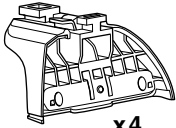
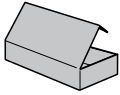

753

x4



x4



x4



16 mm
x8

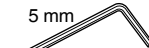

x1



x4



x1

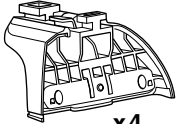

460R

x4



x4



x4



16 mm
x8



x1



x4

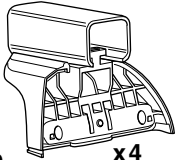

460

x4



x4



x4



16 mm
x8



x1



x4

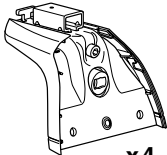

751

x4



x4



x4



12 mm
x8



x1



x4



x1

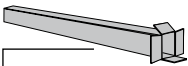

x2



x1

17 mm



x2

23 mm



x2

23 mm



x2



x2

17 mm

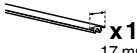

x2

23 mm

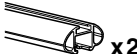

x2



x2

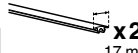

x2

25 mm



x2



x4

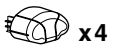

x4



x4



x2

x2

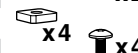

x4

x4



x1

5 mm

1

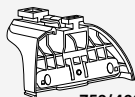

753/460R



460

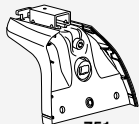

751

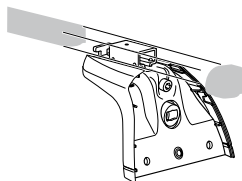
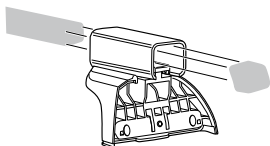
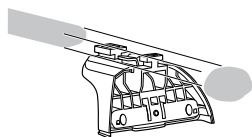

x4

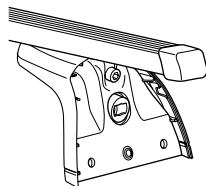
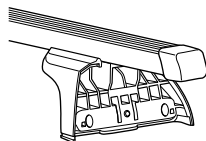
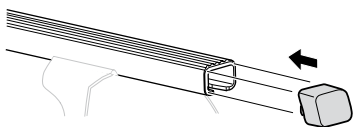

x4

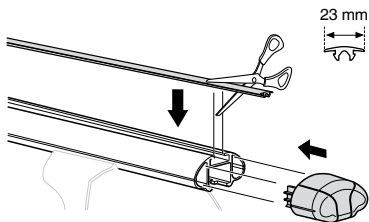

23 mm

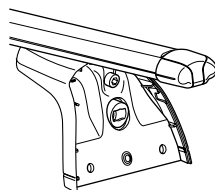
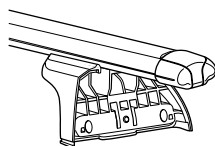
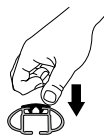



 x4

 x4

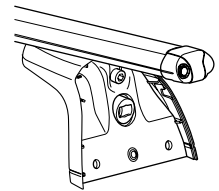
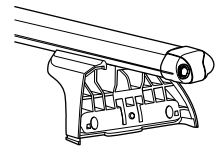
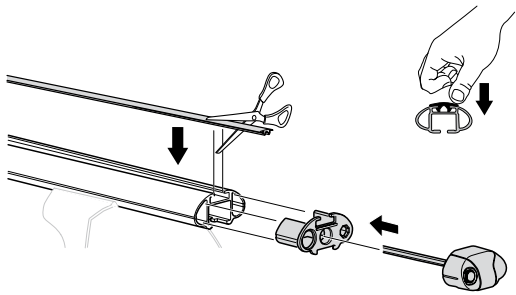

 x4

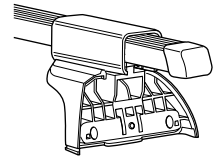
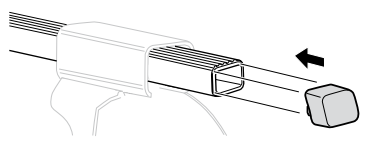

 x2

 x2

 x4

 x4

 x1
5 mm

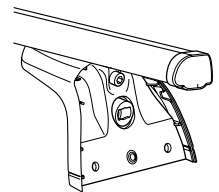
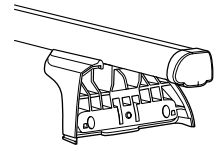
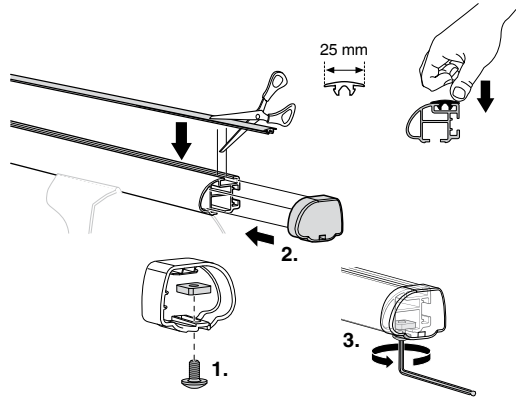

2

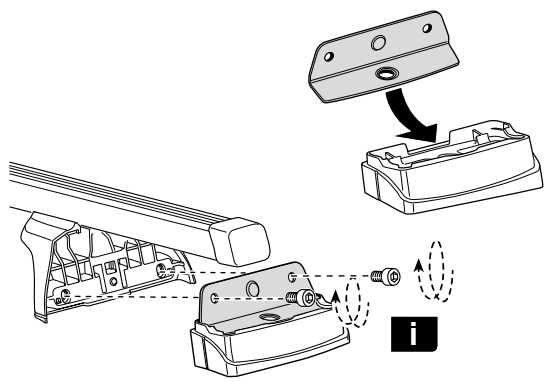
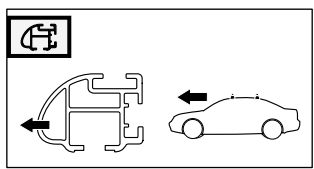
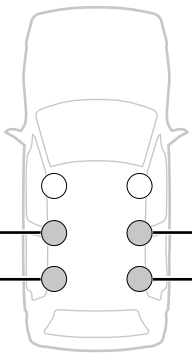
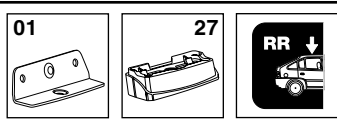
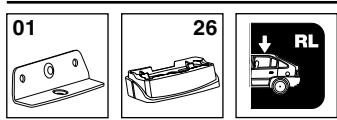
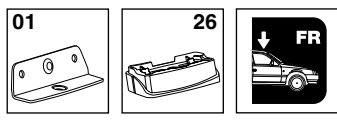
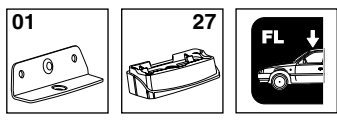
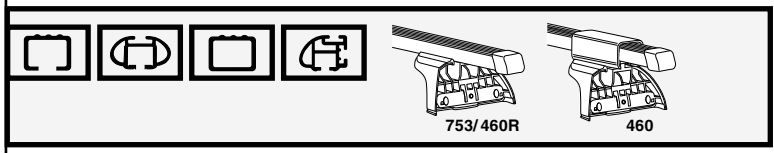
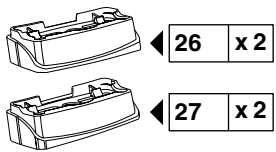
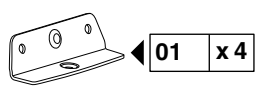

i

- GB** Only a few turns
- D** Nur wenige Umdrehungen
- F** Quelques tours uniquement
- NL** Slechts enkele slagen
- I** Solo qualche giro
- E** Sólo algunas vueltas
- PT** Noções básicas
- S** Endast några varv
- FIN** Vain muutama kierros
- EST** Ainult mõni pööre
- LAT** Tikai dažī apgriezieni
- LIT** Tik keli pasukimai
- PL** Wystarczy kilka obrotów
- RU** Достаточно нескольких оборотов
- CZ** Pouze několik otáček
- SK** Len niekoľko otáčok
- SLO** Le nekaj obratov

- HR** Samo nekoliko okreta
- HU** Csak néhány fordítás
- GR** Μόνο μερικές στροφές
- TR** Yalnız birkaç kez çevirm
- 中文** 只有几个转向
- 한국어** 두 세번만
- 日本語** 数回転のみ
- ไทย** หมุนเพียงไม่กี่รอบ

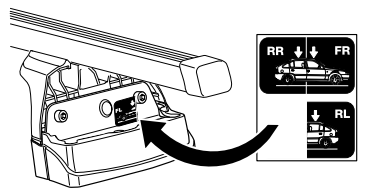

2

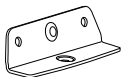

01 x 2

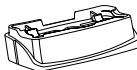

26 x 1



27 x 1



x 4



x 1

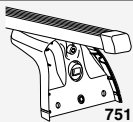

751

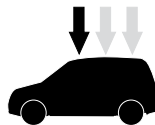

RENAULT Kangoo Maxi, 5-dr Van, 10-

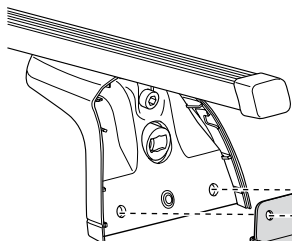
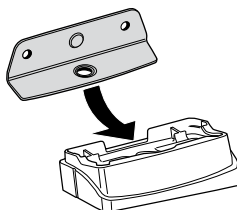
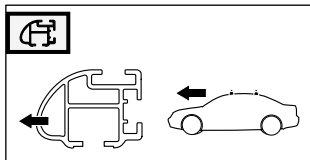
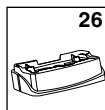
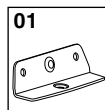
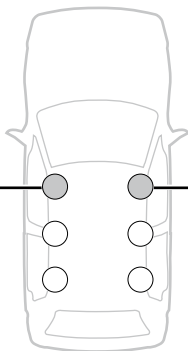
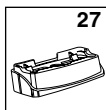
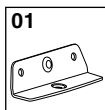

6 Nm

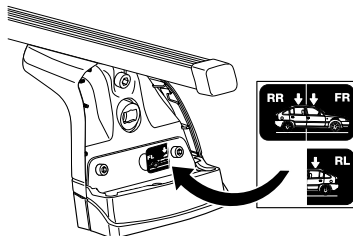

3

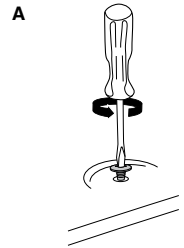
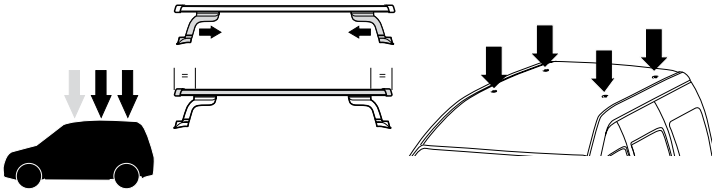

B FIAT Doblo, 3-dr Van, 00-03, 04-05, 06-09
 FIAT Doblo, 4-dr Van, 00-03, 04-05, 06-09
 FIAT Doblo, 5-dr Van, 00-03, 04-05, 06-09
 FIAT Doblo Maxi, 4-dr Van, 08-09

FORD Tourneo Connect, 5-dr Bus, 03-
 FORD Transit Connect, 4-dr Van, 03-
 NISSAN Kubistar, 5-dr Van, 04-
 RENAULT Kangoo, 5-dr Van, 98-02, 03-07, 08-
 RENAULT Kangoo Maxi, 5-dr Van, 10-

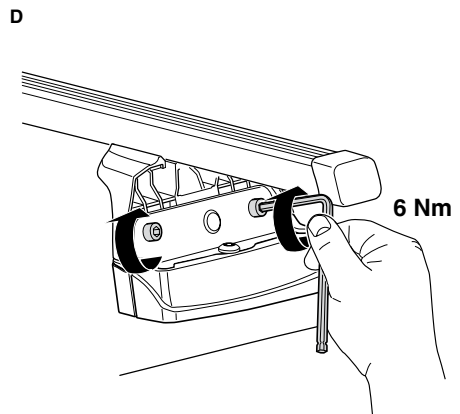
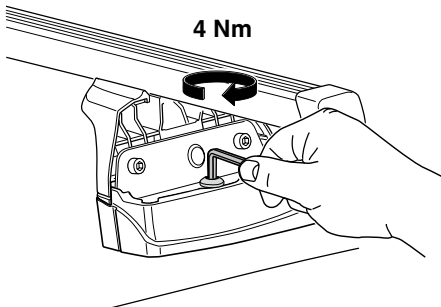
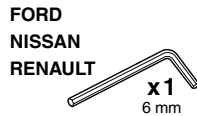
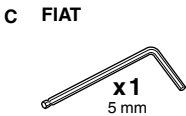
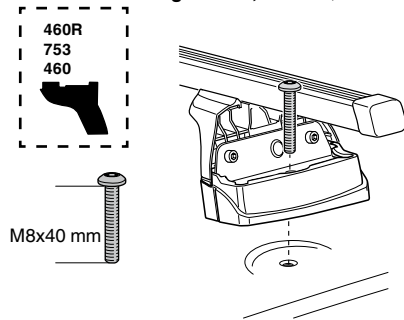
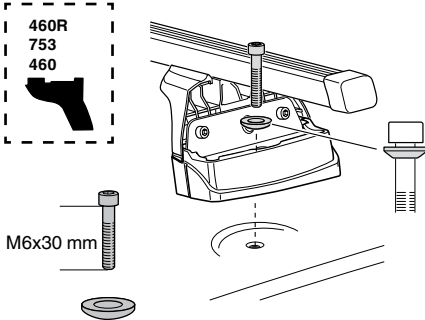

3

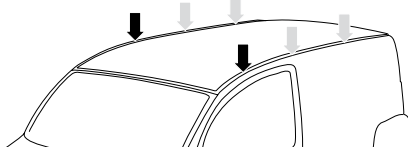
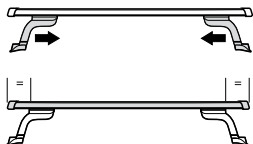
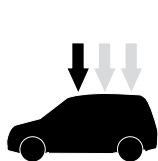
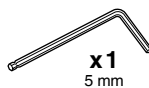
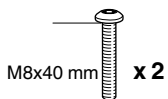

A RENAULT Kangoo Maxi, 5-dr Van, 10-

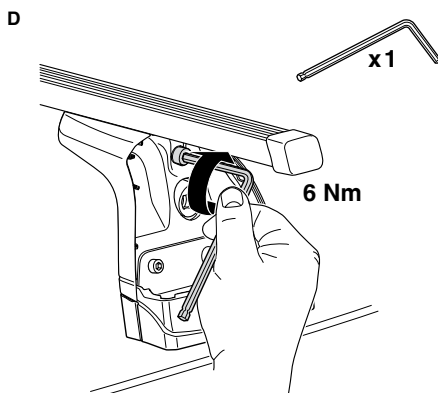
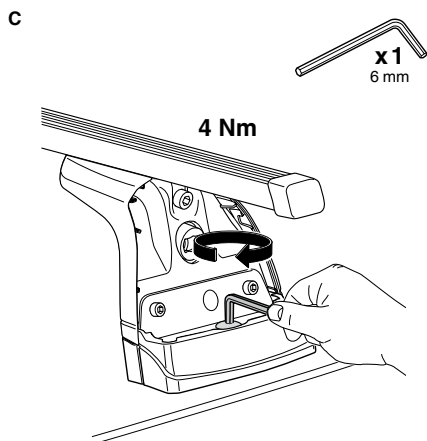
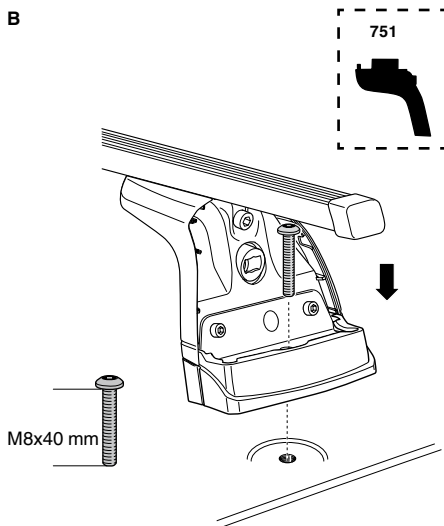
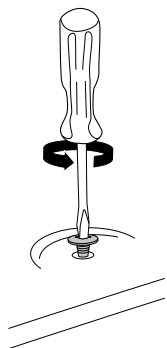

4



753 x4



x4



x1

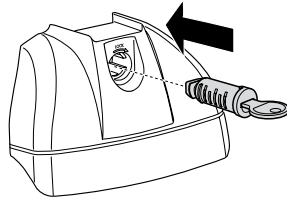

460/460R x4



x4

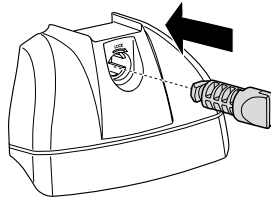

751 x4



x4



x1

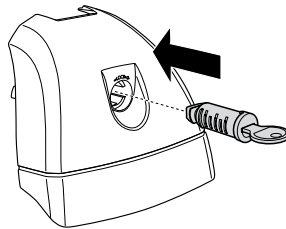

5



753 **x4**

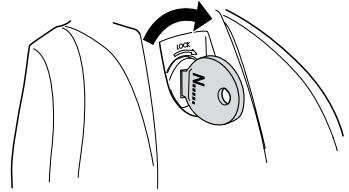
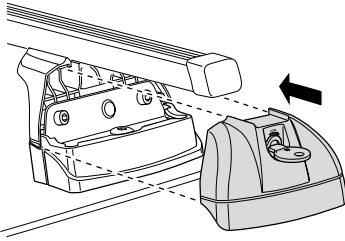

460/460R **x4**

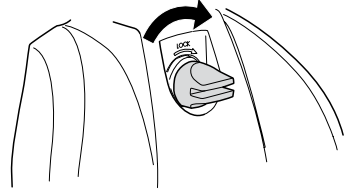
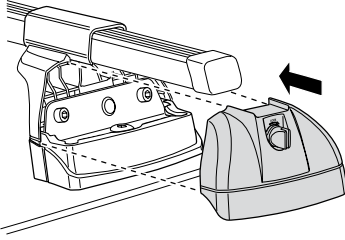

5 mm



x1

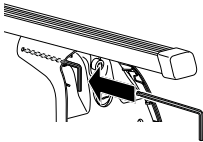

751 **x4**

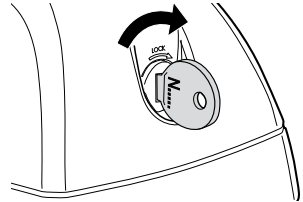
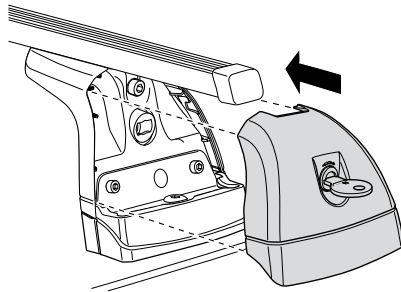

6

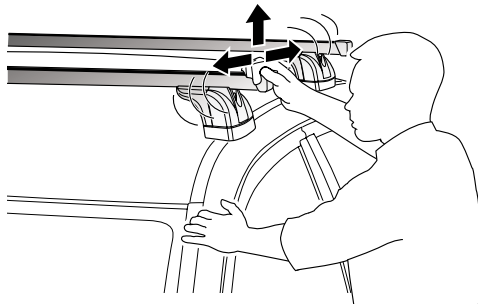

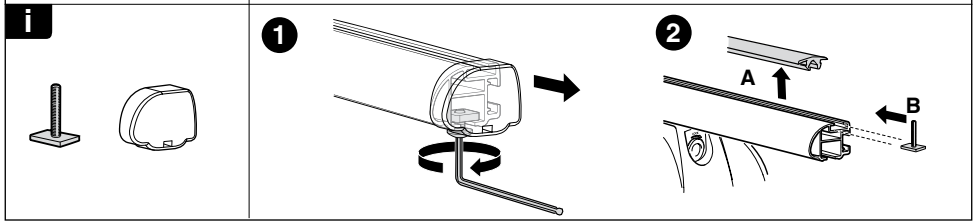
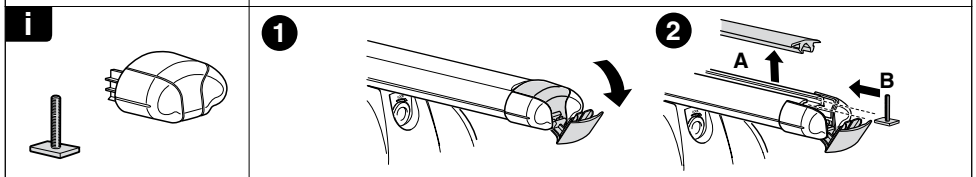
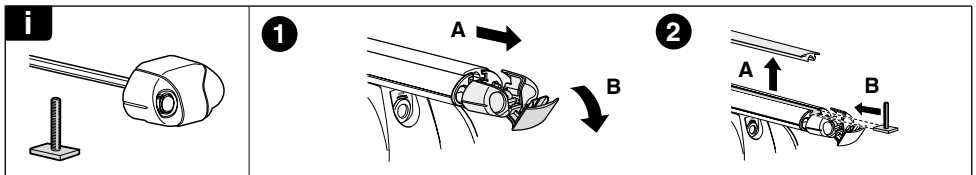
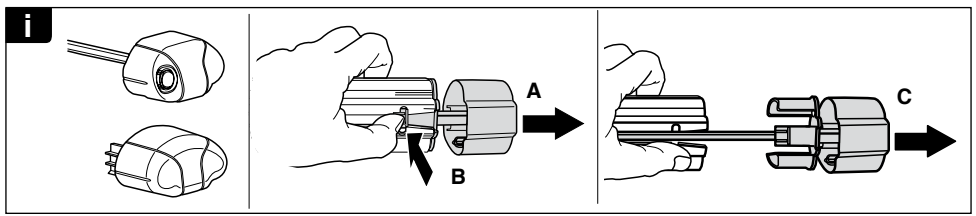
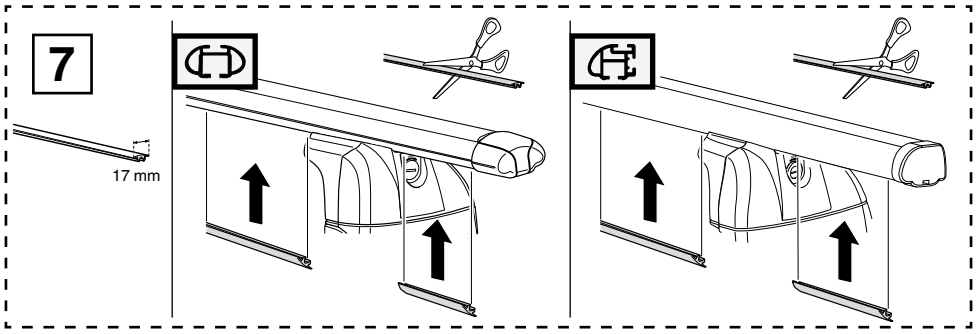

THULE
SWEDEN
**ONE
KEY
SYSTEM**

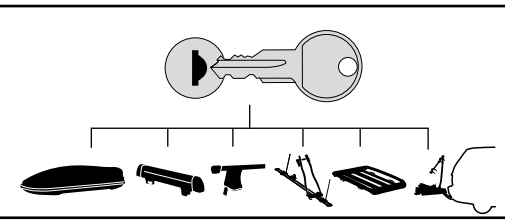

- 544 (x4)
- 596 (x6)
- 588 (x8)
- 510 (x10)
- 518 (x10)
- 452 (x12)