



Thule XT Kit 3134

> Instructions

TOYOTA Highlander, 5-dr SUV, 14-

TOYOTA Kluger, 5-dr SUV, 14-

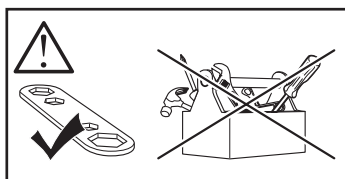

This kit is only for vehicles with fixpoint mounting.

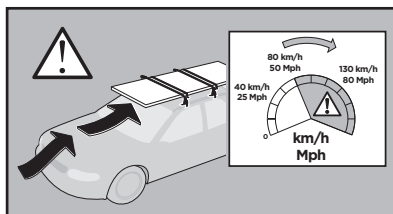
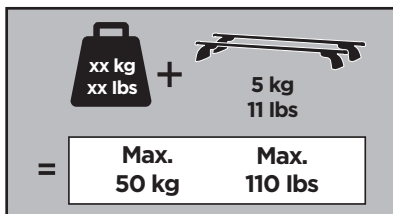
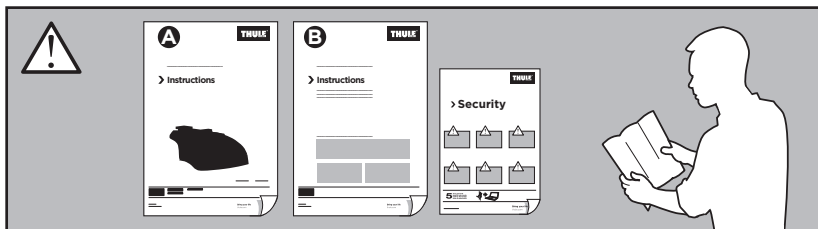

ISO 11154-E

183134

C.20160113
509-3134-02

Bring your life
thule.com

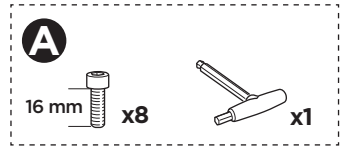
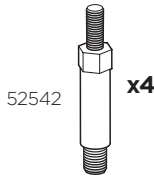
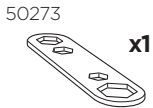
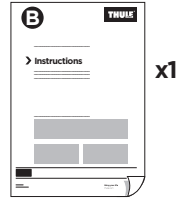
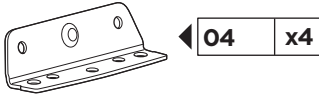

1

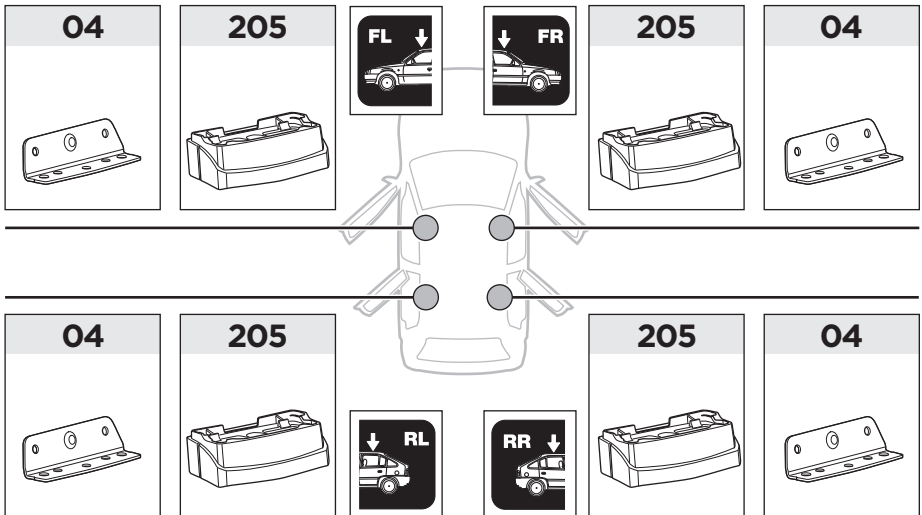

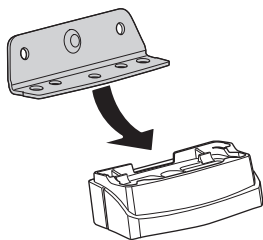
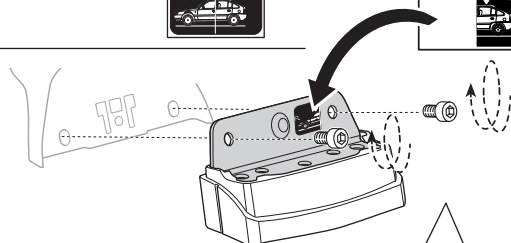
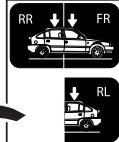
2 A**B** A 16 mm x8

| | | | |
|-------------------------------------|-------------------------------------|----------------------------------|---------------------------|
| EN Only a few turns | ET Ainult mõni pööre | RO Doar câteva rotiri | AR بعض دورات فقط |
| DE Nur wenige Umdrehungen | LV Tikai daži apgriezieni | HU Csak néhány fordítás | HE רק מספר סיבובים |
| FR Quelques tours uniquement | LT Tik keli pasukimai | EL Μόνο λίγες περιστροφές | |
| NL Slechts enkele slagen | PL Wystarczy kilka obrotów | TR Yalnızca birkaç tur | |
| IT Solo qualche giro | RU Только несколько оборотов | | |
| ES Sólo algunas vueltas | UK Лише декілька обертів | ZH 仅几圈 | |
| PT Noções básicas | BG Само няколко завъртания | JA 2～3回転のみ | |
| SV Endast några varv | CS Pouze několik otáček | KO 몇 번만 돌리면 됨 | |
| DK Kun nogle få omgange | SK Len niekoľko otáčok | TH เพียงสองสามรอบ | |
| NO Bare noen få omdreininger | SL Le nekaj obratov | | |
| FI Vain muutama kierros | HR/BiH Samo nekoliko okreta | | |

3