

2021-2023 Ford F-150 5.0L ROUSHcharger Kit

Installation Instructions
P/N: 422240 (1121-6006P1)
422310 (1121-DAFEAD)



12170 Globe St., Livonia, MI 48150 | [800.59.ROUSH](tel:80059ROUSH)

2021-2023 Ford F-150 5.0L ROUSHcharger Kit Installation Instructions

P/N: 422240 (1121-6006P1)

EO D-418-45 : 2021 MODEL YEAR APPLICATION ONLY



Application: 2021-2023 Ford F-150 with 5.0L 4-Valve Engine and Automatic Transmission.

Pro Power onboard/ Dual alternator vehicles must purchase additional installation kit PN: 422310

Important Notes:

- Before installing your F-150 ROUSHcharger Kit, please read the installation manual and verify that all items are present. If you are missing hardware or have any questions, please contact ROUSH Performance at 1-(800) 59-ROUSH.
- Premium fuel (91 octane or higher) is required to prevent "spark-knock" or detonation under certain operating conditions. Fill vehicle with premium prior to supercharger installation.
- Once this modification has been completed this vehicle is no longer capable of running E85 (it is no longer a flex-fuel vehicle).
- Operating your engine without the ROUSH PCM recalibration will result in engine damage or failure and will void your warranty.
- The use of fuel additives (i.e. octane boosters) is not recommended. There is a possibility that these chemicals can damage your engine and cause driveability issues with your vehicle.
- Spark plug required for F-150 ROUSHcharger: M-12405-50VDE (HYFS 092YPT) to prevent "spark knock" or detonation and warranty coverage.
- 5W50 oil required for ROUSHcharger kit. ROUSH recommends the use of Castrol 5W50 SN+ oil.

Table Of Contents

Packing List for 422240 (1121-6006P1) ROUSHcharger Kit..... 4

Equipment and Supplies Required 8

Glossary of Terms 9

Information About the Supercharger Bypass Operation..... 9

Limit of Liability Statement 9

Safety Precautions..... 9

Section A – Disassembly 10

LTR Disassembly 18

Section B – Modifications 22

A/C Compressor Pulley Replacement..... 22

Crankshaft Pulley Replacement 23

Vapor Management Line Modification..... 24

Front Cover Modification 25

Intercooler Pump Harness Procedure..... 26

Harness IAT-1 Procedure..... 27

MAP/MCT Sensor Harness..... 30

Fuel Pump Voltage Regulator (FPVR) 32

Knock Sensor Orientation Adjustment..... 35

Changing the Factory Spark Plugs..... 37

LTR Modification 39

Section C – Subassembly 41

Air Box Assembly 41

Clean Air Tube Assembly 42

Intake Manifold Build Up 43

Supercharger Build Up..... 43

Fuel Rail Assembly..... 44

Intercooler Hard Line Assembly 45

Section D – Installation 47

Heater Tube Install..... 47

Intake Manifold and Fuel Rails 47

Upper FEAD Bracket..... 50

Supercharger 52

PCV Purge Hose 56

Lower FEAD Assembly..... 56

Heater Bracket Mounting..... 58

Intercooler Reservoir Mounting..... 59

Intercooler Pump Mounting..... 60

Coolant Hoses 61

LTR Installation..... 63

Air Induction System..... 65

Section E – Final Assembly..... 66

PCM Flashing 67

Section F – Templates 69

Appendix A Heater Hose Modification 71

Appendix B Module Programming 73

Appendix C End of line Procedure..... 76

Appendix D Dual Alternator Thermostat Installation (pro power onboard only) 80

Appendix E Dual Alternator Intercooler Lines Installation (pro power onboard only)..... 83

Appendix F Hydrocarbon Trap Relocation..... 85

PACKING LIST FOR 422240 (1121-6006P1) ROUSHCHARGER KIT

Description	Part Number	Quantity
Air Induction		
Airbox Tray	1115-9A612	1
Upper Airbox Cover Assembly	1118-9643HC	1
MAF Tube	1115TT-12B579	1
Air Filter - Dry	131550-9601R	1
Tube - Clean Air	1118SC-9B660	1
Hardware Kit Air Induction	1118-TVSHWKA	1
Coupler - MAF-to-CAT	1115SC-9B661	1
Coupler - T-Body to CAT	1118SC-9B662	1
Grommet - 5/8" ID	1150-58GRMT	2
Fitting - 5/8" PCV Fresh Air	1311-9N285	1
Fitting - 5/8" To 1/4" Vacuum	SP001048	1
Clamp - 90-110 mm-12 mm, Stainless Steel Band	1368016100	1
Clamp - 64 mm-140 mm	R07130015-13	2
Screw - Self-Tapping M6 x 25 mm	W506976-S437	6
Push Nut- ROUND NO. 10 (Hydrocarbon Trap Retention)	94800A816	4
Bolt - M8 X 1.25 X 25 (MAF Tube-to-Airbox)	W500224-S437	2
Sensor - Air Intake Sensor	DS7A-12A697	1
Intake Manifold Hardware		
Fuel Charging Assembly	PT00040739	1
Supercharger Assembly with 80 mm Pulley (FIFD)	PT00040777	1
Intake Components	1121-HWKD	1
Fuel Rail Assembly	FS00055438	1
Spark Plug (M-12405-50VDE, HYFS 092YPT) (Pack of 8)	FS00056643	1
Hardware Kit Fuel Charging	1121-HWKB	1
Bolt - M8 X 1.25 X 35 Pan Head (Knock Sensor)	92095A292	4
Bolt - M8 X 1.25 X 40 (Supercharger-to-Upper Intake)	161826	8
Bolt - M6 X 1.0 X 20 (Fuel Rail-to-Upper Intake)	BM6X100X20HF-S437	1
Bolt - M6 X 1.0 X 45 (Fuel Rail-to-Cylinder Head)	161817	1
Gasket - T-Body	FS00056840	1
Bolt - M6 X 1.0 X 40 (Upper Intake-to-Cylinder Head)	R18020004-00-S439	6
9" Sleeving	1320-15799SLV-AB	1
FEAD		
Hardware Kit FEAD	1121-HWKC	1
Pulley - 6K Grooved Idler - 76 mm	FS00057912	2
Pulley - Idler Smooth 70 mm	34-0284	2
Bolt - M8 X 1.25 X 50 (Upper FEAD-to-Intake)	W500313-S437	2
Bolt - M8 X 1.25 X 22 (Idler)	FS00058042	3
Bolt - M8 X 1.25 X 60 (Upper FEAD-to-Engine)	11116346	6

Description	Part Number	Quantity
FEAD Components	1121-HWKC	1
FEAD Bracket - Upper	PT00040867	1
FEAD Tensioner	FS00056749	1
Serpentine FEAD Belt - 1st Sheave 6K	K060810	1
5.0L F-150 Crank Damper	FS00058248	1
F-150 AC Compressor Clutch/Pulley Assembly	147350-7450	1
Bolt - M12 X 1.5 X 110 (Crank Damper)	BR3Z-6A340-A	1
Bracket - Electric Water Pump Mount (Heater Circuit)	PT00038880	1
Bracket Idler Mounting	PT00040860	1
PCV and Vacuum		
PCV Purge Hose - Valve to Spacer	PT00040960	1
PCV Bubbler - Lower Intake to SC	PT00042079	1
Hardware Kit PCV	1121-HWKD	1
3/8" Hose - BEVIS 15.5 inch length	PT00040973	1
Hose - Supercharger Bypass to Supercharger	1318-9E498	1
Clamp - 3/8" worm drive (BEVIS Hose)	62003	4
75 mm X 43 mm Foam Pad, Single-Sided V710 Material	M19-013-0066	1
Wiring		
Wiring Hardware Kit	1121-HWKE	1
Harness - IAT1 Jumper	PT00040445	1
Electrical Jumper - I/C Pump	PT00042003	1
MAP/MCT Sensor Jumper Harness	PT00042001	1
Harness - FPVR Jumper	PT00042352	1
FPVR (Fuel Pump Voltage Regulator)	1315-FPVRKIT	1
Tape - FPVR (165 mm x 12 mm)	FS00052419	1
Screw - M6 X 1.0 X 20 (I/C Pump Relay)	W00214-S437	1
Zip Tie w/ Edge Biter	156-00865	10
J-Clip - M6 X 1.0 (I/C Pump Relay)	N62332-S439	1
Pack of Zip Ties (25)	CTUV740	25
Decals/Labels/Instructions		
Hardware Kit - Paperwork	1121-HWKF	1
Supercharger Badge	PT00041667	1
Decal - Premium Fuel Only (Fuel Door)	13109A095	1
Decal - 2021 Belt Routing and Vacuum (Under Hood)	PT00038645	1
Decal - Premium Fuel Only (Cluster)	R07110004-11	1
Decal - PCM (Under Hood)	R07100008-10	1
RDT Voucher Card	P1121-P1CAL	1
Sticker 5W-50 (Oil Fill Cap)	1318-5W50ST	1
Label - Spark Plug Warning	PT00045644	2
Limited Powertrain Warranty	336PTW	1
EO Label - 21MY F-150 SC	D41845-9A095EO	1

Description	Part Number	Quantity
Intercooler System - Tubes, Hoses and Clamps		
Hose - 3/4" Intercooler Reservoir Inlet	PT00040444	1
Hose Assembly - 3/4" Intercooler Pump Inlet	PT00040587	1
Hose Assembly - 3/4" Low Temp Rad Outlet	PT00040588	1
Hose Assembly - 3/4" Intercooler Pump to LTR	PT00040441	1
3/4" Hose Assembly Jumper	PT00040589	2
CAC Hard Line Assembly	PT00040591	1
Electric Water Pump I/C, Without Brackets (0392024078)	FS00057975	1
Reservoir - F-150 Supercharger Degas	1115-8D028	1
Low Temperature Radiator Assembly	PT00037909	1
Degas Bottle Cap	9C3Z-8101-B	1
Bracket - Degas Bottle to Fan Shroud	PT00041029	1
Bracket - Inter Cooler Pump Mounting	1118-8C4191	1
Tube Assembly Water Bypass	PT00038883	1
Intercooler Pump Bracket	PT00041036	1
Hardware Kit Intercooler	1121-HWKG	1
Clamps - 3/4" Hoses (Constant Tension)	CT19x12-BO	12
Screw - M6 X 1.0 X 20 (Degas Bottle-to-Fan Shroud)	W500214-S437	2
Nut - M6 X 1.0 (Degas Bottle)	W520412-S437	2
J-Clip - M6 X 1.0 (Degas Bottle)	N623332-S439	1
Bolt - M8 X 1.25 X 33 (I/C Pump Bracket)	N808920-S437	2
J-Clip - M8 X 1.25 (I/C Pump Bracket)	W520823-S439	2
Grommet (Rubber Grommet LTR Isolator)	R07060107-13	3
Washer - M8 X 24 (LTR-to-Active Grill Shutter)	FT00000528	4
Bolt - M8 X 1.25 X 16 (LTR-to-Active Grill Shutter)	FS00056117	4
Hardware Kit Heater Hose	1122-HWKA	1
Straight Connector - 3/4-3/4	28605	1
Clamp - 3/4" Hoses (Constant Tension)	CT19x12-80	2
Intercooler Hose- 3/4" LTR Outlet	1115-80030	1
Spacer - Dual Swivel Saddle Bund	151-06500	2
8" Zip Tie	CTUV840	4
Dual Alternator Supplemental Kit (PURCHASED SEPARATELY)	422310	
Thermostat Housing	PT00048357	1
Bracket - Degas Bottle to Fan Shroud	PT00041029	1
Hose - Upper Radiator	PT00048095	1
Hose Asy, 3/4" Intercooler Reservoir Inlet	PT00048097	1
Hose Asy, 3/4" Low temp rad outlet	PT00048098	1
Hose asy, 3/4" Intercooler Pump Inlet	PT00048374	1
Bracket - Hose Support	PT00048729	2

Description	Part Number	Quantity
Dual Alternator Supplemental Kit (PURCHASED SEPARATELY) CONTINUED.		
Bolt- M6 X 1 X 20 (Hose mounting bracket to sc)	BM6X100X20HF-S437	2
Zip Tie 8" Black	CTUV840	6
Saddle - Zip Tie	151-06500	2
Hardware Kit -	1121-HWKDUAL	1
Clamp - Radiator Hose	SP001491	3
O-Ring Thermostat Gasket	FS00061701	1
Gasket - Water Pump	FS00061699	1
Gasket - Cylinder Head to water tube flange	FS00061700	1
Fitting - NPT To hose barb	SP001490	1
Fitting - Radiator	FS00061905	1

EQUIPMENT AND SUPPLIES REQUIRED

- Cordless Impact Wrench
- 1/4" and 3/8" Drive Ratchets with Extensions
- Metric and Standard Socket Sets (short and deep recommended)
- 1/2" Drive Ratchet or Breaker Bar with 3/8" adapter
- Metric and Standard Wrench Sets
- 3/8" Drive Torque Wrench (7-35 ft-lb range)
- Assorted Standard Flat Screwdrivers
- T-30 Torx Bit Screwdriver or Socket
- Grinder/Cutoff Wheel (Angle Grinder/Dremel)
- Coolant (meeting Factory Ford specification for 2021 F-150)
- 6" Scale, Tape Measure, or Other Measuring Device
- Assembly Lubricant (White Lithium Grease or Petroleum Jelly)
- Electrical Tape
- Sharp Knife or Razor Blade
- Trim Tool
- Trim Pad Tool (for push pin removal)
- Fender Cover (2)
- Medium Strength Thread Locker - Loctite 242 (Blue) or equivalent
- Rust Preventative
- Isopropyl Alcohol
- 14 mm Spark Plug Socket
- Electrical Terminal Extractor Tool
- 5 mm Hex Bit
- Pliers
- Feeler Gauges
- Engine Damper Removal/Install Tool
- AC Pulley Puller
- RTV
- 5W-50 oil (ROUSH recommends the use of Castrol 5W50 SN +)
- 3/8" 18-24 in. Hose For Coolant Drain
- Drill and 1/4 ", 3/8" and 9/16" drill bits
- Anti Seize Compound

GLOSSARY OF TERMS

ACT	Air Charge Temperature Sensor (IAT1) located in the intake air tube in this kit.
ETC	Electronic Throttle Control
MCT	Manifold Charge Temperature Sensor
PCM	Powertrain Control Module (a.k.a. ECM, ECU, PCU, EEC)
PCV	Positive Crankcase Ventilation
T-MAP	Manifold Absolute Pressure and Temperature Sensor
TPS	Throttle Position Sensor
RDT	ROUSH Diagnostic Tool
VMV	Vapor Management Valve (aka Canister Purge Valve)
Breakout Point	A place in an electrical harness where the wiring for an individual component leaves (breaks out of) the main harness to attach to an individual component.

INFORMATION ABOUT THE SUPERCHARGER BYPASS OPERATION

There is a great deal of misinformation about the function of supercharger bypass systems. The supercharger is a positive-displacement pump; that is, so long as it is rotating, it is always pumping air. During low demand or high vacuum operation (i.e. idle, deceleration, and light throttle cruise), the pumping action is undesirable as it creates unwanted heat and noise. The bypass circuit, when open, prevents any pressure buildup across the supercharger and allows air to circulate through the rotors, allowing the supercharger to "idle" freely during these conditions. This results in reduced noise, and by reducing heat buildup in the intake, significantly improves street and strip performance. As throttle demand increases, the bypass circuit is closed, resulting in full performance from the supercharger. The bypass circuit is never used to limit or control boost during full-throttle operation and defeating or altering the bypass function will not result in improved performance in any condition, and will result in poor driveability.

LIMIT OF LIABILITY STATEMENT

The information contained in this publication was accurate and in effect at the time the publication was approved for printing and is subject to change without notice or liability. ROUSH Performance Parts reserves the right to revise the information presented herein or to discontinue the production of parts described at any time.

SAFETY PRECAUTIONS



CAREFULLY READ THE IMPORTANT SAFETY PRECAUTIONS and WARNINGS BEFORE PROCEEDING WITH THE INSTALLATION!

Appropriate disassembly, assembly methods and procedures are essential to ensure the personal safety of the individual performing the kit installation. Improper installation due to the failure to correctly follow these instructions could cause personal injury or death. Read each step of the installation manual carefully before starting the installation.

- Always wear safety glasses for eye protection.
- Place the ignition switch in the OFF position.
- Always apply the parking brake when working on the vehicle.
- Block the front and rear tire surfaces to prevent unexpected vehicle movement.
- Operate the engine only in well-ventilated areas to avoid exposure to carbon monoxide.
- Do not smoke or use flammable items near or around the fuel system.
- Use chemicals and cleaners only in well-ventilated areas.
- Batteries can produce explosive hydrogen gas which can cause personal injury. Do not allow flames, sparks or flammable sources to come near the battery.
- Keep hands and any other objects away from the radiator fan blades.
- Keep yourself and your clothing away from moving parts when the engine is running.
- Do not wear loose clothing or jewelry that can be caught in rotating or moving parts.

SECTION A – DISASSEMBLY

The following section will guide you through the disassembly of the stock components. Special care should be taken to label fasteners and parts that are taken off during this procedure since many will be reused:

1. Cover both fenders with fender covers to protect the vehicle finish.
2. Blow off engine bay with compressed air prior to disassembly.
3. Release the fuel system pressure.

NOTE: The following procedure is taken directly from the Ford Service Manual.

WARNING

Fuel in the fuel system remains under high pressure even when the engine is not running. Before working on or disconnecting any of the fuel lines or fuel system components, the fuel system pressure must be relieved. Failure to do so can result in personal injury.

WARNING

Do not smoke or carry lighted tobacco or open flame of any type when working on or near any fuel-related components. Highly flammable mixtures are always present and can be ignited, resulting in personal injury.

- a. Disconnect the fuel pump control module electrical connector. It is located on the frame rail above the rear fuel tank strap.

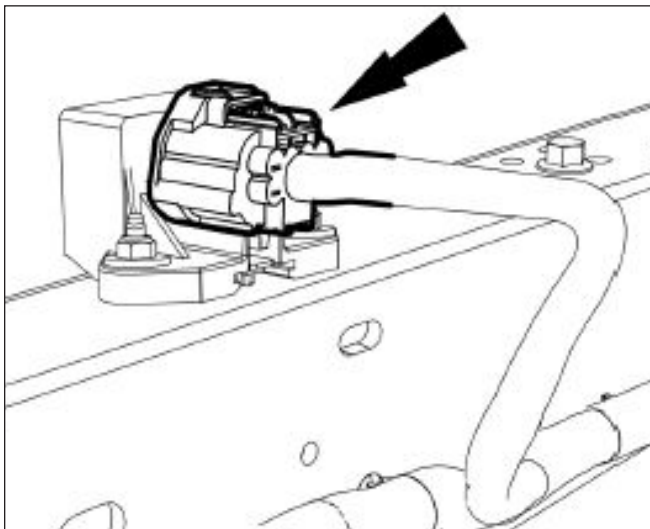

- b. Start the engine and allow it to idle until it stalls.

- c. After the engine stalls, crank the engine for approximately 5 seconds to make sure the fuel rail pressure has been released.
 - d. Turn the ignition switch to the OFF position.
4. Using a 10 mm wrench, disconnect the (-) negative and (+) positive connections to the battery and remove the battery from the vehicle.

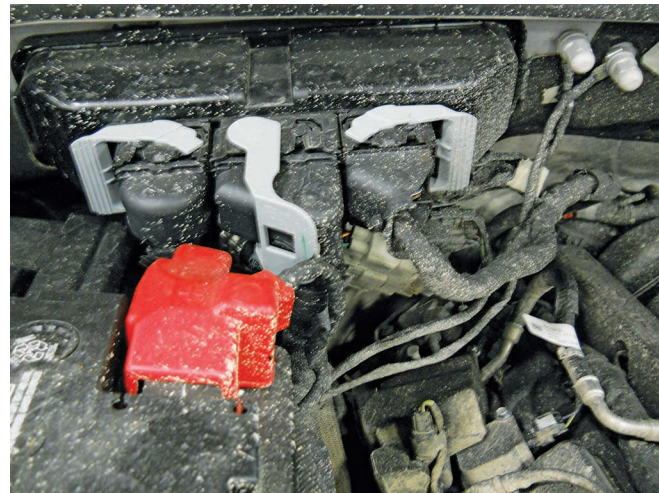

5. With the engine cool, remove the cap on the engine coolant degas reservoir bottle and the upper radiator fill cap. Drain the coolant using the petcock located on the lower passenger side of the radiator. Tighten the petcock once the engine coolant has been drained.

TIP: Connect a 3/8" hose to the drain fitting next to the petcock and run into a clean drain pan or bottle. Use a flat-blade screwdriver to open the petcock and allow the coolant to drain out of the fitting.

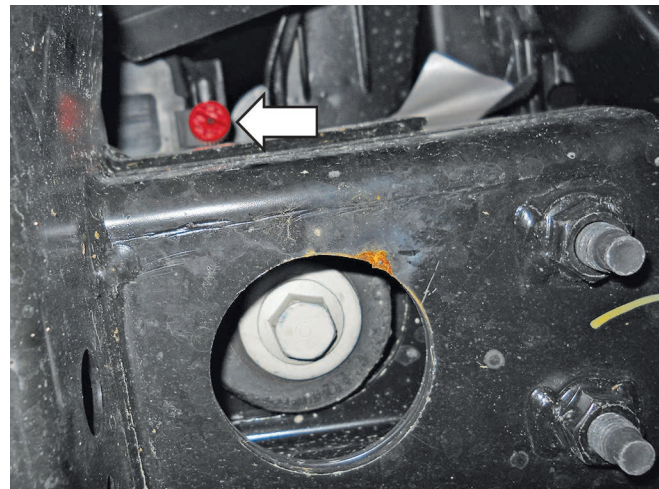

6. Disconnect the PCV fresh air inlet tube from the left-hand (driver side) cam cover and the clean air tube. Remove the hose from the vehicle and save for later use. Disconnect the clean air tube from the throttle body and the upper air box lid. Remove the clean air tube from the vehicle. Remove the T/B clamp to be used for install later. The clean air tube will not be reused.

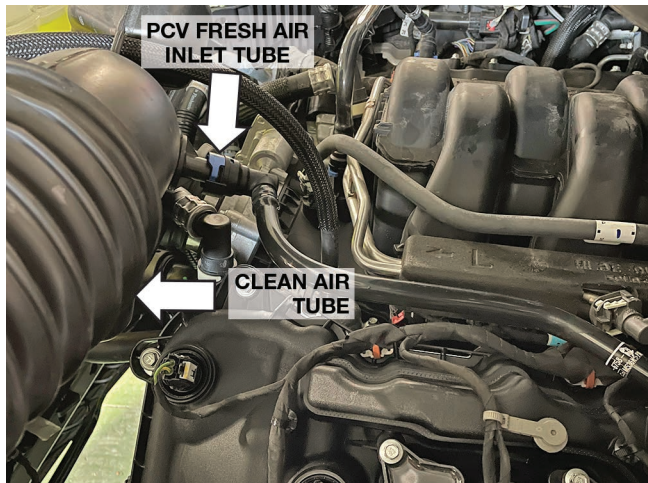

7. Disconnect the heater hose quick connect fitting on the front drive and passenger side of the engine. Position these hoses aside.

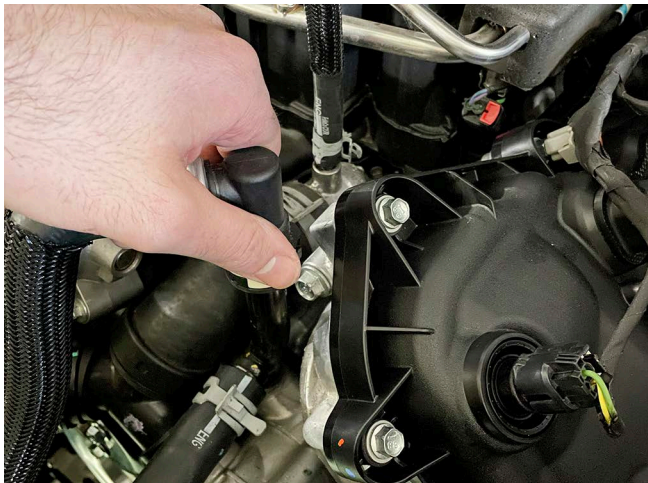

8. Pull up the two (2) retainers on the air inlet duct.



9. Remove the retaining bolt on the RH side of the air box, lift up and remove the air box.





10. Remove the PCV purge line from the intake manifold and passenger side cam cover. This line will not be reused.

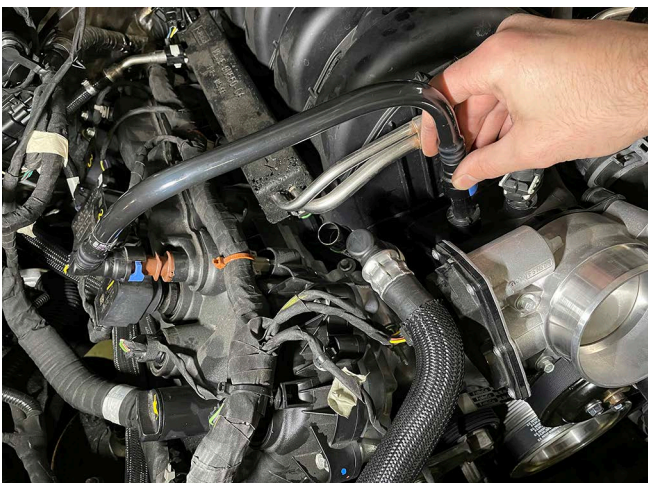

11. Disconnect the throttle body electrical connector as shown. (Pull the red locking tab back; press the black release tab to disengage the lock.) Remove the four (4) throttle body mounting bolts with a 8 mm socket and set the throttle body and fasteners aside for later.

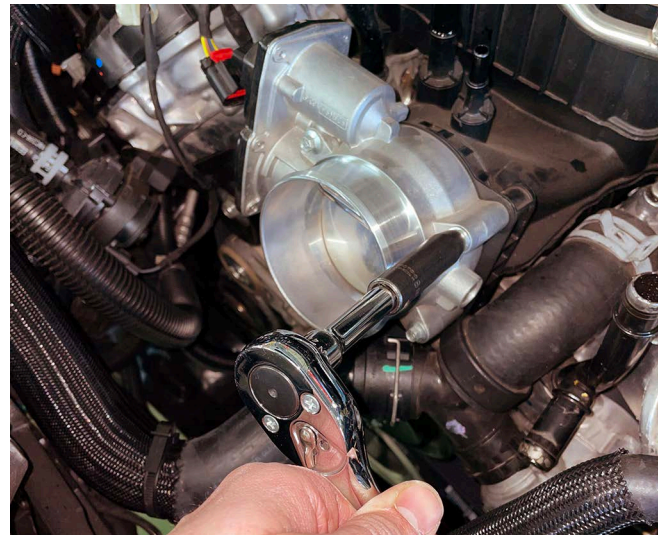

12. Disconnect the VMV (evaporative emission canister purge valve) tube and electrical connector. Remove the VMV tube retainer from the fuel rail and fuel supply line.

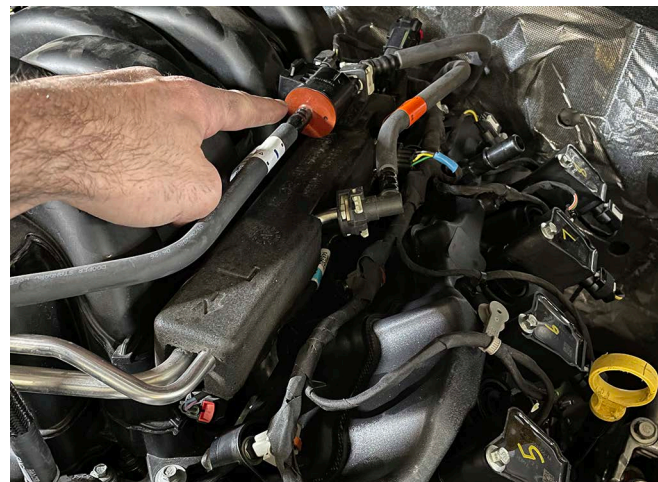

13. Disconnect the fuel supply line on the driver side from the fuel rail as shown. Use rags to catch fuel.

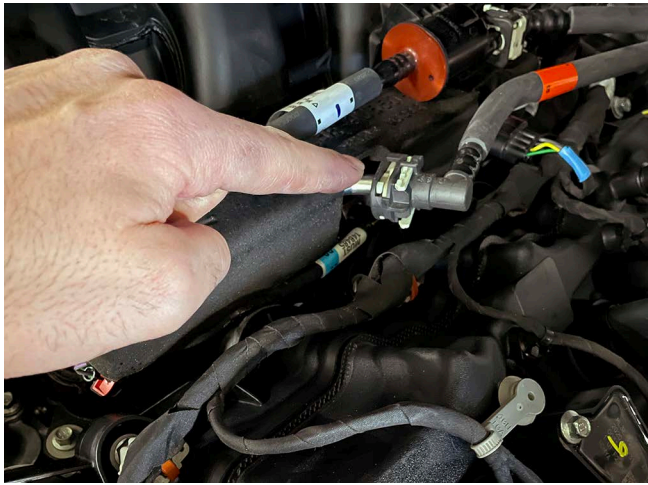

16. Disconnect the degas upper bottle-to-radiator hose.



14. Disconnect the high pressure fuel line (RH side).

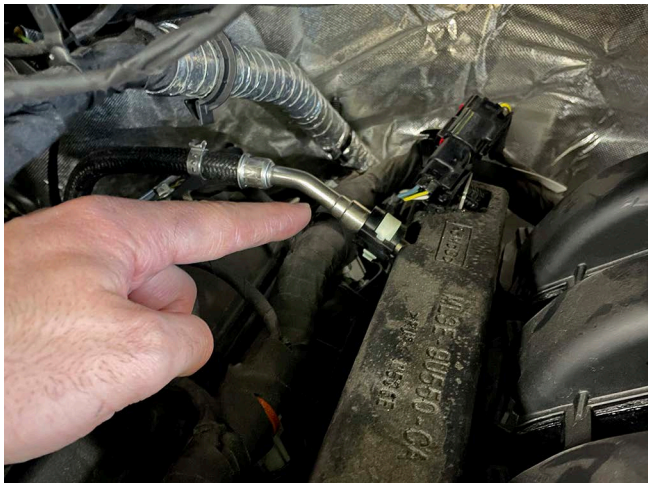

17. Remove the two (2) degas bottle mounting bolts.



15. Remove the 3/8" engine coolant degas hose from the connection at the engine and place the loose end of the hose to the side for later connection.

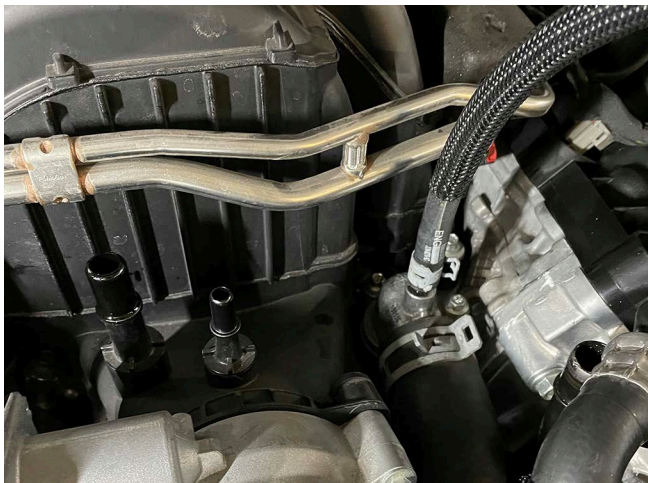

18. Disconnect the degas-to-engine lower hose from the port on the engine and remove the degas bottle from the vehicle.



19. Remove and discard the LH and RH fuel rail insulators.

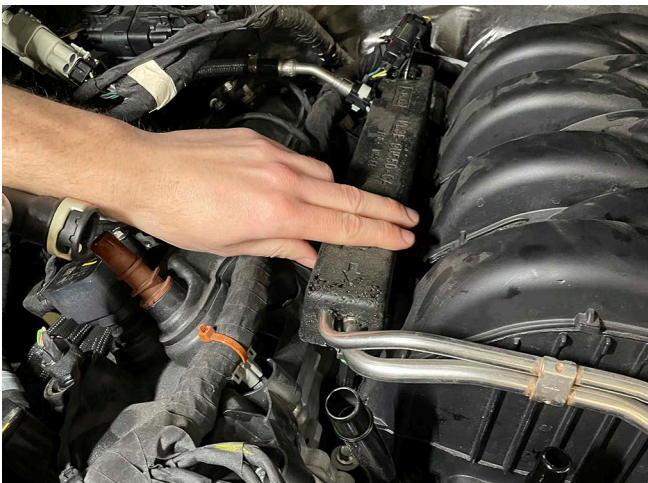

21. Disconnect the fuel regulator electrical connector from the sensor on the LH fuel rail.

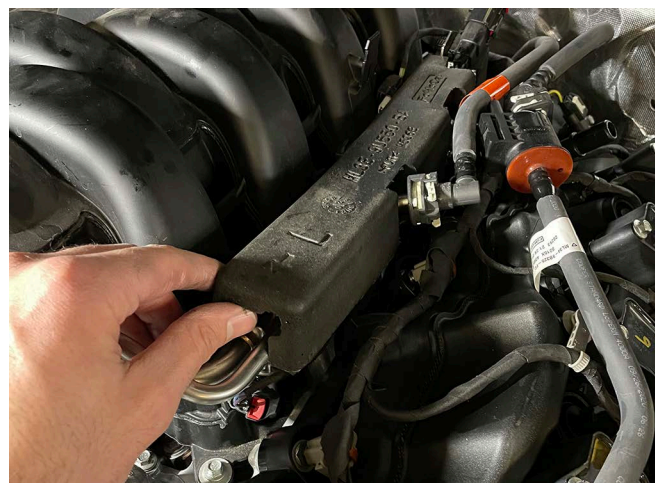
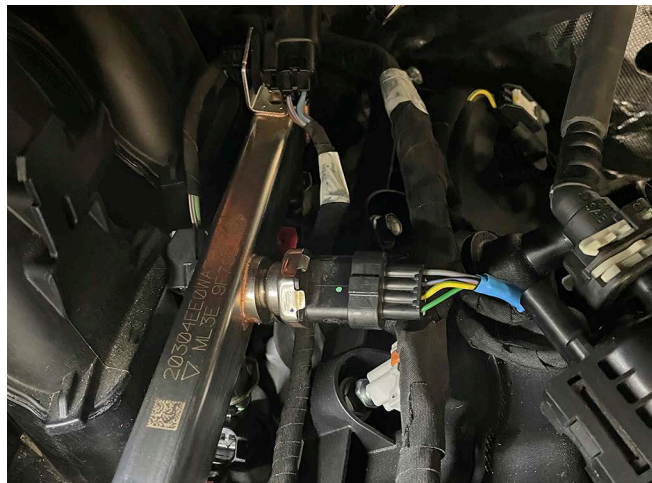

22. Remove the four (4) fuel rail bolts. Three (3) of the four (4) bolts will be reused.

NOTE: Remove the fuel rail from the intake manifold assembly to gain access to intake manifold fasteners. The injectors and clips will be used later in assembly.

20. Disconnect the eight (8) fuel injector electrical connectors.
NOTE: The fuel injector harness can be removed with the fuel rail.

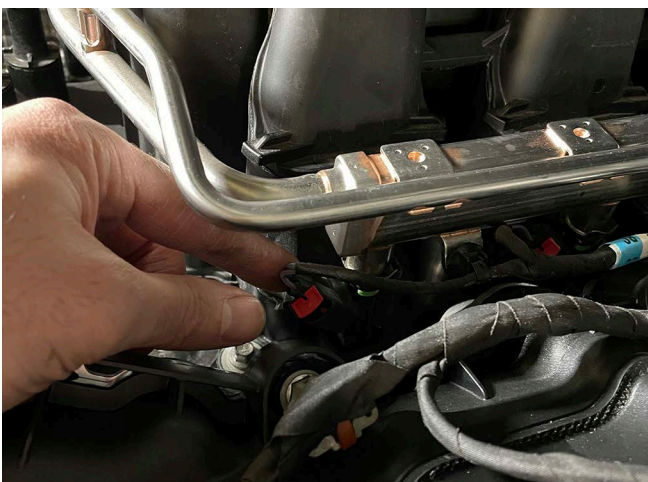
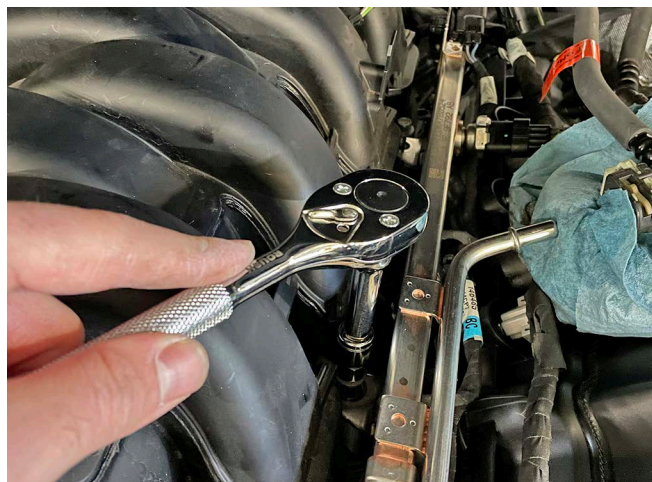

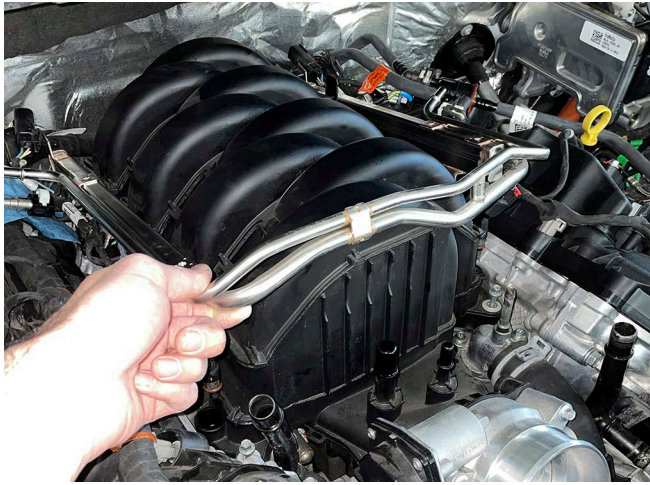

23. Remove the remaining six (6) intake manifold mounting bolts. Lift up and move the manifold forward enough to access and remove the retaining pins attaching the wiring harness at the back of the manifold. Disconnect the MAP sensor electrical connector on the back side of the manifold as shown. Remove and discard the intake manifold. The intake manifold will not be reused.



24. Clean the intake mounting surfaces and apply tape over the open intake ports to prevent engine contamination.

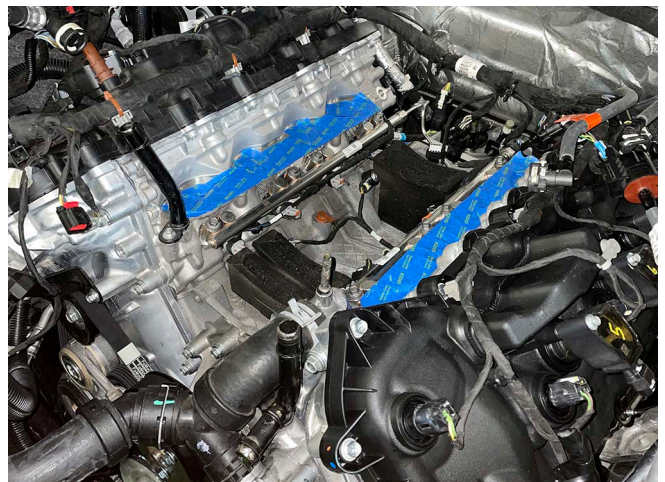

25. Disconnect the upper radiator hose from the engine.

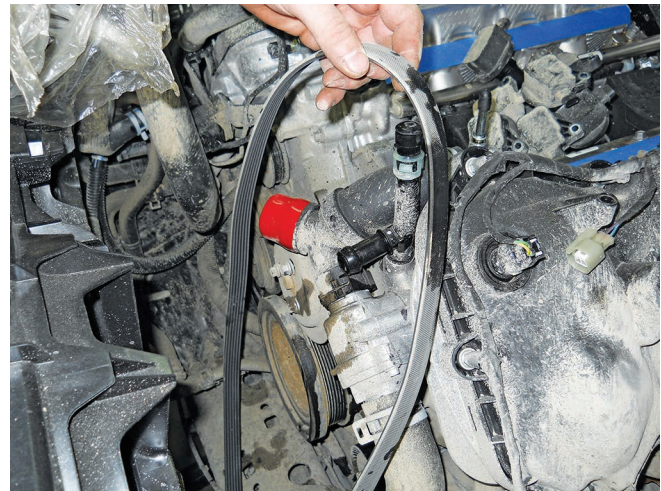
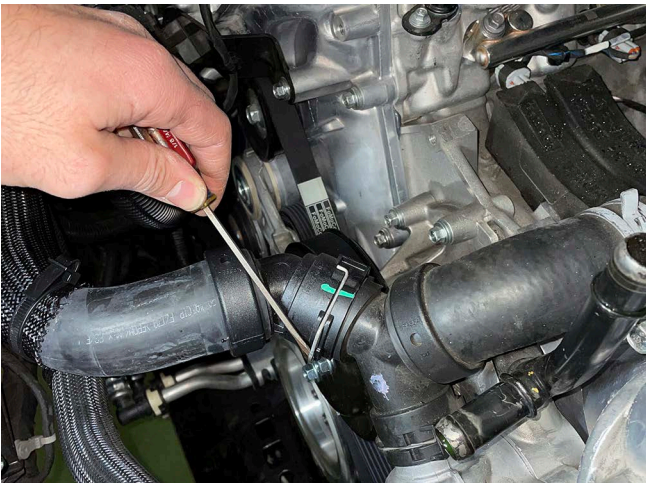
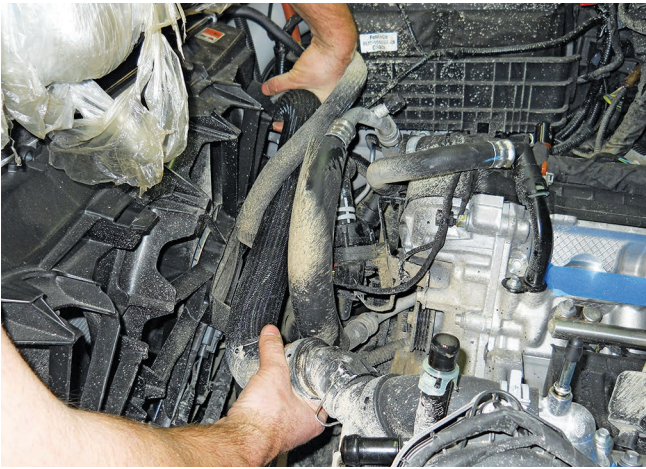

26. Loosen the three (3) water pump pulley bolts, and then remove the front engine accessory drive (FEAD) belt. Rotate the FEAD tensioner counter-clockwise to release the belt tension and remove the belt.

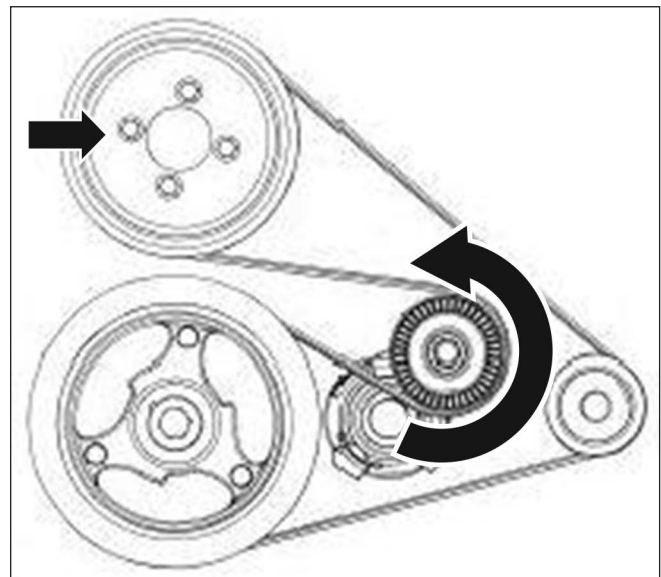
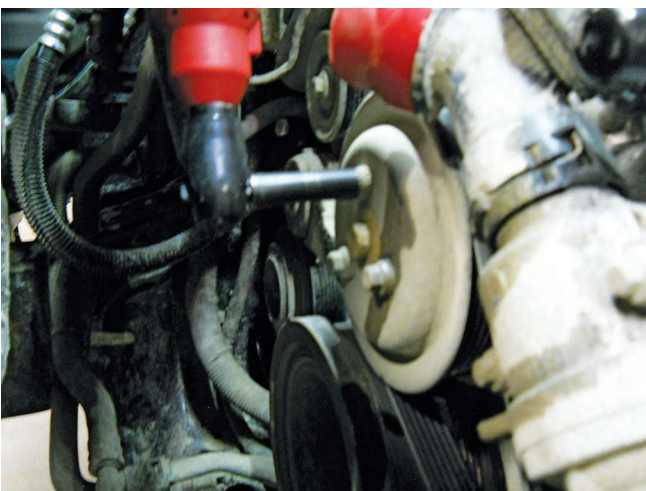

27. Remove the three (3) bolts securing the water pump pulley to the engine.
28. Release the tension and remove the A/C compressor belt from the engine. Then remove the tensioner and the idler; save the tensioner and idler fastener for later, discard the belt, tensioner, and idler pulley.

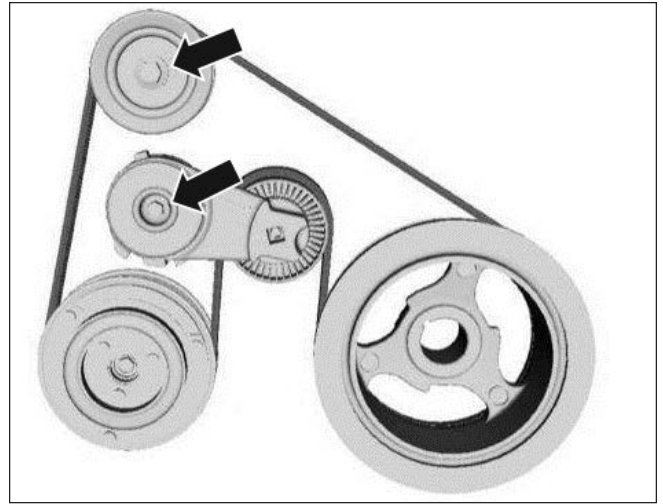
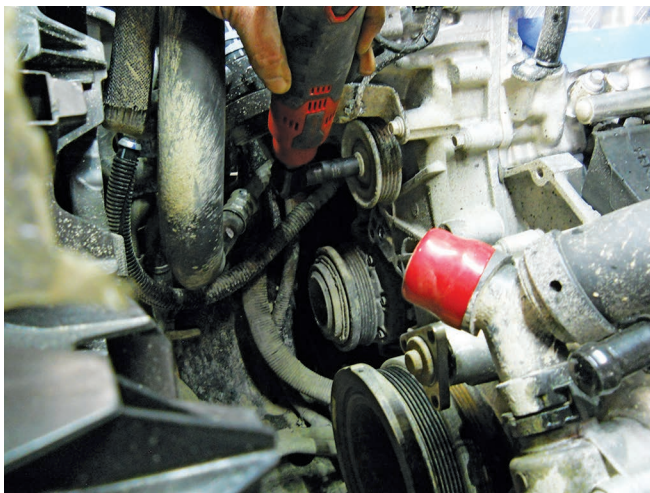

29. If equipped, remove the two (2) auxiliary heater pump bracket fasteners from the front cover. Remove the wire harness push pin and flip the bracket over to reveal two (2) retaining clips. Remove the retaining clips. Zip tie the pump out of the way. The bracket can be discarded. Save the two (2) retaining clips for later.

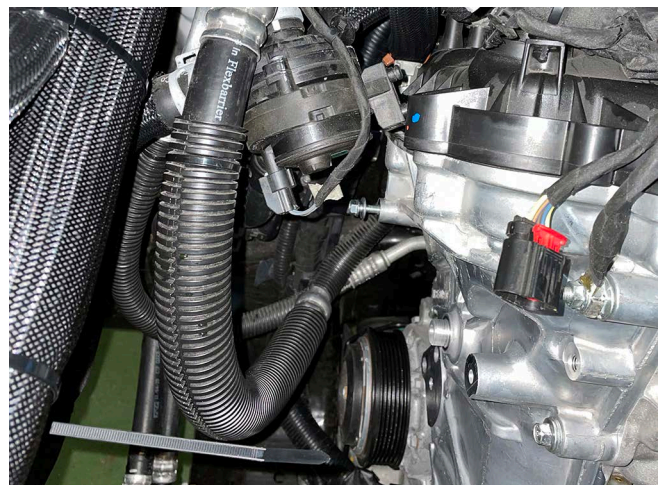
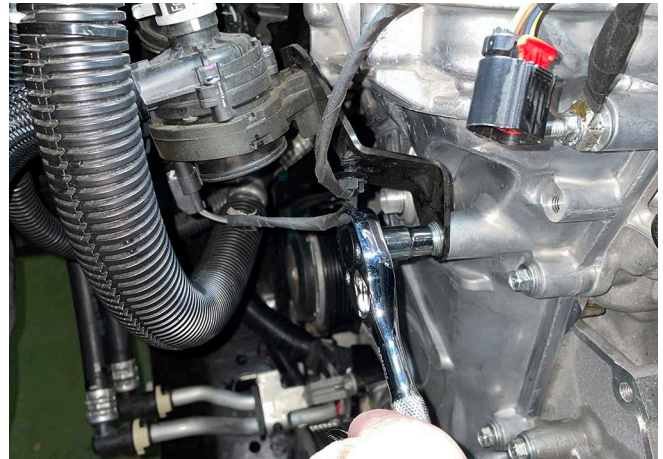

30. Remove and discard the heater tube. Save the fastener for later.



LTR DISASSEMBLY

1. Remove the fourteen (14) push pins on the close out panel with a trim removal tool.



2. If equipped, disconnect the electrical connectors and the washer hose.

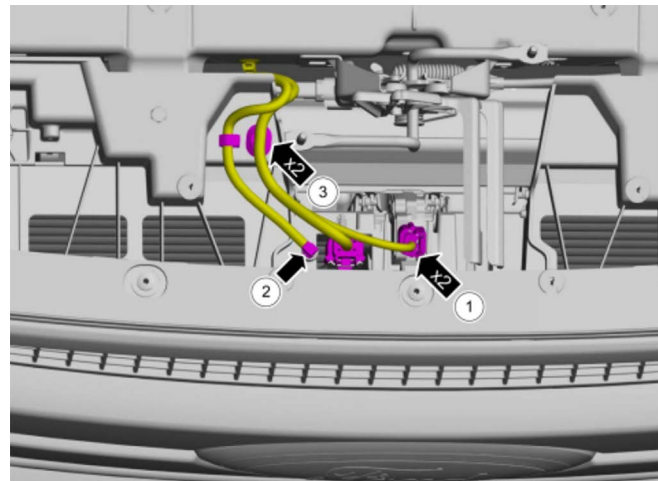

3. Remove the four (4) bolts (two [2] on each side) on the lower grille trim piece, in the wheel well.

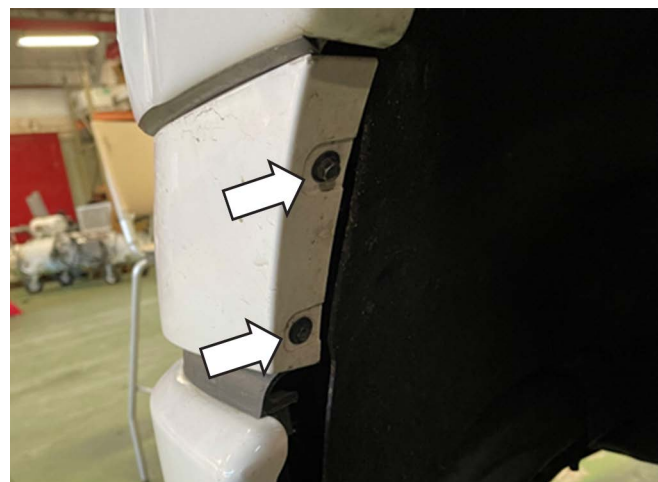

4. Remove the front bumper upper cover trim panel by pulling forward. Set it aside so it is not scratched.

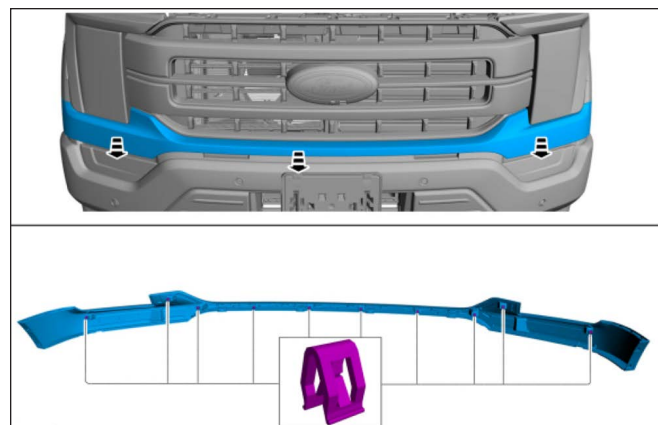

5. Remove the four (4) bolts from the active grill shutter. Remove the two (2) pin-type retainers.



6. Remove the two (2) fasteners in the lower corners from the active grill shutter.



7. Remove the grill and active grill shutter assembly from the vehicle. Note that there are four (4) clip positions on the grill.

NOTE: Place a moving blanket or towels on the work bench to avoid scratching the grill when removed.

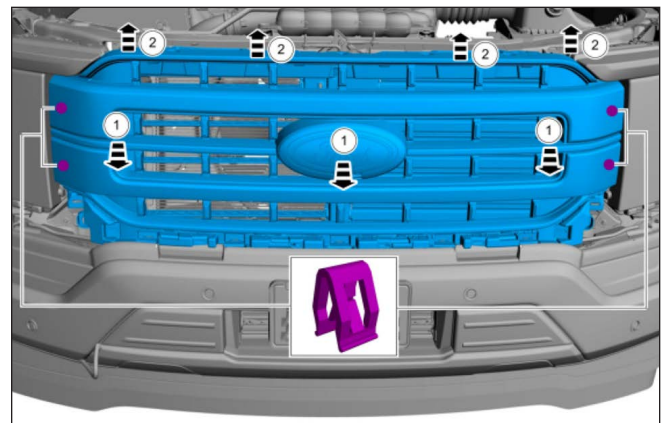

8. Remove the close out panel on the driver side with a trim tool. It will be modified for the routing of the LTR hoses.

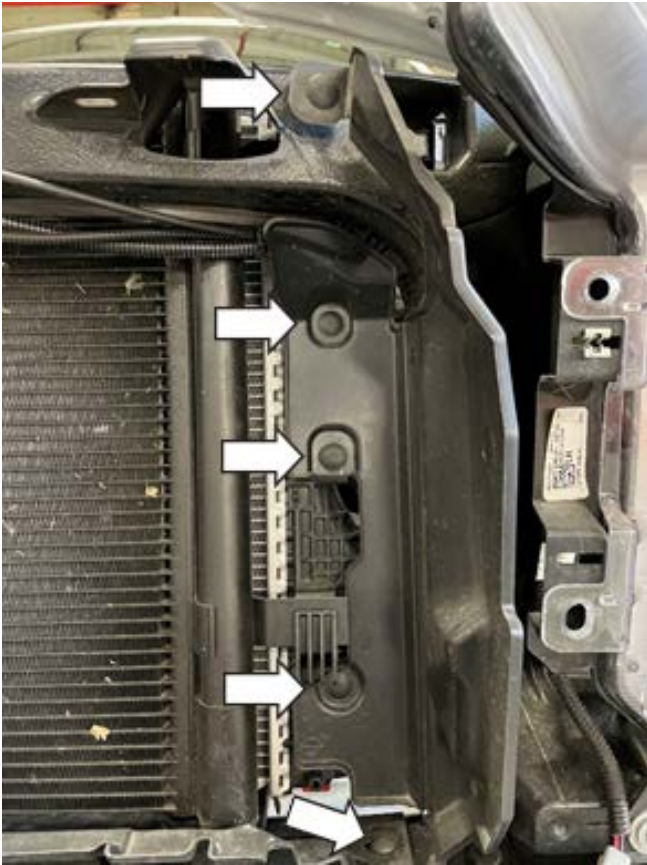

9. If vehicle is equipped with Pro Power Onboard (dual alternator equipped) proceed with the following steps, if Vehicle is NOT equipped with Pro Power Onboard Skip steps 10-14

10. Remove the lower radiator hose clamp. Save clamp for installation later. Tie hose back for work on the thermostat housing removal

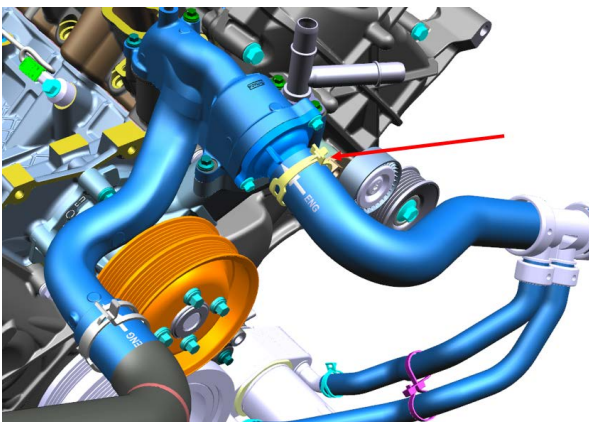

11. Remove upper radiator hose clamps and upper radiator hose (highlighted in yellow). Hose and clamps can be discarded.

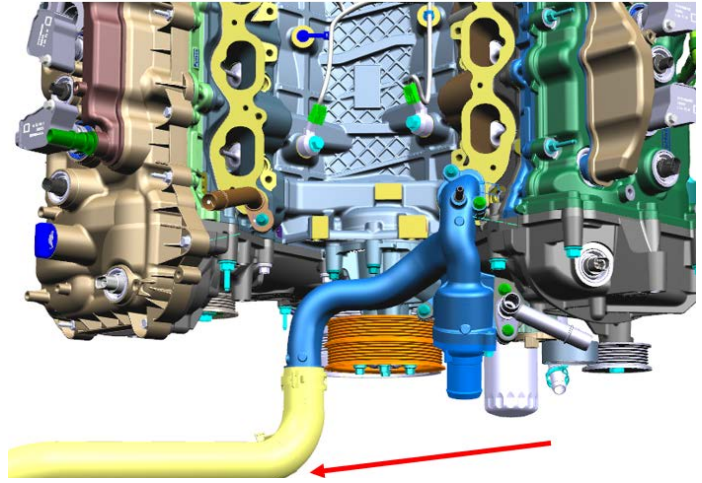

12. Remove connector water inlet and 2 fasteners (highlighted in yellow). Removing the connector water inlet will expose the thermostat (highlighted in yellow). Remove the thermostat and O-ring seal. Save the thermostat, connector water inlet, and the 2 fasteners for later. The O-ring seal can be discarded.

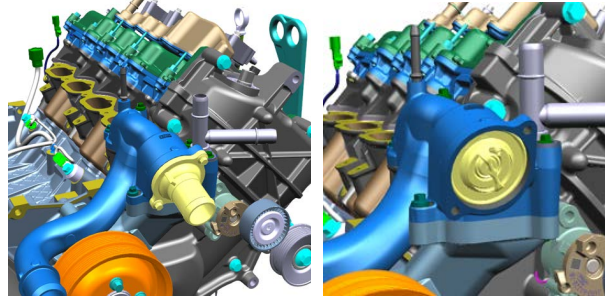

13. Remove Hose Assembly and one fasteners (highlighted in yellow) and save them for installation later.

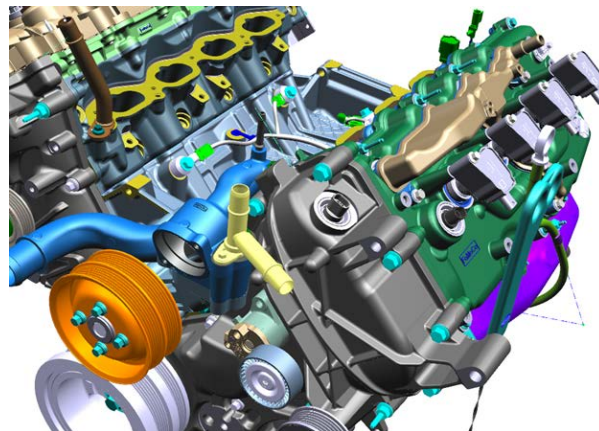

14. Remove the 4 fasteners and the housing – engine thermostat. Save the 4 fasteners for installation later. The housing – engine thermostat can be discarded.

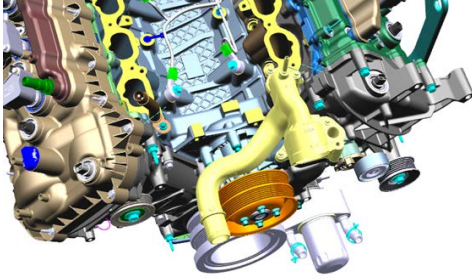

SECTION B – MODIFICATIONS

The following section will guide you through the required modifications of existing components and build up of the assemblies used to complete the installation. With the exception of the wiring modifications and the A/C compressor clutch assembly R&R, all of this work can be performed away from the vehicle.

A/C COMPRESSOR PULLEY REPLACEMENT

A/C Clutch Disc and Hub Bolt Removal

1. Using the A/C Clutch Holding Tool, hold the A/C clutch disc and hub.
2. Remove the A/C clutch disc and hub bolt.

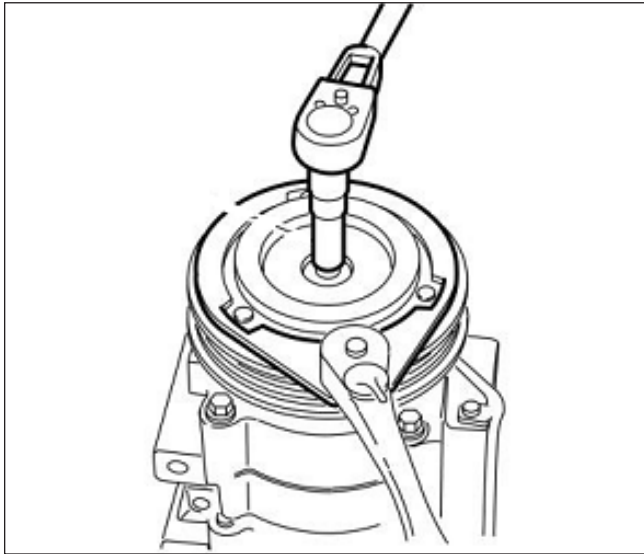

3. Remove the A/C clutch disc and hub.
4. Remove the A/C compressor pulley snap ring.

Compressor Pulley Removal

NOTICE: Do not use air tools. Damage to the air conditioning (A/C) clutch pulley or A/C compressor may result.

1. Install the Compressor Pulley Remover.
2. Remove the A/C compressor pulley.

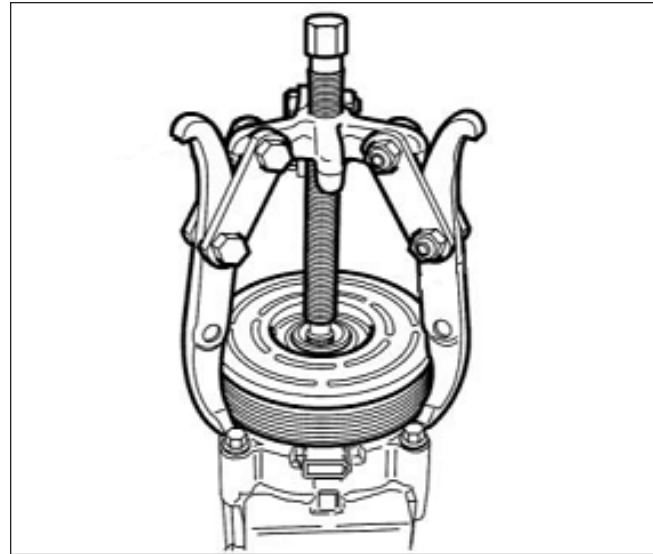

Compressor Pulley Installation

1. Clean the A/C pulley mounting surfaces.

NOTE: The A/C compressor pulley is a tight fit on the A/C compressor. It must be correctly aligned during installation.

2. Install the A/C compressor pulley (147350-7450).
3. Install the A/C compressor pulley snap ring with the bevel side out.
4. Place one (1) nominal thickness A/C clutch disc and hub spacer inside the clutch hub spline opening.

A/C Clutch Disc and Hub Bolt Installation

1. Using the A/C Clutch Holding Tool, hold the A/C clutch disc and hub.
2. Tighten the bolt to 14.5 Nm.



3. Measure and adjust the clutch air gap at three (3) spaces by removing or adding A/C clutch disc and hub spacers.

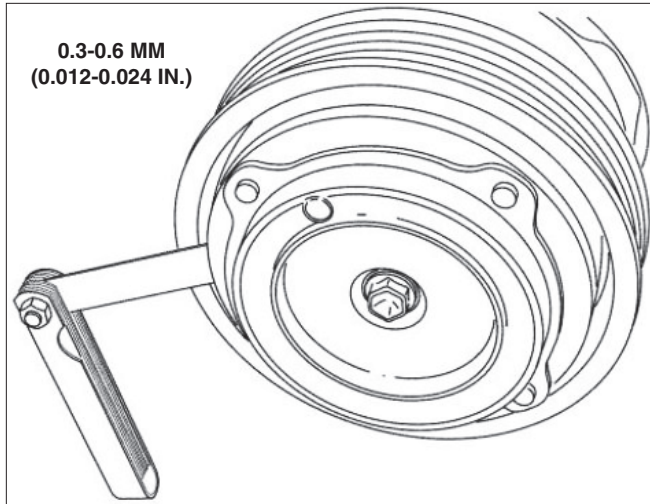

CRANKSHAFT PULLEY REPLACEMENT

NOTE: After the crankshaft pulley installation, it will be necessary to relearn the misfire profile correction using RDT. (This will be completed during flash process.)

Pulley Removal

1. Loosen the crankshaft pulley bolt and washer.

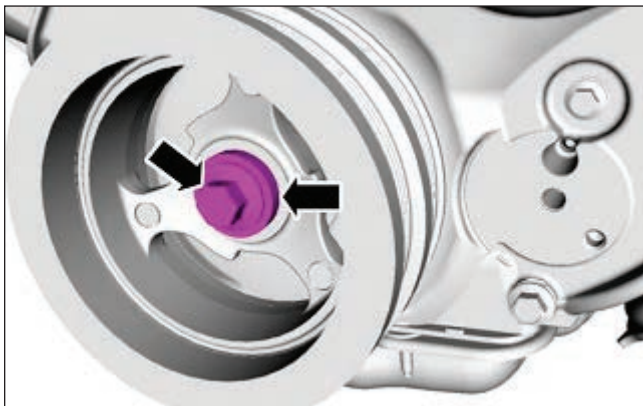

2. Using a 3-Jaw Puller and the crankshaft pulley bolt, remove the crankshaft pulley. Discard the crankshaft pulley bolt.

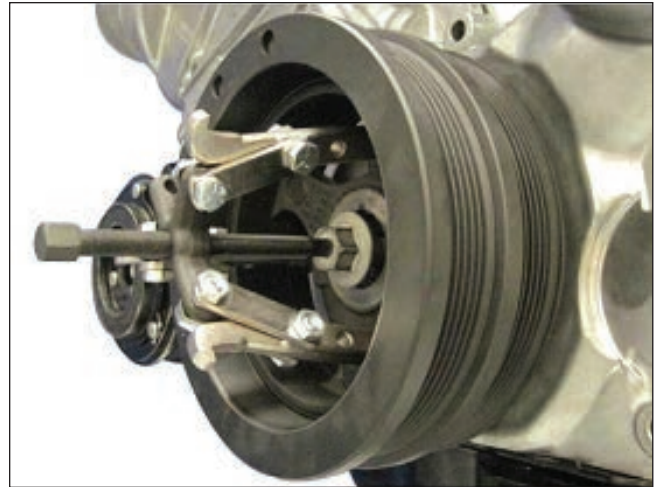

Pulley Installation

NOTE: If not secured within 5 minutes, the sealant must be removed and the sealing area cleaned with silicone gasket remover and metal surface prep. Failure to follow this procedure can cause future oil leakage.

1. Apply silicone gasket and sealant to the Woodruff key slot in the crankshaft pulley (FS00058248).



2. Lubricate the crankshaft pulley sealing surface with clean engine oil prior to installation.

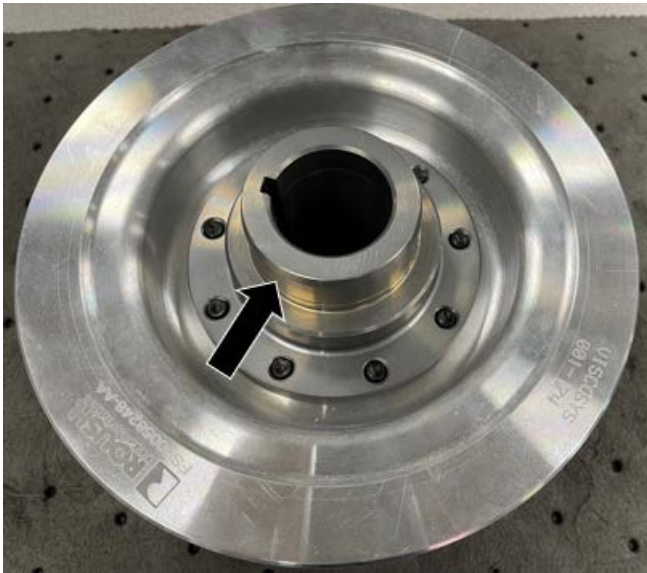

3. Using a suitable damper installation tool, install the crankshaft pulley (FS00058248).

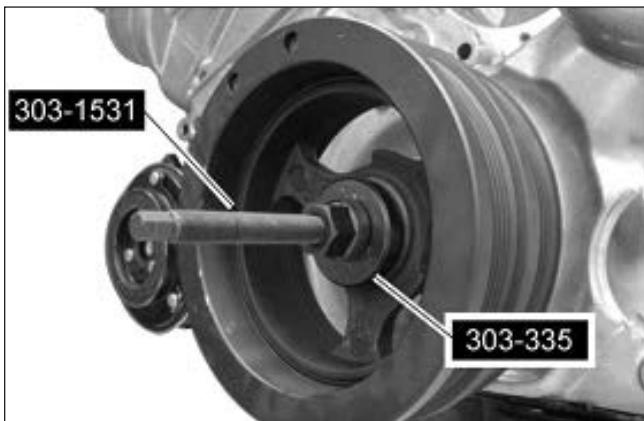

4. Using a Strap Wrench, install a new crankshaft pulley bolt (BR3Z-6A340-A) and the original washer. Tighten the bolt in four (4) stages:
- Stage 1: Tighten to 140 Nm.
 - Stage 2: Loosen 360 degrees.
 - Stage 3: Tighten to 100 Nm.
 - Stage 4: Tighten an additional 90 degrees

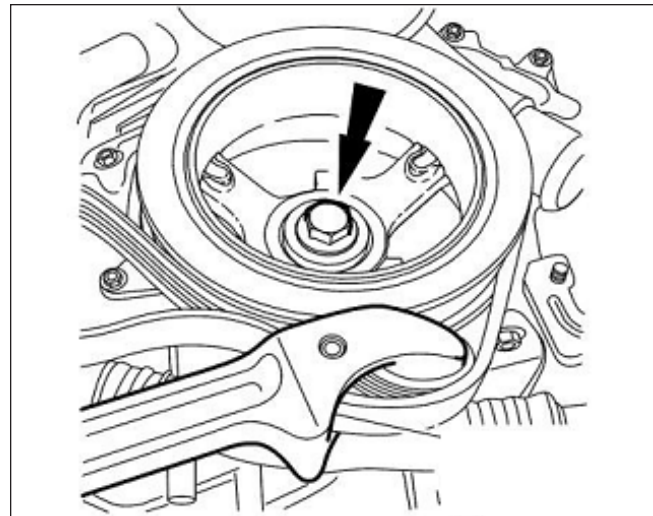

VAPOR MANAGEMENT LINE MODIFICATION

Remove the vapor management hose from the purge valve with a knife. Discard the hose.

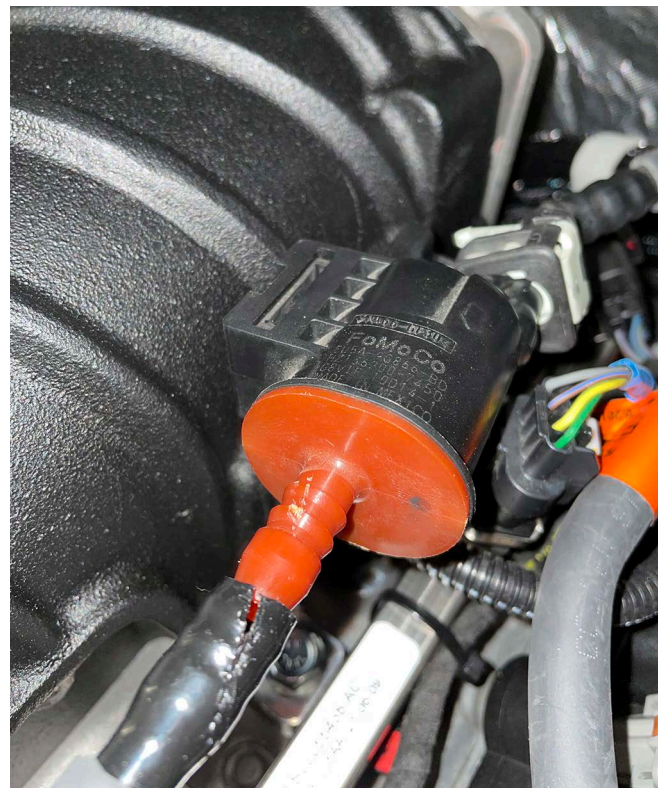

FRONT COVER MODIFICATION

WARNING

Wear safe eye protection when grinding to prevent serious personal injury.

1. Move the auxiliary water/heater pump out of the way to access the front cover for modification.

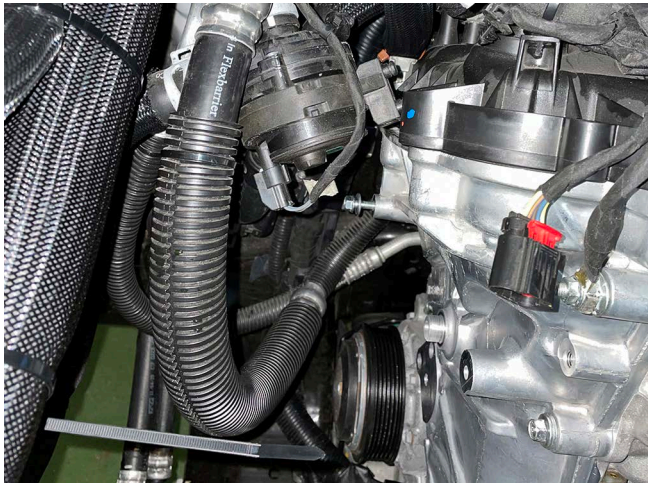

2. If not already done so, clean the engine surfaces with brake clean and dry with shop air.
3. Mask off the surrounding areas where the grinding will be performed to prevent debris and metal shavings from spreading through the engine compartment. Ensure all coolant ports and PCV openings have been taped to prevent debris entering the engine.

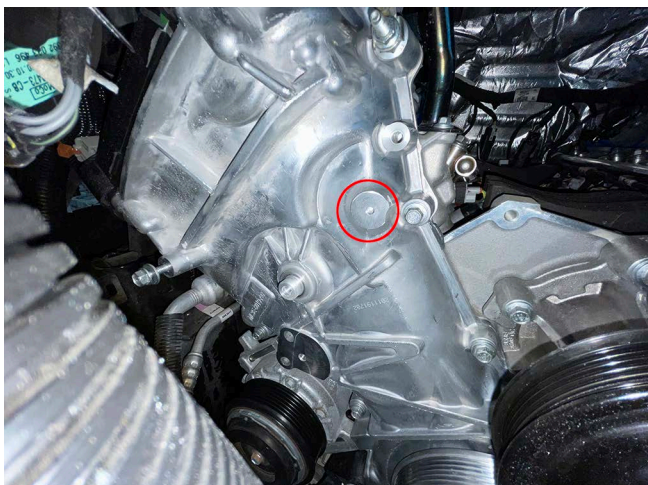

4. Locate the boss circled in red on the front cover. This boss needs to be reduced in height such that you cannot see any more threads in the tapped hole. Apply reference marks on the boss to guide this modification.

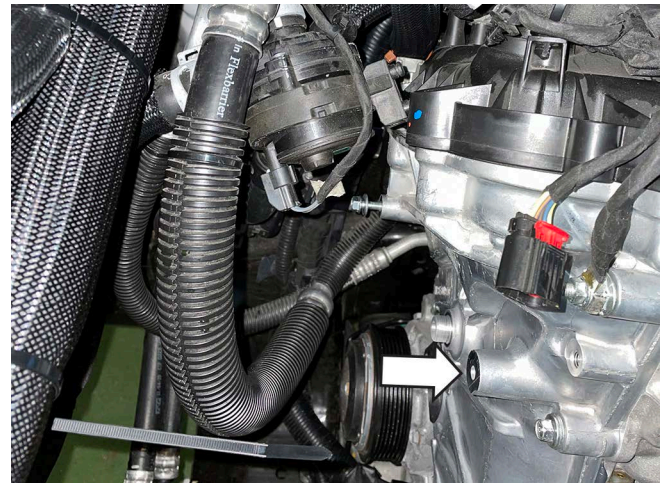

Before

5. Using a grinder or cut-off wheel, modify the front cover in the area shown. Check that the area where the boss was and confirm there are no threads visible.

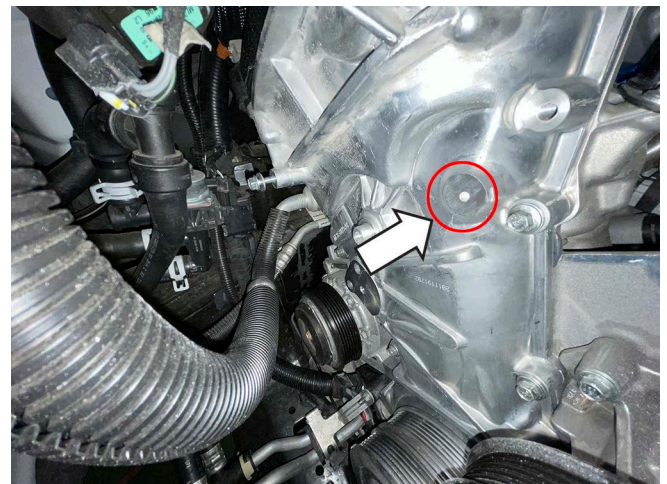

After

Ensure there are no threads visible in the tapped hole.

6. Vacuum out the metal shavings and clean the area.

INTERCOOLER PUMP HARNESS PROCEDURE

1. Obtain the intercooler pump electrical harness (PT00042003). Route and tuck the harness underneath the air deflector to the pump on the driver side frame rail location.



2. Install the M6 J-clip (N623332-S439) over the hole in the rear corner of the battery box as shown.

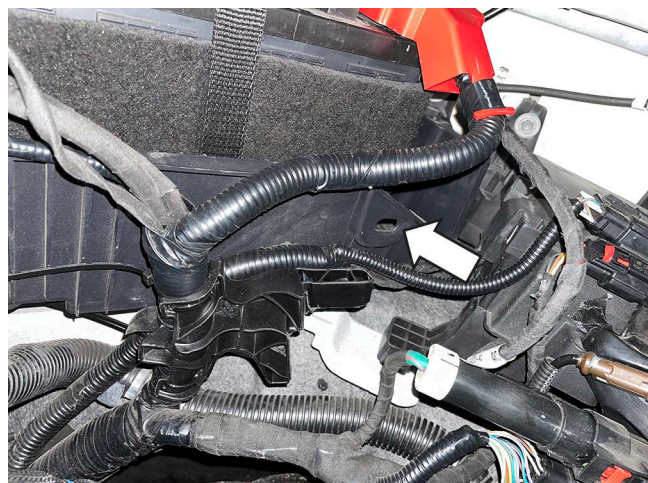

3. Install the relay and fuse from the intercooler pump wiring harness (PT00042003) onto the J-clip. Use one (1) M6 x 1.0 x 20 bolt (W500214-S437) to secure the relay and fuse to the J-clip. Torque the bolt to 5 Nm.



4. Route the black ground wire from the I/C pump harness along the chassis and up the radiator support to the passenger side of the vehicle to the factory ground on the body by the hood support strut. Torque to 10 Nm.



5. Route the red wire (part of the intercooler pump wiring harness installed above) to the positive terminal of the battery cable. Remove the nut from the positive terminal and install the red wire eyelet. Reinstall the nut onto the terminal and torque to 10 Nm.

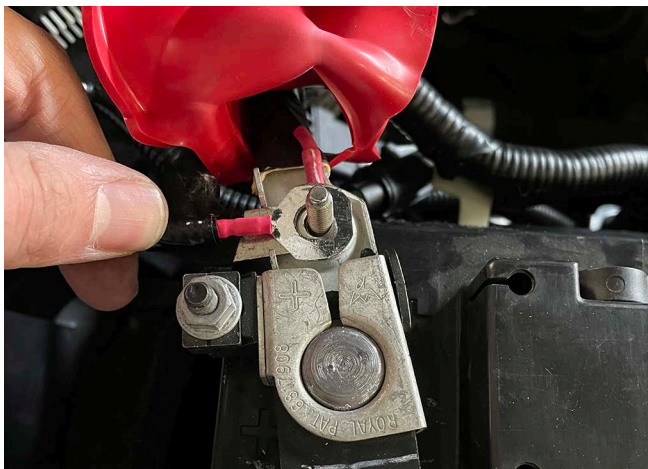

6. Locate the cylinder 1 deactivation solenoid on the RH cam cover and disconnect the electrical connector. Connect the intercooler pump trigger to the cylinder 1 cylinder deactivation solenoid.



7. Plug cylinder 1 cylinder deactivation solenoid plug (plug taped to harness PT00042003).

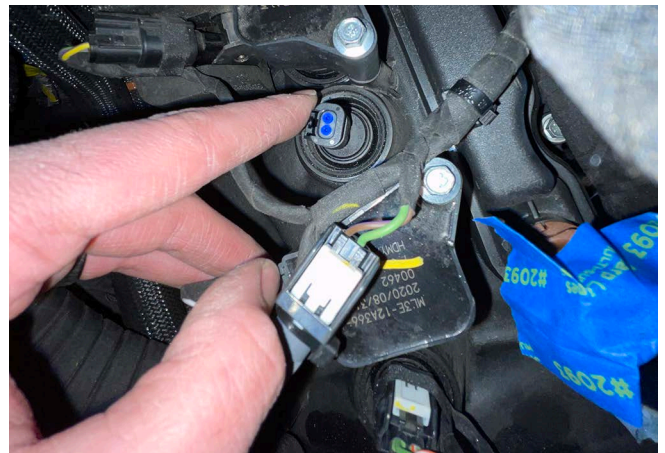

HARNES IAT-1 PROCEDURE

1. Obtain the IAT 1 harness (PT00040445 found in 1121-HWKE). Route the harness from the PCM connectors along side the battery, through the cutout for the AC line, and around the front of the vehicle to the driver side.

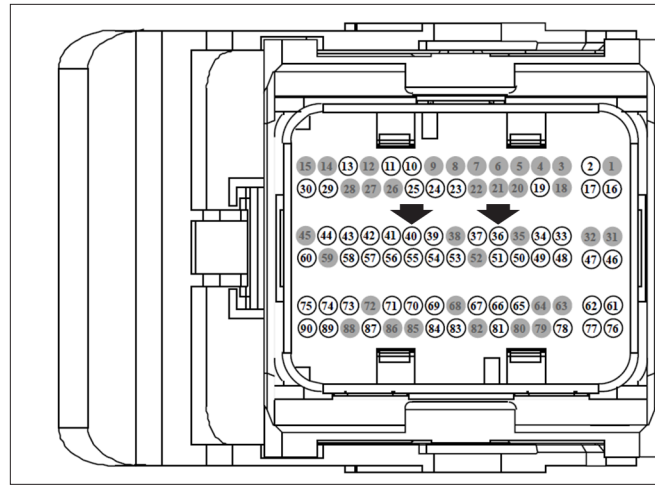

Pin	Circuit	ROUSH Wire Color
36	VE750 (GN-BU)	WH
37		
38	*	
39		
40	RE230 (WH-OG)	WH-OG

4. Install the IAT-1 harness (PT00040445) into the vehicle connection in location 36 (white) and 40 (white/orange). Ensure wire terminals are oriented properly or it will not install into vehicle connector.

2. Disconnect the vehicle PCM connector and take off the backing to expose the PCM wires. The connectors are labeled.

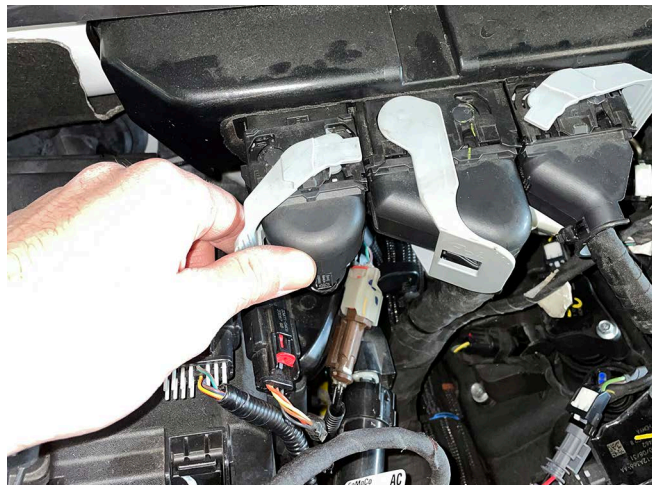

5. Cut the terminals off the two (2) wires removed from the PCM. Crimp on the supplied terminals (taped onto harness PT00040445).

3. With a small wire extraction tool, remove the pins in locations 36 and 40. Pin 36 is GN-BU. Pin 40 is WH-OG.



6. Insert the two (2) PCM wires into the supplied connector on the IAT harness. The green-blue wire gets installed into pin 4. The white-orange wire gets installed into pin 3.

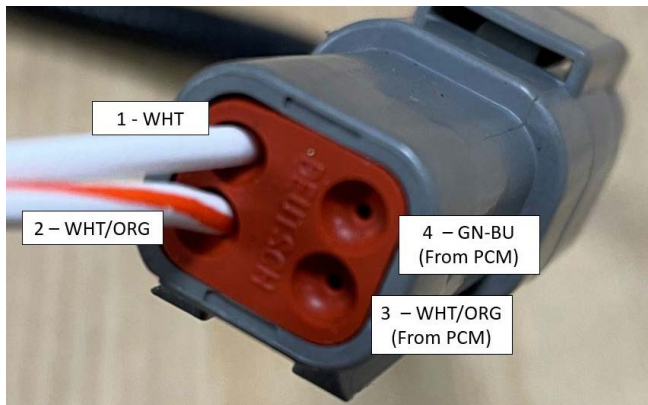

7. Put the backing on the PCM connector, zip tie the wires on the connector and re-connect the vehicle connector. Secure the IAT-1 connector as shown.

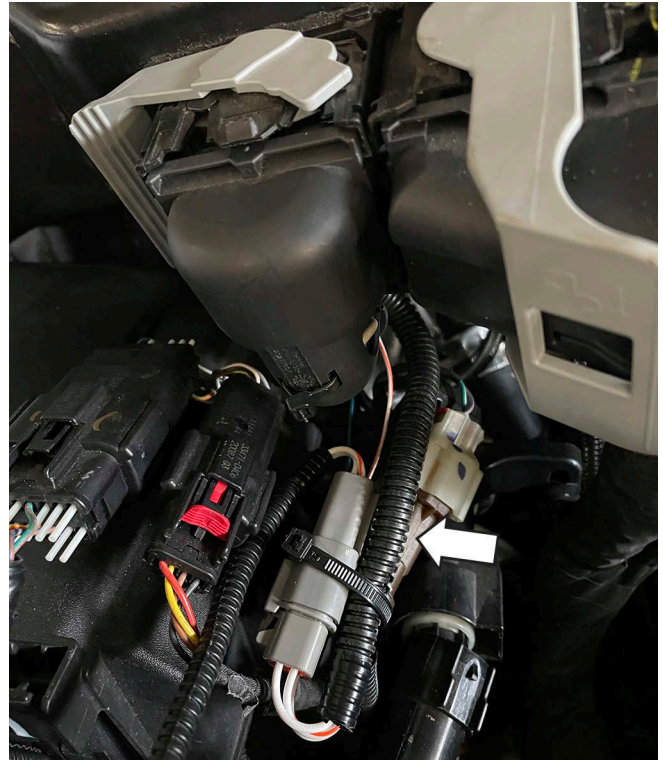

8. Route the IAT-1 harness by the battery box and around the front of the air deflector as pictured.





9. The other connector will connect to the air temp sensor in the clean air tube when installed. Zip tie the harness so it is out of the way. Cut the tails off the zip ties.



2. Plug the connector into the stock MAP sensor connector.



MAP/MCT SENSOR HARNESS

1. Route the MAP/MCT harness (PT00042001 found in 1121-HWKE) behind the cylinder head.

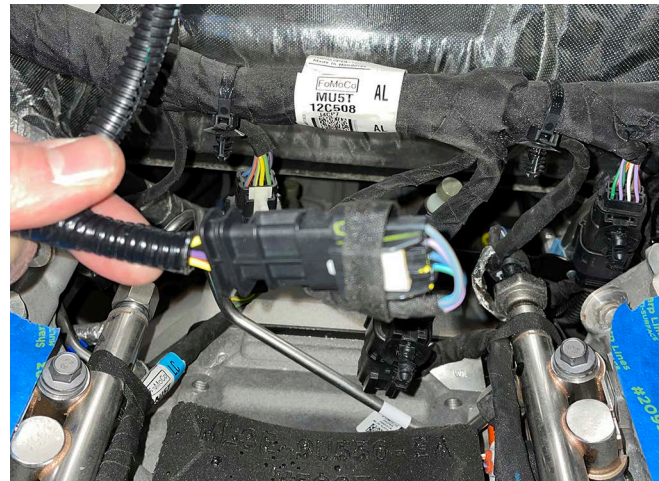

3. Zip tie the harness to the engine harness all around the cylinder head as shown.
4. The new MAP sensor will be connected later.





RH cylinder head

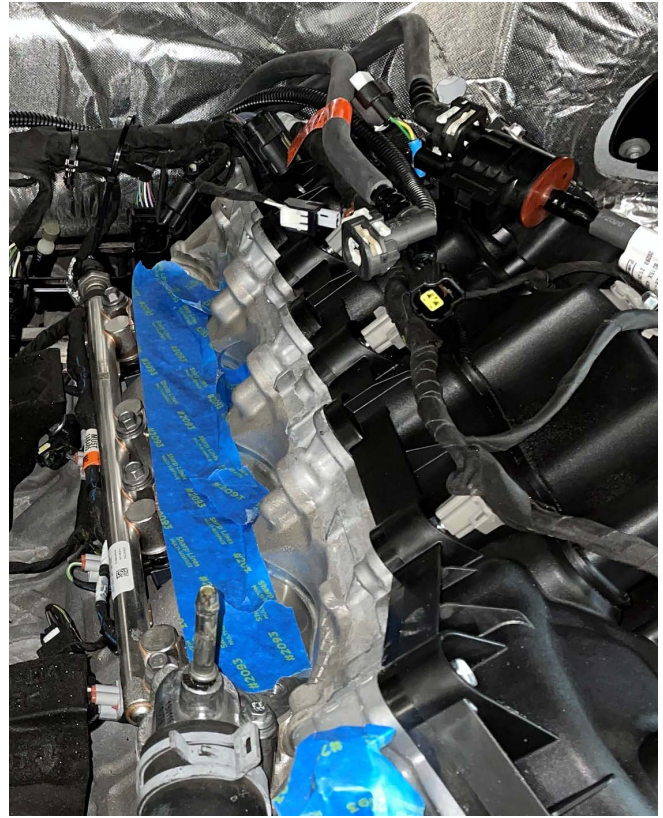

LH cylinder head



FUEL PUMP VOLTAGE REGULATOR (FPVR)

1. Remove the jack stand from behind the rear passenger seat to access the rear liner. Remove the push pin with a trim tool to pull the rear seat liner back.



2. Locate FPVR (1315-FPVRKIT found in hardware kit 1121-HWKE) and double-sided body tape (FS00052419 found in hardware kit 1121-HWKE). Place half of the double-sided body tape on either side of the FPVR mounting feet.
NOTE: Clean mounting feet with alcohol prior to placing the tape.



3. Locate the area behind the rear seat liner as pictured and mount the FPVR. Press firmly on the mounting feet to adhere the tape to the rear panel.
NOTE: Clean the mounting area with alcohol prior to adhering the tape.



4. Locate the grounding wire on the FPVR (black-colored ring terminal) and locate the grounding location on the rear panel. Fasten the ring terminal and torque to 10 Nm.



5. Locate the fuel pump module on the frame rail underneath the vehicle. Plug in the connector from the FPVR to the fuel pump module as pictured and the second connector to the Ford fuel pump module connector. Route the rest of the harness on top of the frame rail and use edge biter (156-00865 found in hardware kit 1121-HWKE) to retain connector in the location shown.

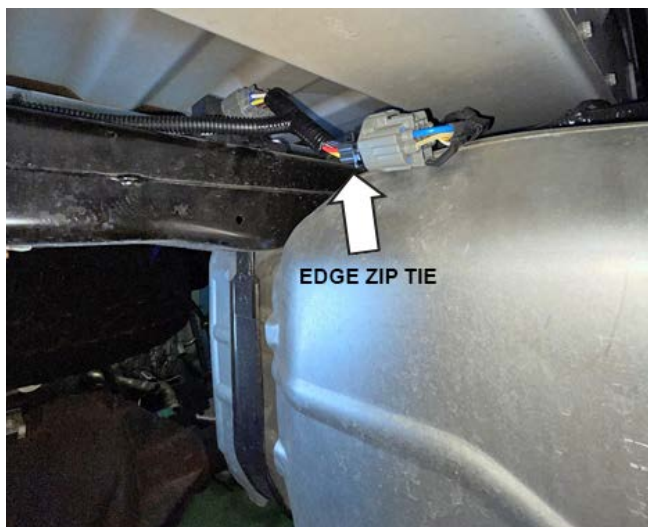

6. Locate the FPVR Harness (PT000042352 found in hardware kit 1121-HWKE). Remove the bag with the terminal taped to the harness. Feed the end with the three (3) terminals through the rear cab vent, from inside to outside, located in the rear corner of the cab.

NOTE: Apply masking tape around the pins to keep them from getting damaged.



7. Plug the terminal that is pinned on the FPVR Harness (PT00042352) into the FPVR harness connector on the module.



8. Locate the connector in the bag that was taped to harness (PT00042352). Pin the connector as pictured, outside the vehicle. Connect the pinned connector into the section of harness going to the fuel pump module already installed.

NOTE: The wire color locations should match.



9. Secure the harness to the top of the frame rail with an edge zip tie in the three (3) locations shown (156-00865 found in hardware kit 1121-HWKE).

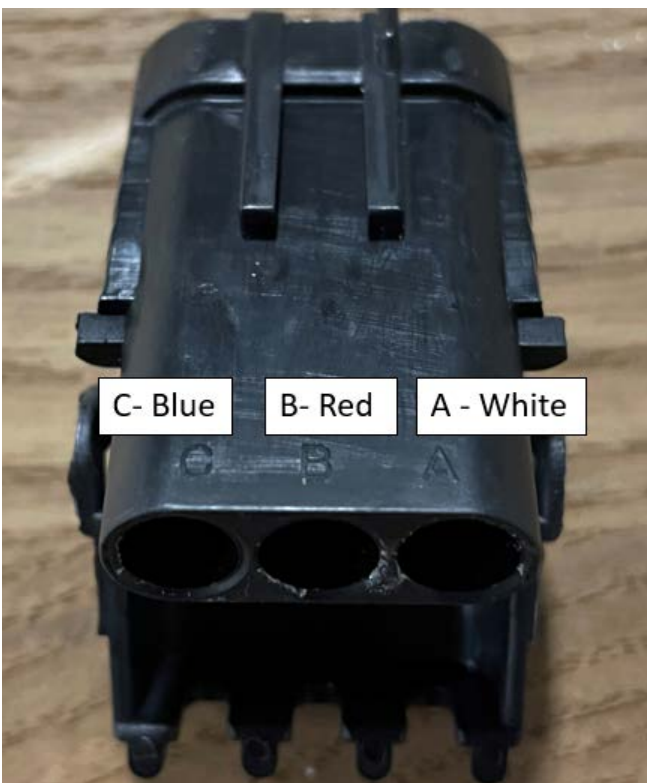



10. Pull any slack in the wire harness back through the vent and secure the wire harness.



11. Re-install the rear liner. Re-install the jack.



KNOCK SENSOR ORIENTATION ADJUSTMENT

The knock sensors must be reoriented and the harnesses rewrapped to accommodate the new fuel charging assembly. It will be necessary to split the four (4) sensor wires further up the harness in order to gain the necessary slack for proper sensor positioning.

1. Remove the foam isolators from the valley. They will not be reused.

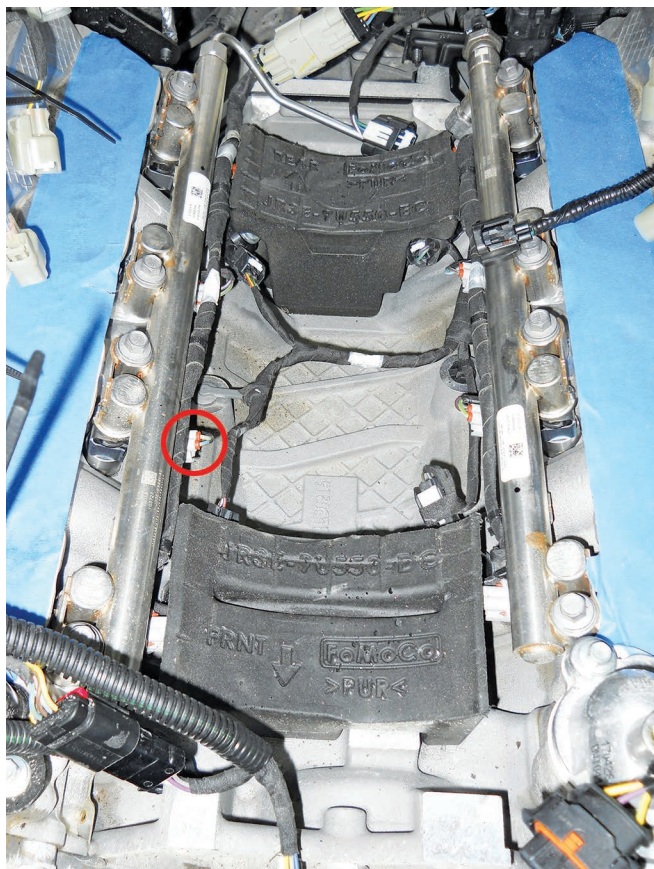

2. Remove the two (2) wiring retaining push clips on the harness in the valley and cut the clips off the harness.

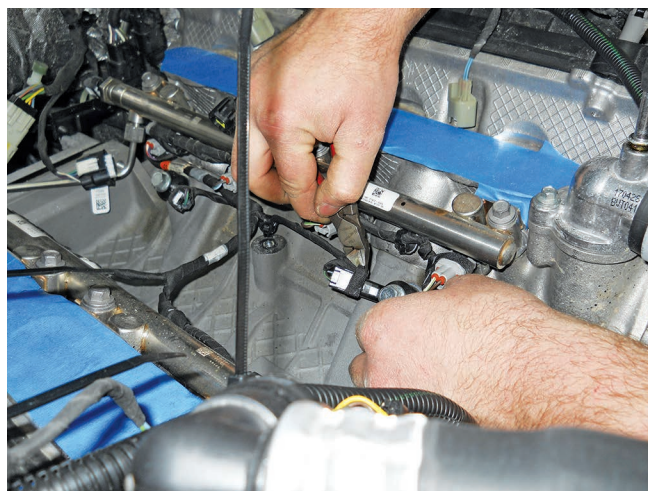

3. Cut back the tape loom in the knock sensor harness to give the harness more slack.

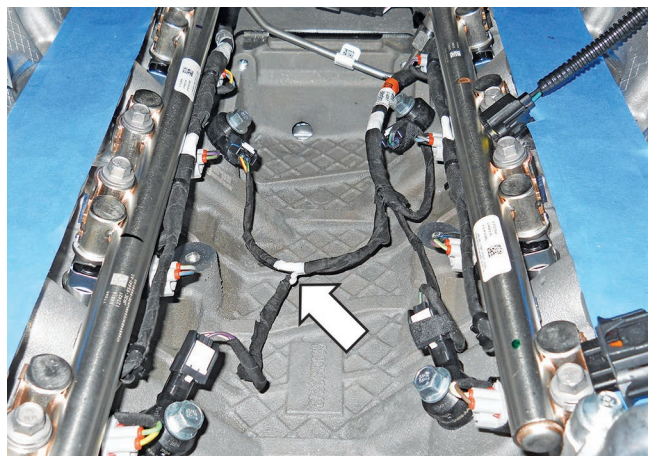

4. Remove the four (4) bolts which retain the knock sensors to the engine block (13 mm socket). Discard the bolts.

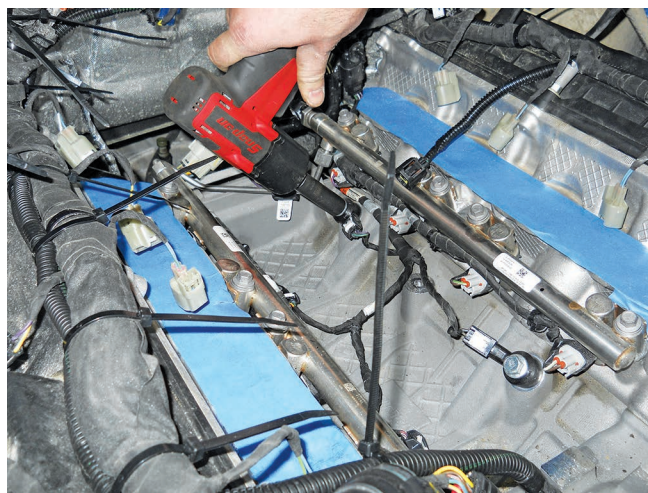

5. Temporarily fit the sensors as follows to determine where to rewrap the wires. Install and rotate the RH and LH knock sensors as far as possible to the inside of the valley of the block. Check that the sensors lay low on the engine valley so they will not interfere with the fuel charging assembly once it is installed.



6. Reinstall the convolute and rewrap the wires with electrical tape as required.
7. Install the knock sensors in position. (Electrical connectors pointed towards the center.) Apply Loctite 242 to the threads of the new bolts. Install the new bolts (92095A292, found in 1121-HWKB) and torque them to 16.2-23.8 Nm (5 mm Hex socket).

CHANGING THE FACTORY SPARK PLUGS

1. Disconnect the electrical connectors for each ignition coil.



2. Remove the fasteners holding the coil-on plug assemblies in place (8 mm socket). Save the fasteners for re-use.



3. Remove the coil-on plug assemblies and label them so they can be reinstalled in their original positions. A slight twisting motion will break the seal and ease removal.

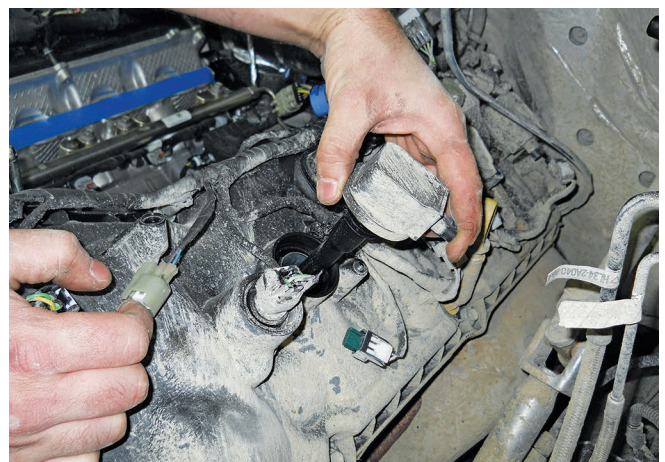

4. Use a 14 mm spark plug socket and 8" extension to remove the eight (8) factory spark plugs. Discard the spark plugs.

NOTE: Use a 6" extension with a 2" wobble to reach the rear RH plug.

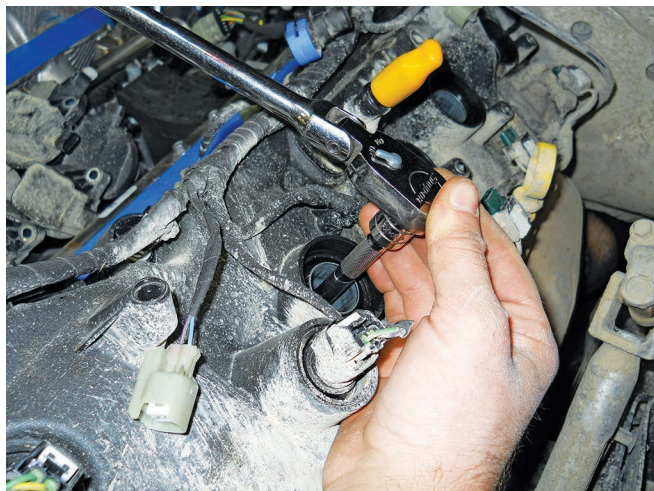

5. Unpack the eight (8) provided spark plugs [FS00056643 (M-12405-50VDE, HYFS-092YPT), found in 1121-KIT2] which are pre-gapped to 0.028-0.031" (0.7-0.8 mm). Use a 0.031" feeler gauge to ensure the gap is intact and none are damaged.



6. Apply Loctite silver grade anti-seize to the plug threads.



7. Install the new spark plugs using a 14 mm spark plug socket and 8" extension. Torque to 14 Nm.
8. Apply a small amount of dielectric grease to the inside of the coil-on plug boots before attaching to the spark plugs. Install the ignition coil-on plugs in their original position. Install the coil-on plug bolts and torque to 6 Nm.
9. Connect the electrical connectors for each ignition coil in eight (8) places.
10. Locate two (2) spark plug warning labels (PT00045644, found in 1121-HWKF). Place 1 label on cylinder 1 and cylinder 5 coils (front coil of RH and LH side).



LTR MODIFICATION

1. Remove and discard the active grill shutter blades.
NOTE: To ease modification, the active grill shutter can be removed from the grill but it is not required.

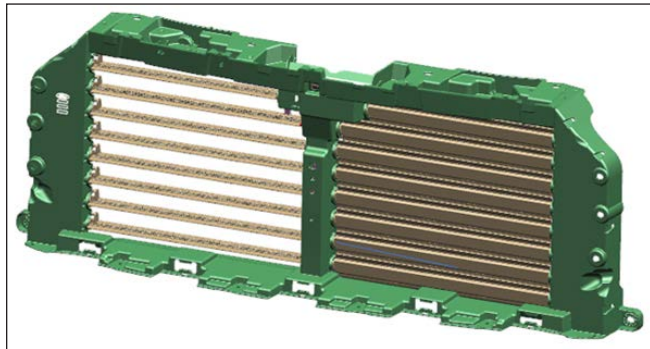

Prior to Modification

2. After the shutter blades have been removed, remove the center support as pictured below.

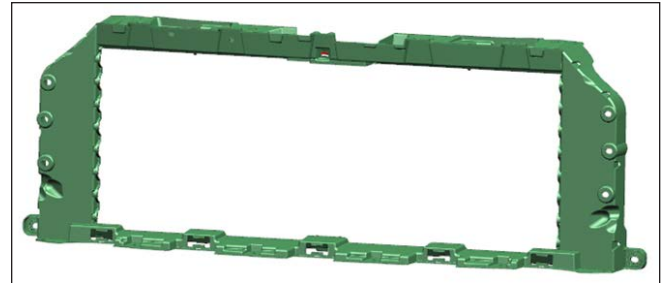

After Center Support Modification



Active Grill Shutter Motor - Discard

3. Locate drill templates 5, 6, and 7, located in Section F, Templates. Mark the location for the 9/16" drilled holes in the three (3) specified locations for the LTR bottom mounting grommet. Drill three (3) 9/16" holes.
4. Locate drill templates 1, 2, 3, and 4, located in Section F, Templates. Mark four (4) 3/8" holes for the top mounting fasteners with the supplied templates. Drill four (4) 3/8" holes.

NOTE: Print out drill templates to locate holes. Drill templates are located in Section F. Be sure to print them 1:1 (100%).

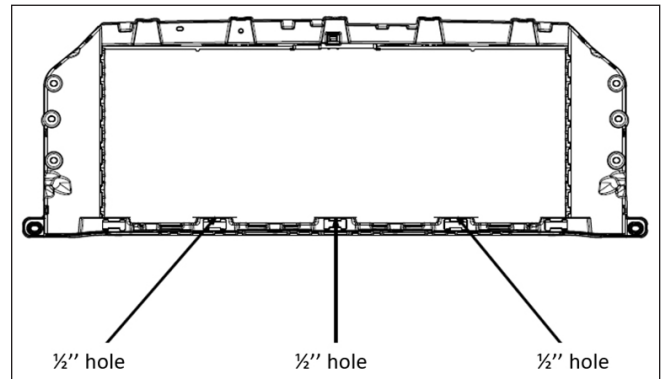

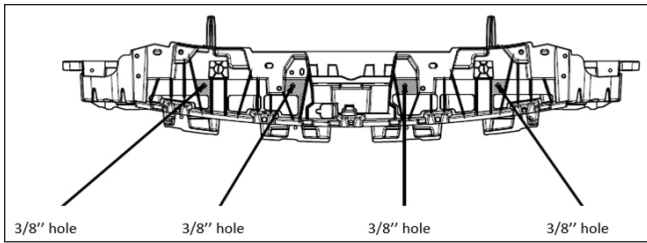

5. Locate the previously removed upper radiator close out, and cut out the area to allow the LTR hoses to pass through the close out. The cut out area is 2-3/16" x 2-9/16" (56 mm x 80 mm).



6. Locate the LTR outlet hose and the intercooler pump-to-LTR hose (PT00040588 and PT00040441 found in 1121-KIT3). Reinstall the close out and test fit the modification to ensure there are no sharp edges that can damage the hoses.

SECTION C – SUBASSEMBLY AIR BOX ASSEMBLY

1. With the stock dirty air duct and air box tray assembly removed from the vehicle, remove the bolt securing the dirty air duct in place on the air box tray. Separate the tube from the air box; the air box tray will not be reused. Keep the bolt for reuse.

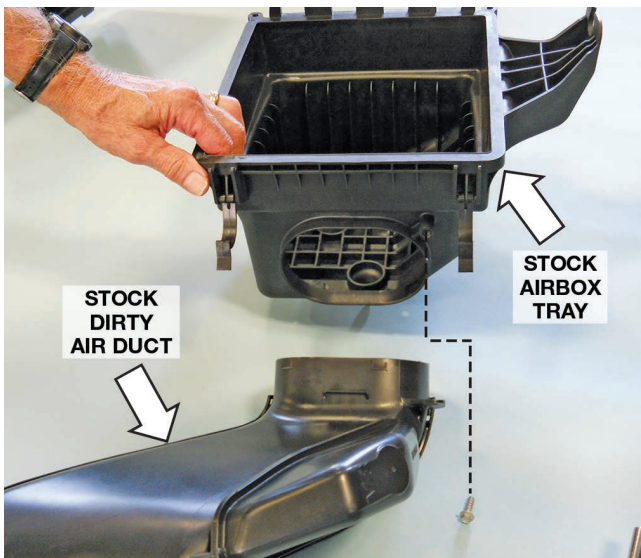

2. Remove the grommet and sleeve from the factory air box and save for installation.



3. Transfer and assemble the stock dirty air duct to the new airbox tray (1115-9A612). Install the factory bolt to secure the duct in place. Torque the bolt to 3 Nm.

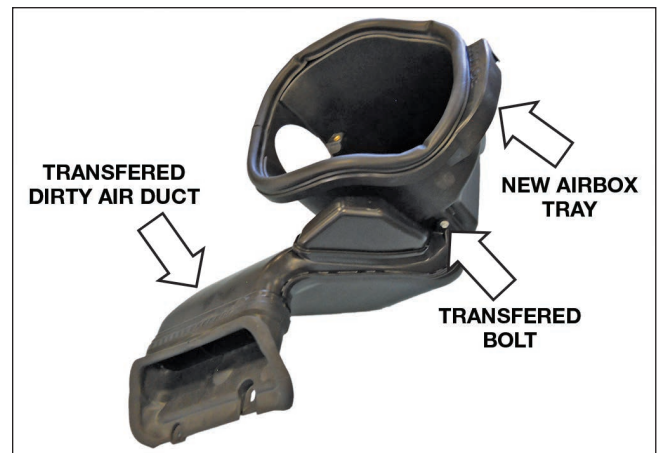

4. Install the air filter (131550-9601R) on the MAF tube (1115TT-12B579) and secure it with the supplied clamp. Torque the clamp to 3 Nm.

5. Insert the MAF tube and filter into the airbox tray and secure in place with two (2) M8 x 1.25 x 25 bolts (W500224-S437, found in 1121-HWKA). Torque the bolts to 10 Nm.



CLEAN AIR TUBE ASSEMBLY

1. Install the new grommets (1150-58GRMT, found in 1121-HWKA) into two (2) ports on the clean air tube assembly (1118SC-9B660).

6. Install the air temp sensor (DS7A-12A697) into the MAF tube found in hardware kit 1121-HWKA.



2. Install the 1/4" SAE fitting (SP001048) and the 5/8" SAE fitting (1311-9N285) found in 1121-HWKA in the respective ports on the clean air tube, as shown. Install vacuum cap pn: 6448K98 on smaller port circled below.

7. Install the airbox cover (1118-9643HC) onto the box. Use the six (6) self-tapping screws (W506976-S437, found in 1121-HWKA) to fasten the lid to the box. Do not overtighten.

***Note* IF THE ROUSH AIRBOX LID DOES NOT HAVE A HYDROCARBON TRAP ON THE UNDERSIDE OF THE LID, REFER TO APPENDIX F AT THE END OF THIS DOCUMENT ON PAGE 85.**

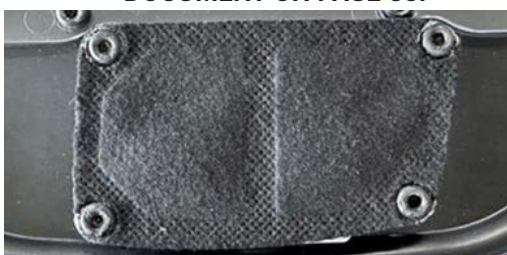

- Using the two (2) hose clamps (R07130015-13, found in 1121-HWKA), one (1) hose clamp (1368016100, found in 1121-HWKA), and one (1) clamp that was removed from the vehicle earlier, install the cuff, T-body-to-CAT (1118SC-9B662) and the coupler, MAF-to-CAT (1115SC-9B661) on the respective ends of the clean air tube (1115SC-9B660) as shown.



INTAKE MANIFOLD BUILD UP

- Remove the fuel charging assembly (PT00040739) from the packaging.
- Obtain the PCV purge hose and clamp (PT00042079 and 62003, found in 1121-KIT3).



- Attach the rubber hose from the PCV purge hose (PT00042079) to the bubbler fitting (3/8" barb) on the bottom of the fuel charging assembly and secure it with hose clamp (62003).

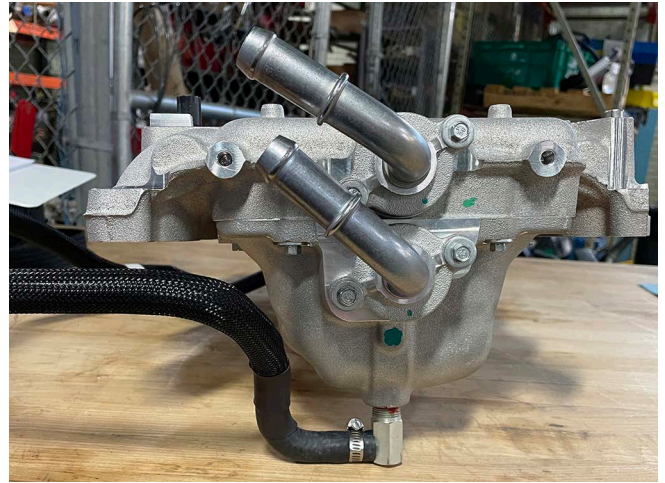

SUPERCHARGER BUILD UP

- Connect the supercharger boost bypass actuator hose (1318-9E498, found in 1121-HWKD) to the top port on the actuator and route to the small port on the supercharger (PT00040777).



- Install the O-ring/gasket (FS00056840, found in 1121-HWKB) into the groove on the supercharger.



3. Install the throttle body that was removed from the OE intake manifold onto the supercharger. Make sure the part orientation is correct with the electrical connection oriented towards the passenger side of the vehicle. Install the four (4) M6X1.0X48 mm bolts (removed earlier) to secure the throttle body to the supercharger. Torque to 10 Nm (8 mm socket).



4. Install the supercharger badge (PT00041667) onto the top of the supercharger.



FUEL RAIL ASSEMBLY

1. Carefully install the eight (8) take-off anti-rotation fuel injector clips onto the take-off injectors.



2. Apply a little engine oil or petroleum jelly to the injector O-rings and install the injectors into the new fuel rail (FS00055438, found in 1121-KIT2). Make sure the electrical connectors all face forward on the LH side and all face rearward on the RH side.

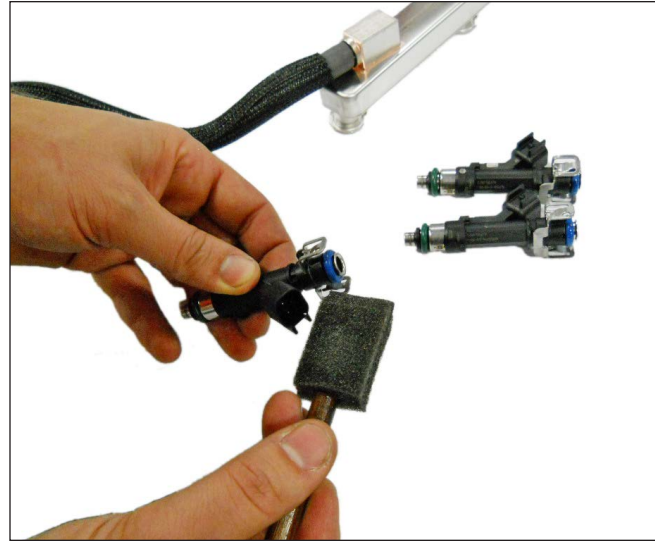

NOTE: Verify that the anti-rotation clips are properly aligned and fully engaged into the fuel rail injector cups.

3. Remove the pressure sensor from the stock fuel rail (24 mm socket).

NOTE: Ensure the fuel pressure sensor gasket has not been damaged during removal.

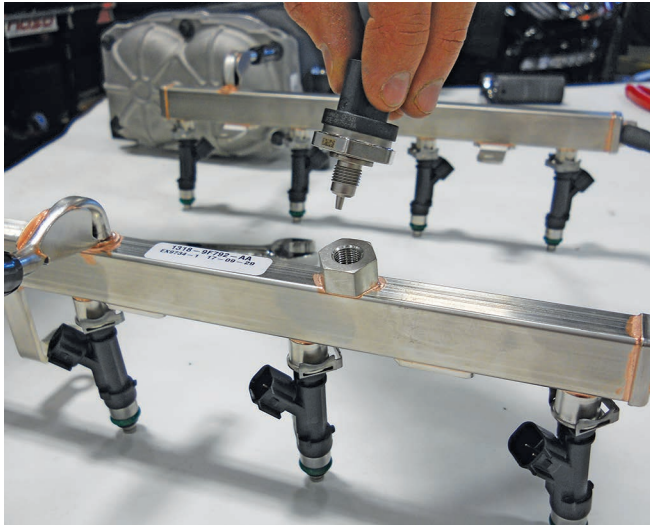

4. Install the pressure sensor in the new fuel rail. Hold the nut with a 19 mm wrench and use a 24 mm socket to tighten as follows.
Stage 1: Torque the nut to 53 lb-in (6 Nm).
Stage 2: Angle tighten the nut 25 degrees.



INTERCOOLER HARD LINE ASSEMBLY

(SKIP STEPS 1-3 IF DUAL ALTERNATOR VEHICLE)

1. Set the intercooler hard line assembly (PT00040591, found in 1121-KIT3) on a work bench.



2. Locate 3/4" jumper hose PT00040589 found in 1121-KIT3. Cut 12 mm off each end of one of the hoses.



3. Install the 3/4" jumper hoses (PT00040589, found in 1121-KIT3). Install one (1) constant tension clamp (CT19x12-BO, found in 1121-KIT3) over each hose. Install modified jumper hose onto the C.A.C. hard lines as specified by the locations below.



SECTION D – INSTALLATION

The following section will guide you through the final installation of the kit into the vehicle. If you need to stop during any part of the installation, make sure you cover any open ports in the cylinder heads or intake manifold to prevent foreign material from contaminating your engine.

HEATER TUBE INSTALL

1. **NOTE: IF VEHICLE IS EQUIPPED WITH PRO POWER ONBOARD (DUAL ALTERNATOR) SKIP TO APPENDIX D (Page 80) FOR WATER THERMOSTAT INSTALLTION PRIOR TO CONTINUING INSTALLATION**
2. Locate the heater tube PT00038883 , found in 1121-KIT3.. Insert it into the RH cylinder head and fasten it with the take out fastener. Torque to 10 Nm.

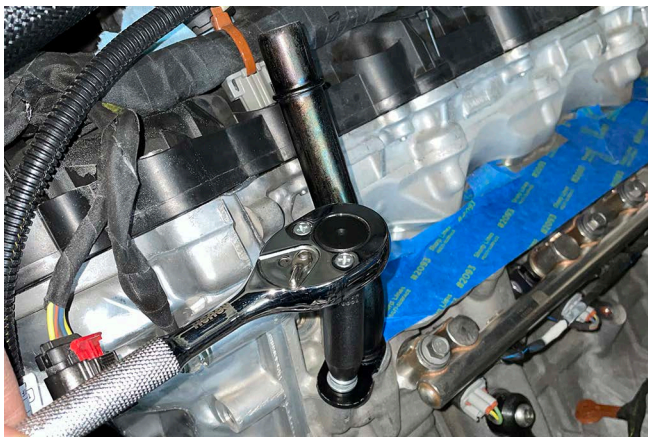

INTAKE MANIFOLD AND FUEL RAILS

1. Remove the tape from the cylinder heads and clean the cylinder head-to-intake manifold mating surfaces.
2. Install the fuel charging assembly (PT00040739) and check to make sure it is seated completely. Route the PCV hose under the DI fuel rail as the intake manifold is being slid into position.



3. Plug in the connector to the MAP sensor on the front of the intake manifold.

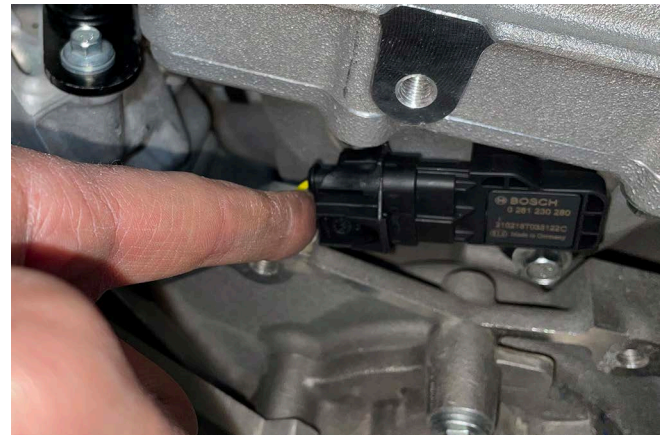

4. Loosely install the six (6) M6x1.0x40 mm bolts (R18020004, found in 1121-HWKB) in the intake manifold in the positions shown. Do not tighten yet.

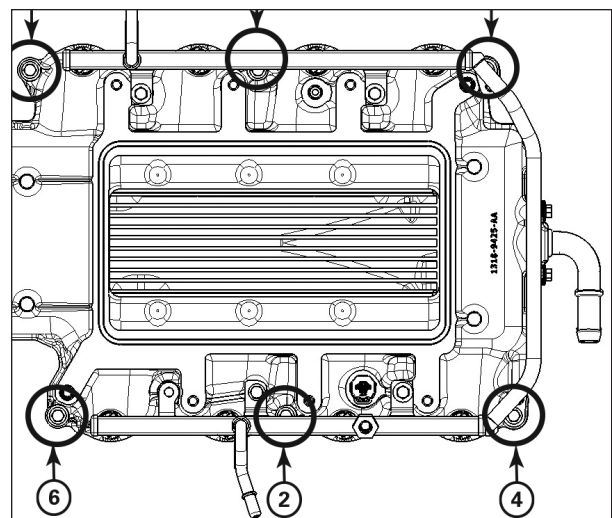

Intake manifold bolt tightening sequence

IMPORTANT: IF INSTALLING ON DUAL ALTERNATOR VEHICLES, SKIP STEPS 5,6,8 & 9 AND REFER TO APPENDIX E FOR INTERCOOLER LINES ON PAGE 83

5. Install two (2) clamps (CT19X12-BO, found in 1121-KIT3) on the tubes at the rear of the intake manifold. These clamps will secure the hoses from the intercooler hard line assembly when installed.



6. Temporarily place the intercooler hard line assembly (PT00040591) in position on the LH valve cover and connect the hoses to the tubes on the rear of the intake manifold. Test the fit to ensure the hoses are not kinked.
NOTE: The dipstick will need to be rotated 90 degrees to clear the intercooler hard lines.



7. Tighten the intake manifold bolts to the following specification.
Stage 1: Torque the bolts to 10 Nm.
Stage 2: Tighten the bolts an additional 45 degrees.

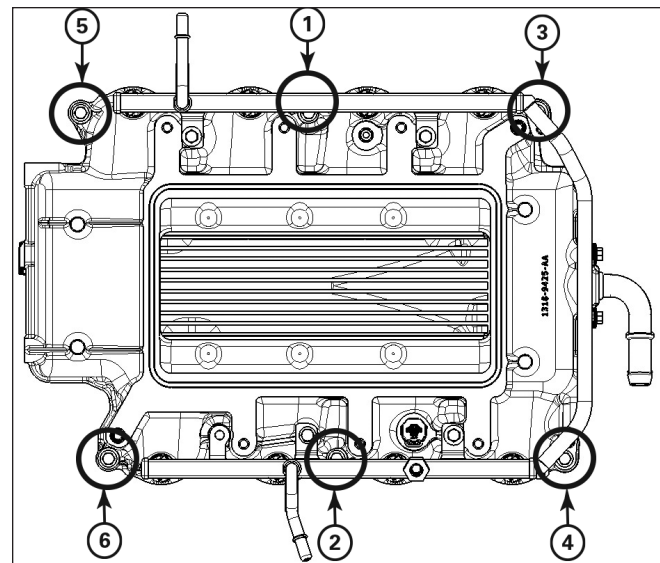

NOTE: Check that the PCV hose in back of the intake manifold is routed around the DI injector crossover tube and towards the LH cam cover.



8. Remove the first and last coil bolts (8mm socket) from the LH cam cover.

Place the intercooler hard line assembly in mounting position and reinstall the bolt. Torque to 6 Nm.



9. Secure the CAC hoses at the rear of the intake manifold with two (2) clamps (CT19X12-B0).

NOTE: Ensure the two CAC hose are not kinked. If kinked, cut additional length off the hose to get proper fit as pictured below.

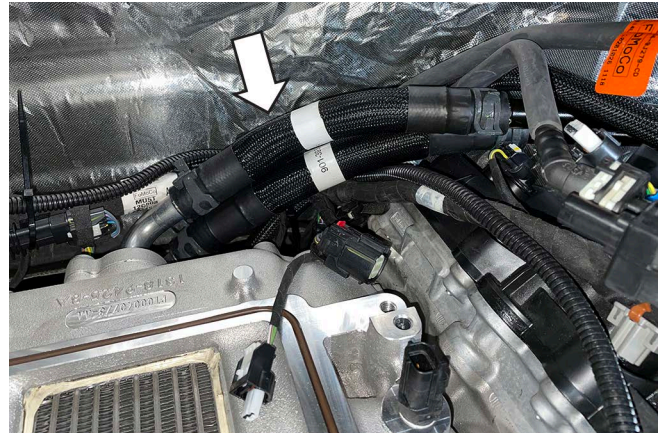

10. Connect the MCT sensor to the MCT harness (PT00042001).



11. Lubricate the lower fuel injector O-rings with petroleum jelly or engine oil. Install the fuel rail and injectors into the intake manifold. Be sure each injector is properly seated into the intake manifold. Install the three (3) previously removed fuel rail mounting bolts into three (3) of the four (4) fuel rail mounting locations (positions 1, 3 and 5 in the figure).

NOTE: Install the fuel injector harness to the fuel rail prior to installing the fuel rail.

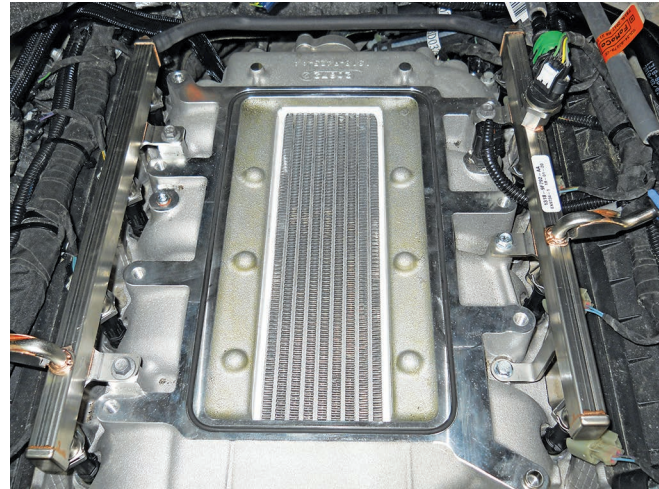
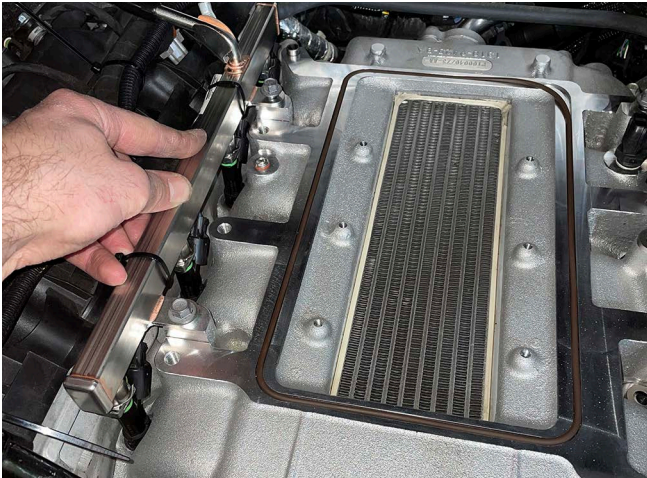

12. Install the M6x1.0x20 fuel rail-to-intake manifold bolt (BM6X20HF-S437) (short) at position 2 and M6x1.0x45 fuel rail-to-cylinder head bolt (161817) (long) at position 4. Bolts are found in 1121-HWKB. Tighten the bolts in two stages in the sequence shown.
Stage 1: Torque the bolts to 10 Nm.
Stage 2: Tighten bolts 1, 3 and 5 an additional 45 degrees. Do not angle tighten bolts 2 and 4.

13. Confirm all eight (8) fuel injector connectors are connected.

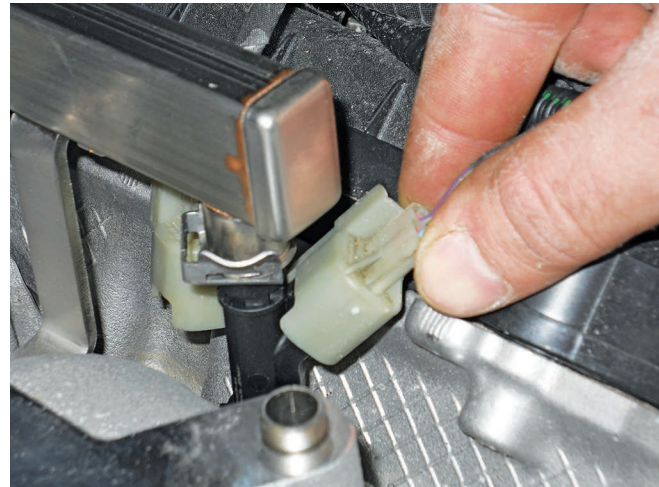

14. Plug in the connector to the fuel pressure sensor on the fuel rail.

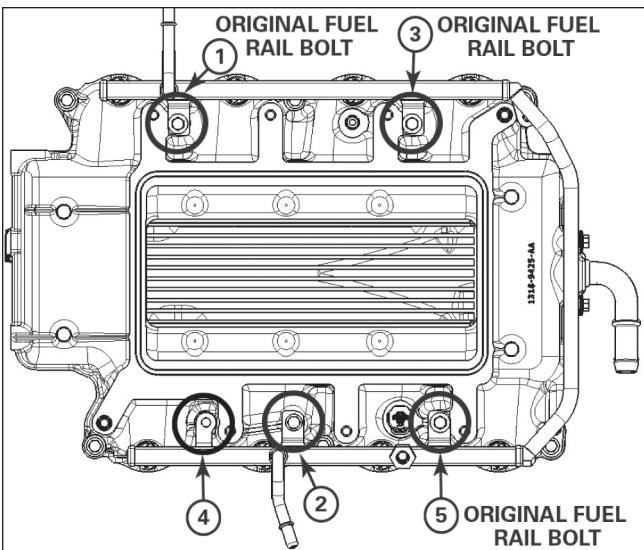

Fuel rail bolt tightening sequence



UPPER FEAD BRACKET

1. Place the upper FEAD bracket (1318-8B653U,

found in 1318-KIT3) in position on the FEAD.

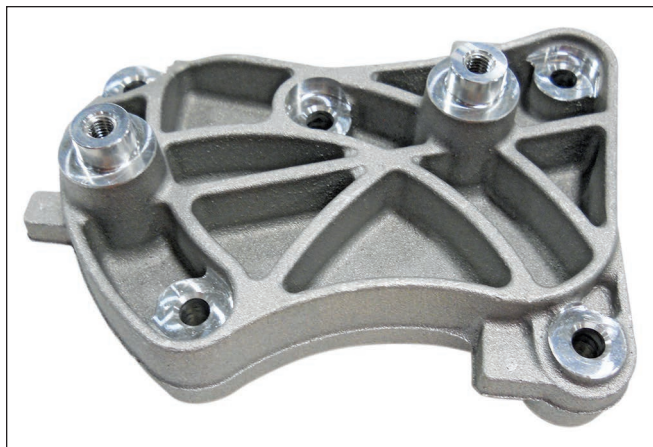

needed.



2. Install the four (4) upper FEAD bracket-to-engine bolts (M8x1.25x60) (11116346). Install one (1) upper FEAD-to-intake (M8x50) bolt (W500313-S437), in the upper left corner. Torque to 25 Nm. All the bolts in this step are found in 1121-HWKC.



3. Install the black 76 mm grooved idler pulley (FS00057912, found in 1121-KIT3) on the upper right of the FEAD bracket with one (1) idler bolt (M8 X 1.25 X 22 FS00058042, found in 1121-HWKC). Torque to 25 Nm.
4. Install the silver 70 mm smooth idler pulley (34-0284, found in 1121-KIT3) on the lower left of the FEAD bracket with one (1) idler bolt (M8 X 1.25 X 22 FS00058042, found in 1121-HWKC). Install FEAD pulley shield (PT00040547, found in 1121-HWKC), M8 X 1.25 X 22 bolt, and fender washer (9110A160, found in 1121-HWKC) on silver 70 mm smooth idler. Torque to 25 Nm.
NOTE: Install M8 x 24 mm fender washer onto the 70 mm pulley to provide clearance to pulley if
5. Locate the idler bracket PT00040860, one (1) W500313 (M8 X1.25 X50) bolt, and two (2) (M8 X 1.25 X 60) bolts. Remove the three (3) fasteners located on the front cover and the water pump. Install the bracket and torque to 25 Nm.

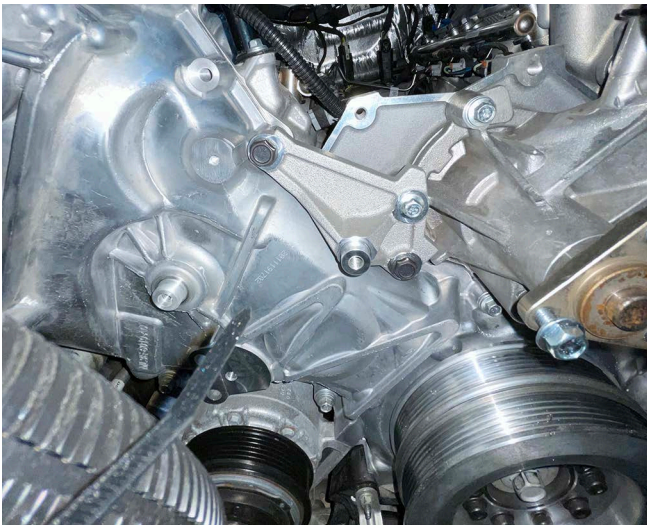
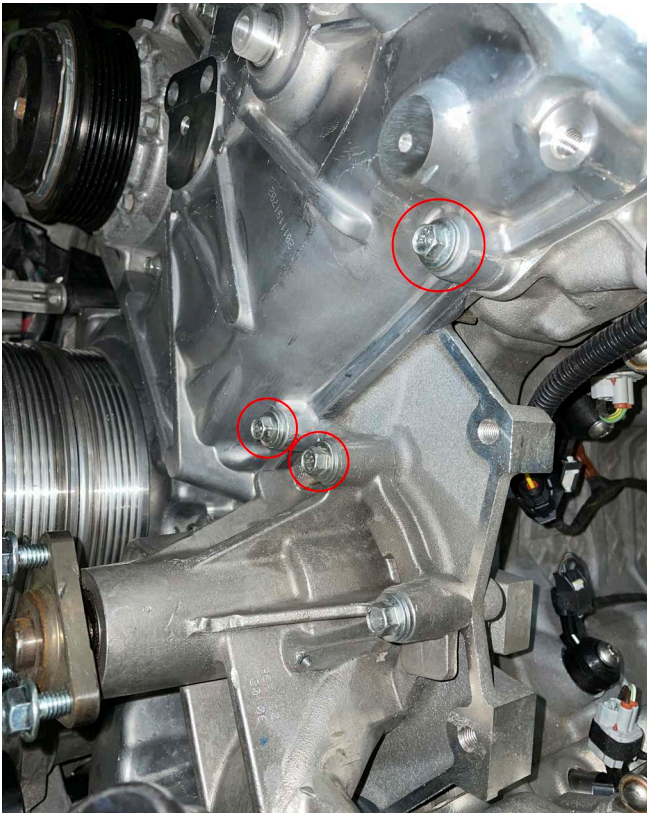

NOTE: Install M8 x 24 mm fender washer onto the 70 mm pulley to provide clearance to pulley if needed.

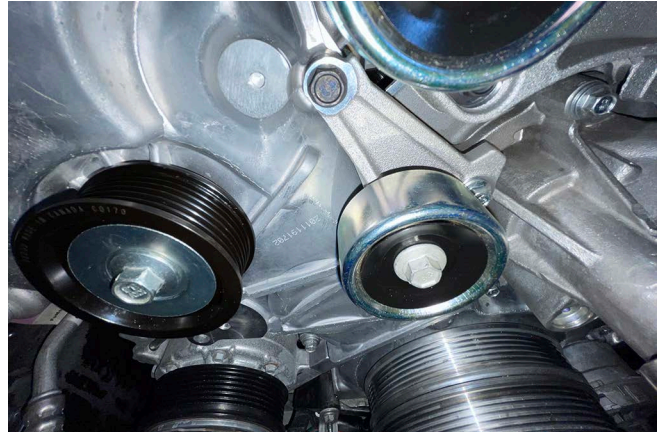

SUPERCHARGER

NOTE: Make sure the O-ring on the upper intake manifold is in position and has not rolled out of the groove.

6. Install the silver 70 mm smooth idler pulley (34-0284, found in 1121-KIT3) on the idler bracket with one (1) idler bolt M8 X 1.25 X 22, one (1) FEAD pulley shield (PT00040547, found in 1121-HWKC), and one (1) M8 X 24 mm fender washer (9110A160, found in 1121-HWKC) on the 70 mm smooth idler pulley.
 7. Install the 76 mm grooved pulley (FS00057912, found in 1121-KIT3) onto the front cover location with the fastener removed from earlier. Torque both to 25 Nm.
1. Partially set the supercharger in place over the intake manifold.



2. Connect the stock throttle body harness to the throttle body.

NOTE: The harness tape may need to be cut back to ensure connector can plug in without tension on the wires.

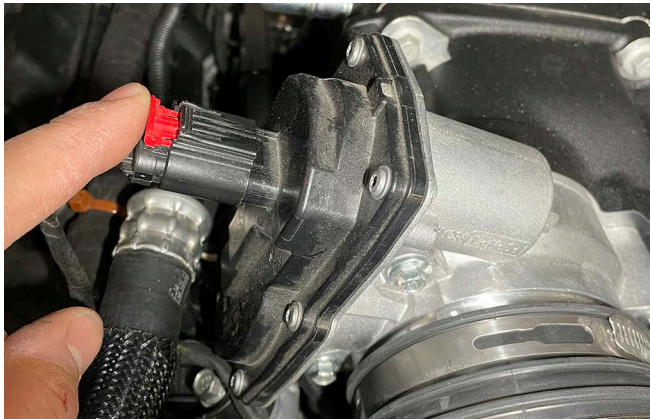

3. Carefully install and seat the supercharger assembly (PT00040777) in place on the intake manifold. Ensure that the supercharger is fully seated on the intake mounting dowels.



4. Install the provided eight (8) M8 X 1.25 x 40 fasteners (161826, found in 1121-HWKB) into the mounting holes. Torque the fasteners to 25 Nm in the sequence shown (13 mm socket).

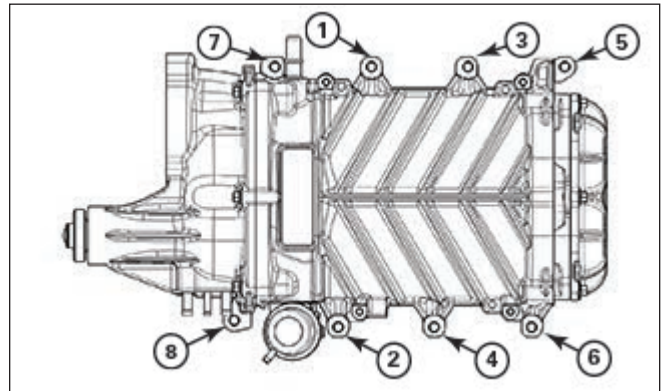

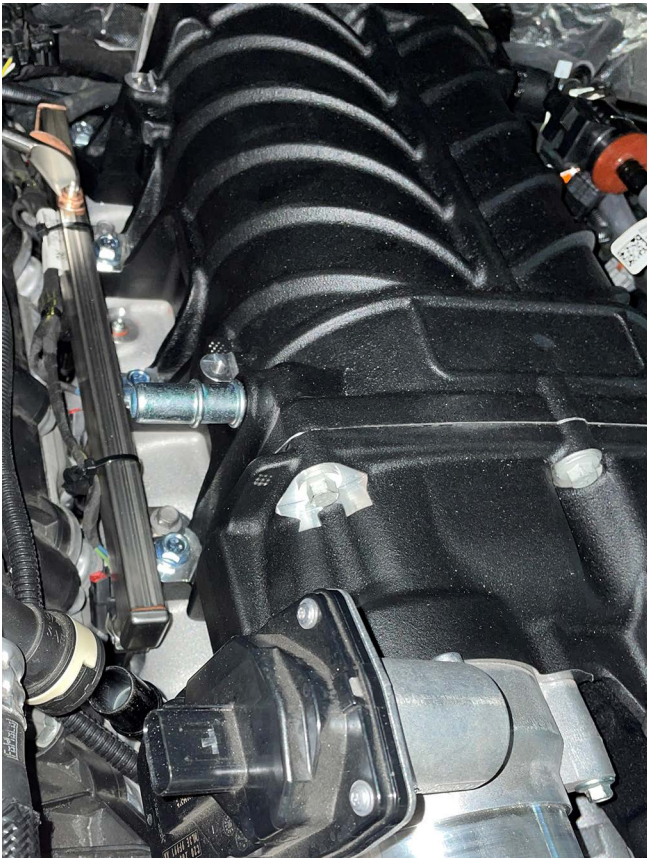

Supercharger bolt tightening sequence

5. Connect the bubbler hose (PT00042079) to the supercharger and secure it with a clamp (62003, found in 1121-HWKD).

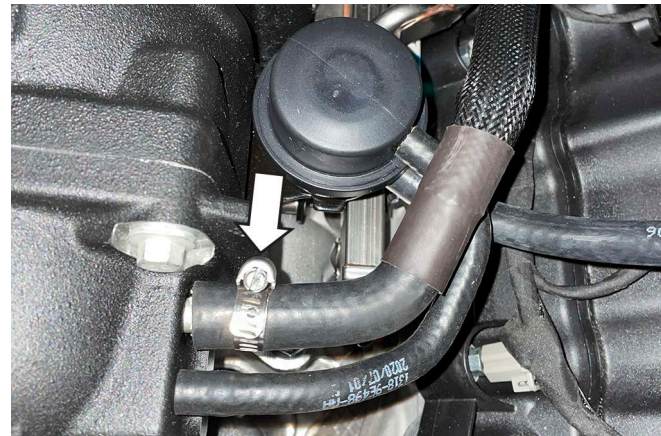

6. Install the hose (PT00040973, found in 1121-HWKD) between the supercharger and EECPV. Secure it with two (2) clamps (62003, found in 1121-HWKD).

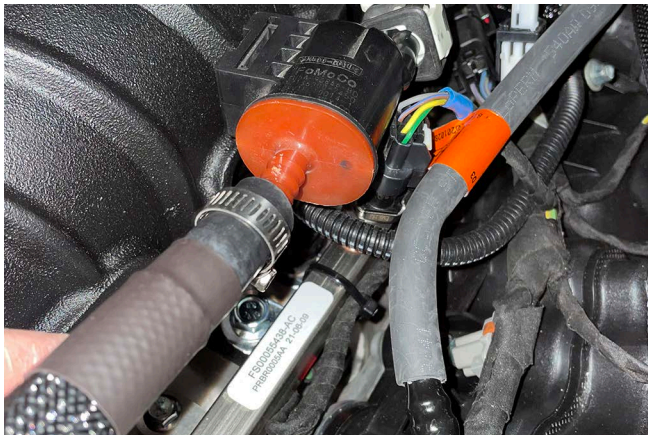

7. Install the connector to the EECPV. Install the purge line (with green connector) to the EECPV. Zip tie the EECPV to the supercharger through the threaded hole.

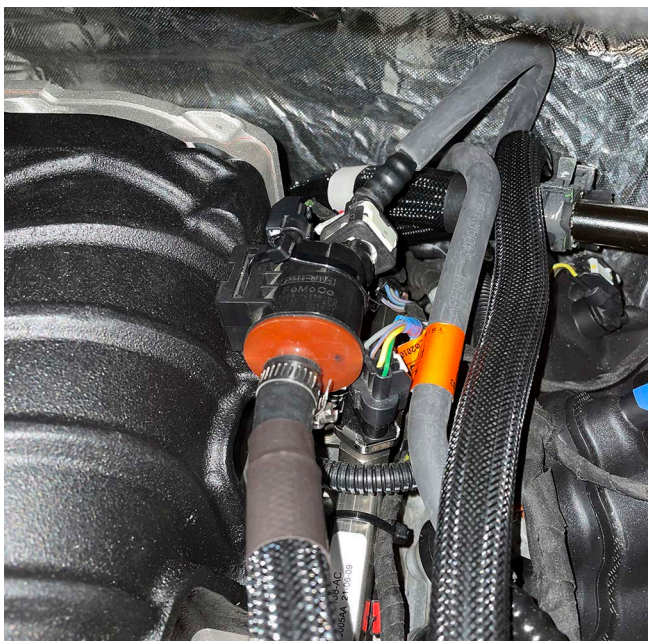

8. Install the fuel inlet line to the tube on the LH fuel

rail. Lock the connector.



9. Locate 1320-15799SLV-AB found in 1121-HWKB, install over fuel line to prevent chaffing.

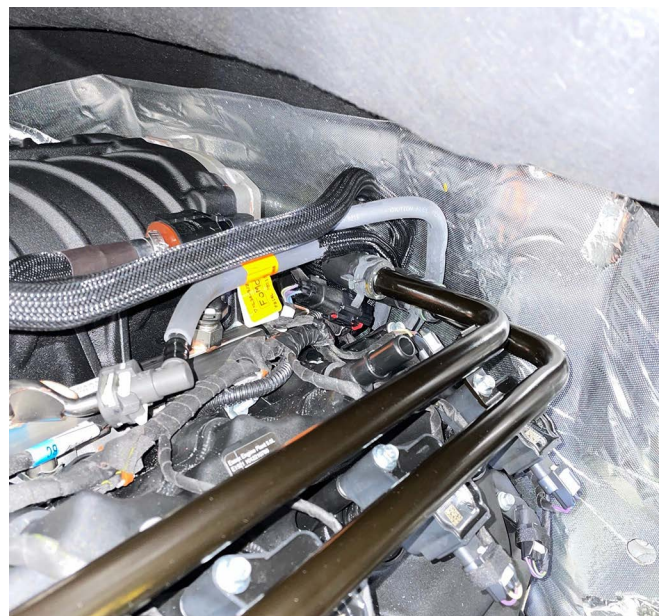

10. Connect the high pressure fuel supply line to the RH fuel rail and lock it into position.

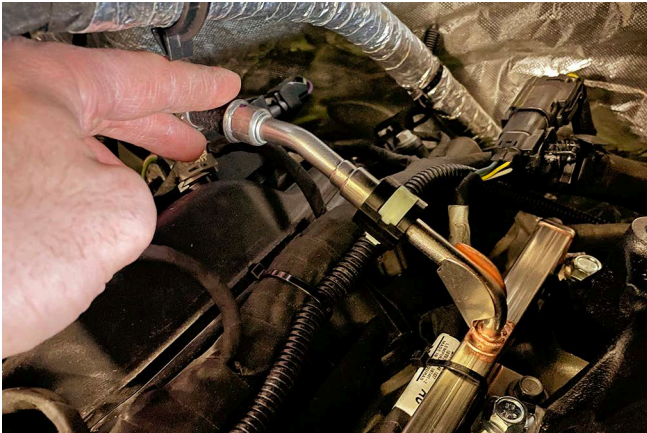

PCV PURGE HOSE

1. Connect the straight fitting side of the PCV purge hose (PT00040960) to the supercharger.

NOTE: Make sure both sides of the hose connections are locked onto the fitting. Pull on the hose to make sure the connections are secured.

2. Connect the PCV purge line (PT00040960) to the PCV valve on the RH cam cover and the port on the RH side of the supercharger.



LOWER FEAD ASSEMBLY

1. Route the FEAD belt (K060810, found in 1121-KIT1) as shown. Do not route the belt onto the supercharger pulley yet.

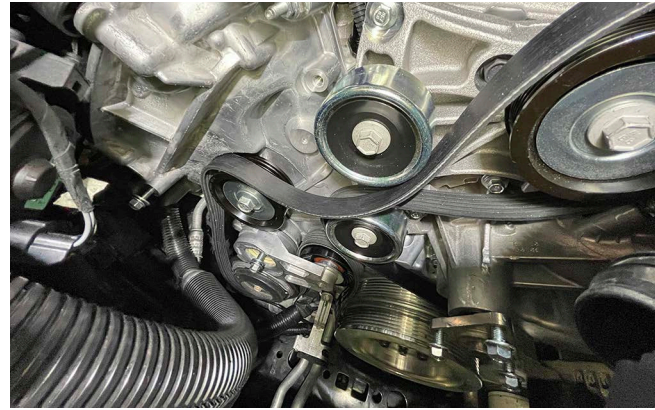

2. Install tensioner FS00056749 found in 1121-KIT1. Feed the belt around the tensioner. Torque the tensioner bolt, saved from earlier, to 25 Nm.

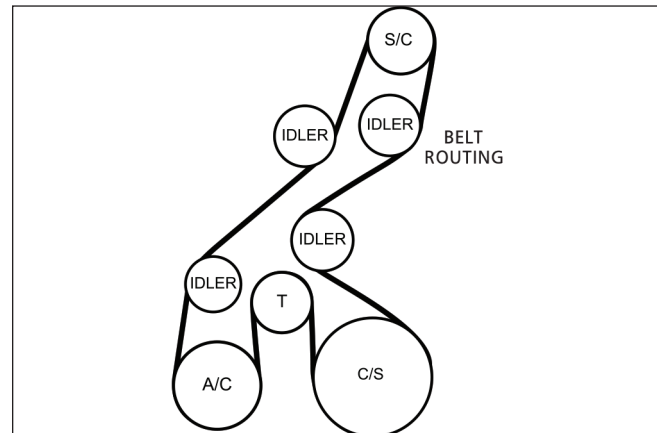

3. Using a 3/8" breaker bar or ratchet, rotate the new tensioner clockwise to install the belt on to the supercharger pulley. Inspect each pulley to ensure the belt is properly seated.



4. Re-install the water pump pulley using the three (3) removed bolts. Torque the bolts to 25 Nm (10 mm socket).

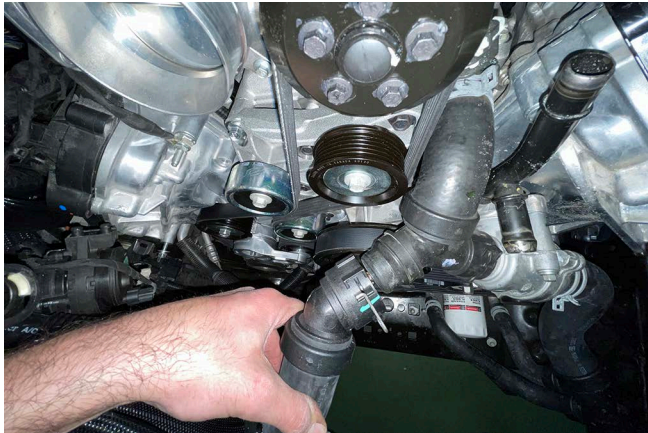

5. Re-install the stock FEAD belt (15 mm socket) by rotating the tensioner counter-clockwise and routing the belt as per the stock Ford belt routing.

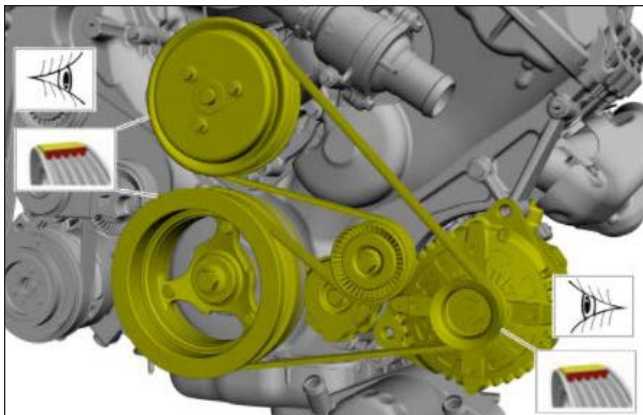

6. Install the heater hose on LH and RH cam cover.

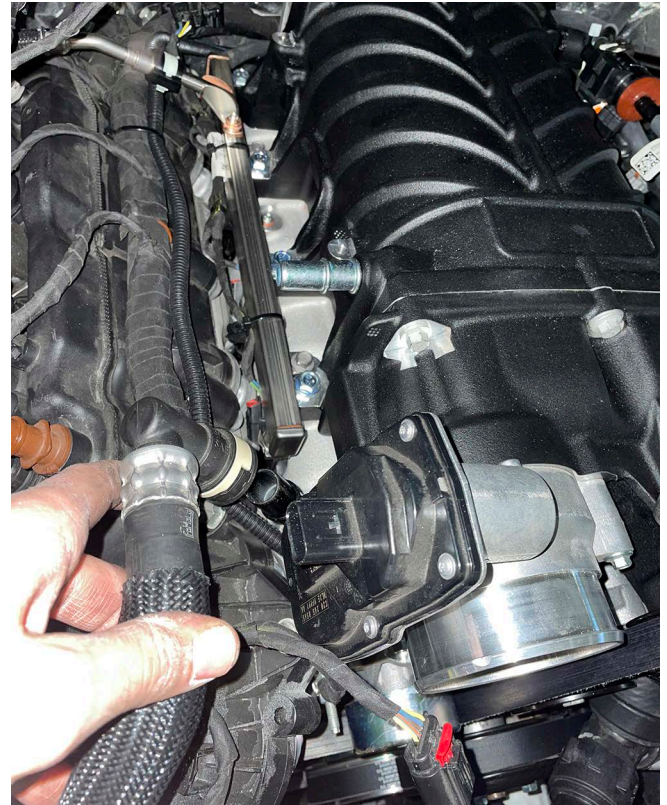

7. Zip tie heater hose to ensure clearance to throttle body. See below image.

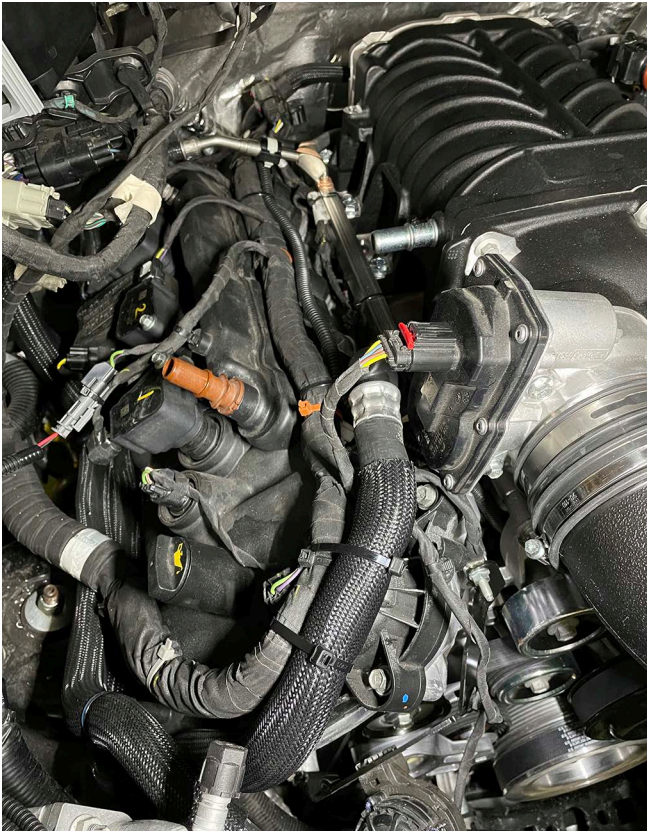

HEATER BRACKET MOUNTING (FOR 22MY, JUMP TO APPENDIX A)

1. Locate the heater pump bracket (PT00038880) and insert the pump into the bracket. Install the clips, saved from earlier, to retain the pump.

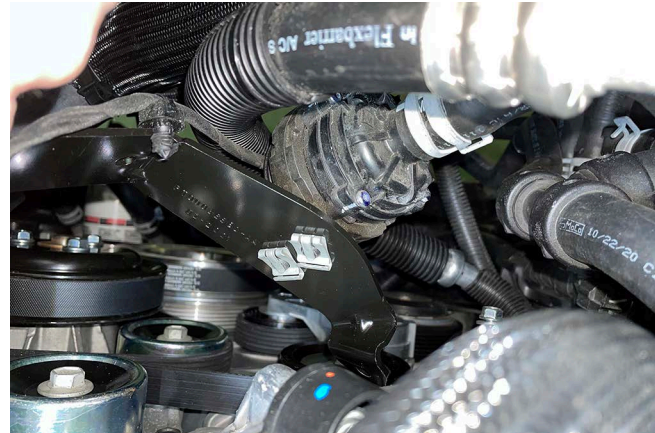

2. Install the heater bracket and the pump to the front cover. Torque the fasteners to 10 Nm. Install the wiring push pin into the hole in the new heater pump bracket.



INTERCOOLER RESERVOIR MOUNTING

1. Remove the bolt attaching the radiator overflow tank to the fan shroud at the left (driver) side. Set the bolt aside; this bolt location will be used for the degas bottle mounting bracket attachment.



2. Using the degas bottle-to-fan shroud mounting bracket (PT00041029, found in 1121-KIT3) as a

template, mark and drill a new mounting hole in the fan shroud using a 1/4" drill bit.



3. Install a M6 J-clip (N623332-S439, found in 1121-HWKG) over the drilled hole.



4. Place the mounting bracket (PT00041029) in position on the fan shroud with the RH mounting hole under the overflow tank and the left hole over

the new J-clip. Install the original overflow tank bolt in the RH mounting hole and an M6 x 1.0 x 20 bolt (W500214-S437, found in 1121-HWKG) to secure the bracket in the lower LH J-clip. Torque to 10 Nm.



5. Connect the bottom hose to the port and secure with clamp.

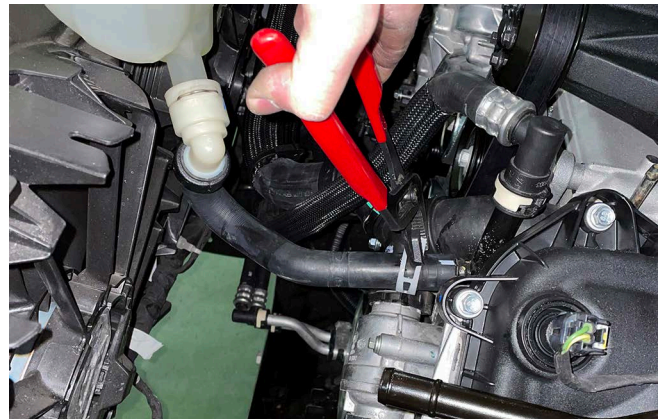

6. Install the degas bottle (1115-8D028, found in 1121-KIT3) over the two (2) studs on the mounting bracket. Install two (2) M6 nuts (W520412-S437, found in 1121-HWKG), over the studs and torque to 10 Nm.



INTERCOOLER PUMP MOUNTING

1. Place the intercooler pump bracket (1118-8C4192, found in 1121-KIT3) (hoop-style bracket in photo) onto the intercooler pump (FS00057975, found in 1121-KIT3). Install the pump and bracket onto the intercooler pump mounting bracket (PT00041036, found in 1121-KIT3) (larger bracket in photo) as shown and hand tighten the clamp bolt (W500214, found in 1121-HWKG). Do not fully tighten the bolt at this time to allow for proper alignment of the inlet and outlet ports during installation in the vehicle.

7. Connect the degas hose to the port on the thermostat neck and secure it with clamp. **NOTE:** For Dual Alternator Vehicles, cut 2 inches from hose prior to connecting. Route under clean air tube.

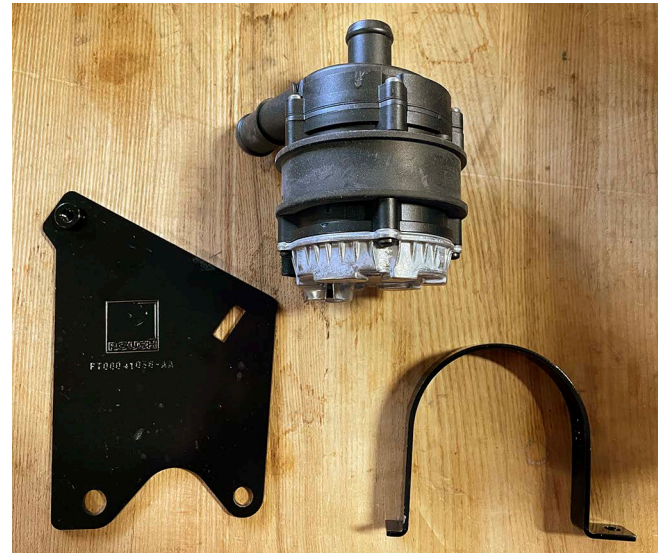
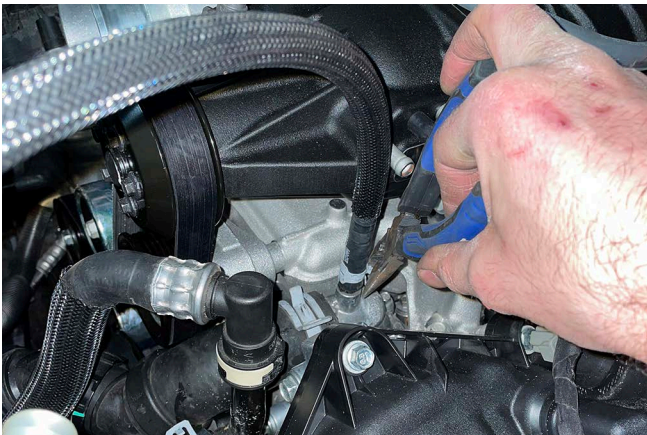

8. Connect the degas hose to the bottle and secure with clamp.

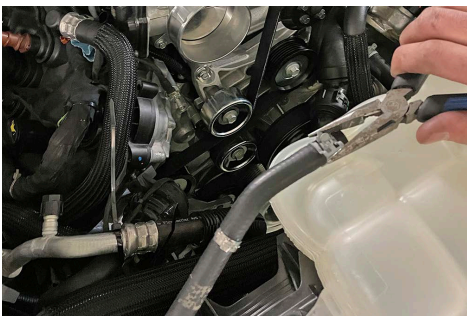



2. Install the pump and bracket assembly on the front left frame rail using two (2) M8 x 1.25 x 29 bolts (N808920, found in 1121-HWKG). Torque the bolts to 25 Nm.

NOTE: Bias the bracket vertically while fastening to ensure pump clearance to the lower radiator hose.

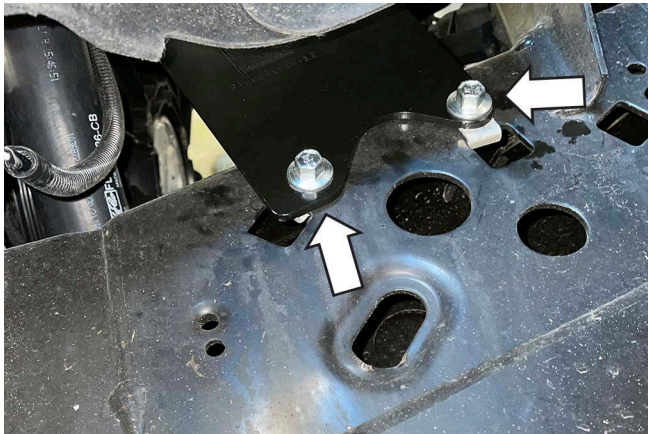

COOLANT HOSES

Intercooler Hose Circuit

These are the four (4) 3/4" hoses (found in 1121-KIT3) that make up the intercooler circuit.



1. Intercooler pump inlet hose (PT00040587)
2. LTR outlet hose (PT00040588)
3. Intercooler pump-to-LTR hose (PT00040441)
4. Intercooler reservoir inlet hose (PT00040444)

NOTE: Route all intercooler hoses very carefully. It is critical for intercooler performance that these hoses are not kinked once installed into the vehicle.

Starting at the top of the engine, install the hoses as follows.

1. Locate PT00040444, intercooler reservoir hose. Connect end A of the intercooler reservoir hose to the hard line assembly (left hand side in the picture below). Secure using one (1) 3/4" constant tension clamp (CT19X12-BO, found in 1121-HWKG).



2. Connect side B of the intercooler reservoir inlet hose to the side port of the degas bottle and secure with one (1) 3/4" constant tension clamp (CT19X12-BO, found in 1121-HWKG).

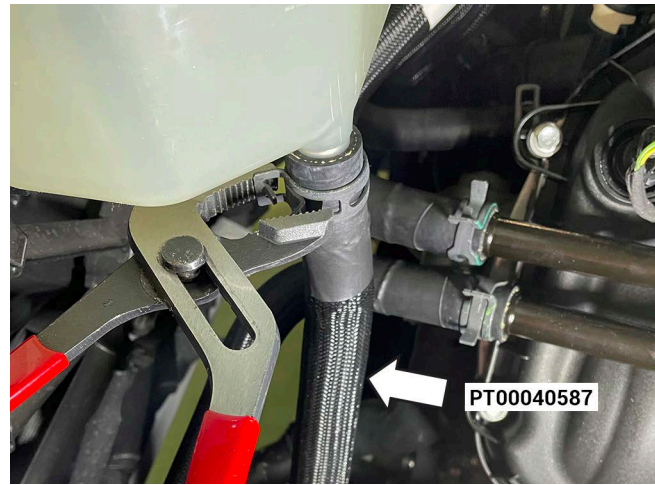

4. Connect hose end B of the intercooler pump inlet hose (PT00040587) to the inlet port of the intercooler pump using one (1) 3/4" constant tension clamp (CT19X12-BO found in 1121-HWKG)



3. Locate intercooler pump inlet hose PT00040587. Connect end A to the degas bottle outlet port (bottom port of the degas bottle pictured below) using one (1) 3/4" constant tension clamp (CT19X12-BO, found in 1121-HWKG).



5. Connect the intercooler pump electrical jumper harness (PT00042003) to the pump. Then, using a zip tie, secure the harness to the hood latch cable.



2. Locate the four (4) M8 x 1.25 x 16 bolts and four (4) M8 x 24 washers (FS00056117 and FT00000528, found in 1121-HWKG). Install the LTR from the rear of the modified active grill shutter. Insert the pins into the isolators grommets first (some assembly lubrication on the grommets can assist in the install). Install the four (4) M8 X 1.25 X16 bolts with four (4) M8 X 24 washers into the top of the LTR and torque to 20 Nm.

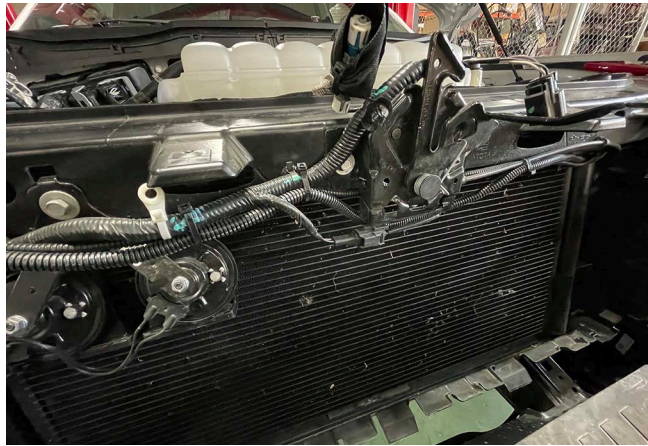

LTR INSTALLATION

1. Locate the three (3) grommets (R07060107-13, found in 1121-HWKG). Install the grommets in the 1/2" drilled holes in the modified active grill shutter.



3. Locate the LTR outlet and low temp rad inlet hoses (PT00040588 (or for **Dual Alt Vehicles** PN: **PT00048098**) and PT00040441 found in 1121KIT3). Locate two (2) 3/4" constant tension clamps (CT19x12-BO found in hardware kit 1121-HWKG). Install PT00040588 or **PT00048098** to the LTR outlet and PT00040441 to LTR inlet.
4. Install active grill shutter, grill, and LTR assembly. As you are installing the LTR assembly, feed the low temp rad outlet (PT00040588) and intercooler pump to the LTR (PT00040441) through the modified cutout. After the hoses have been feed into the engine bay, slide the assembly into location.

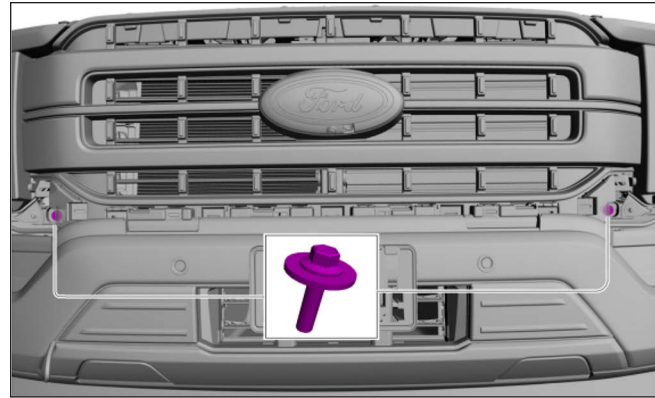

7. Ensure the grill clips are secure in the following pictured seven (7) locations.

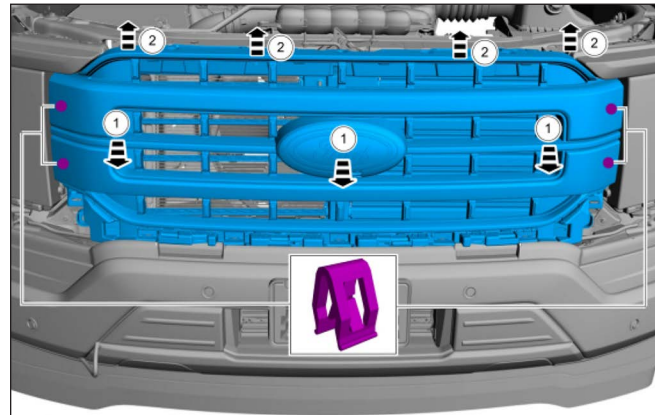
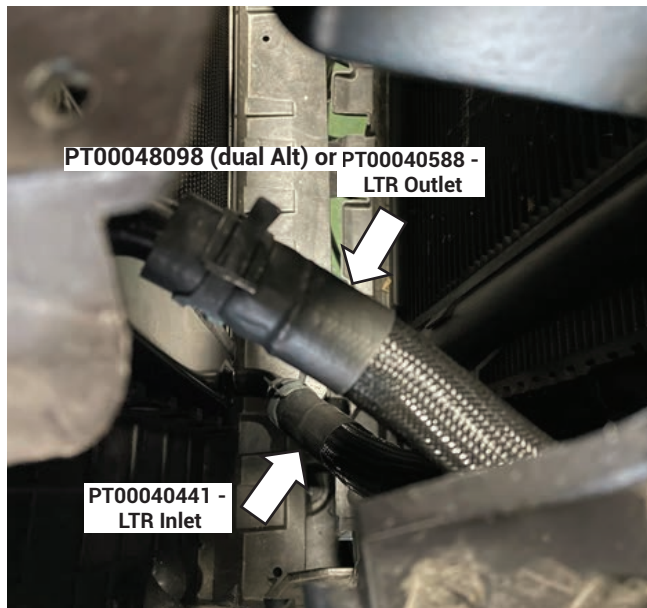

8. Install the front bumper upper cover trim panel. Install two (2) bolts in each wheel well that were previously removed. Torque to 15 in-lb.

5. Torque the four (4) fasteners to 4.1 Nm on the top of the active grill shutter. Install the pin-type retainers to secure the top of the active grill shutter.

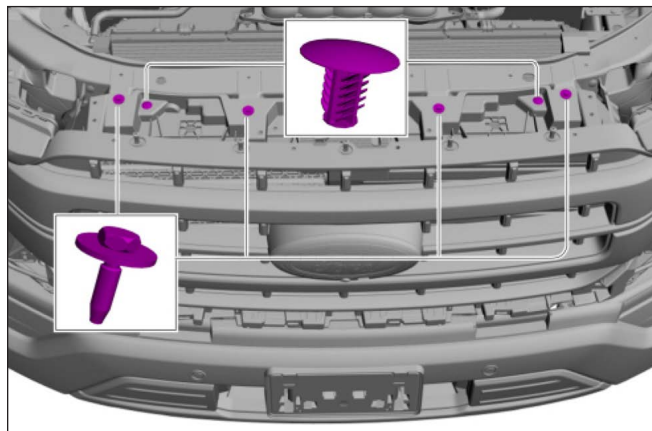
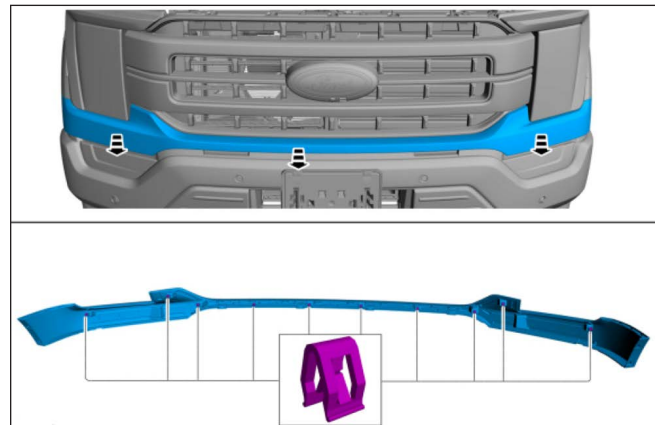

6. Torque the active grill mounting bolts to 18 Nm.

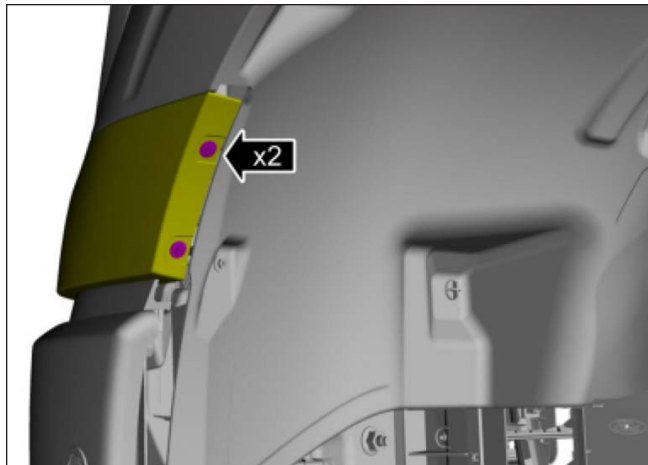

9. Locate hose PT00040441 intercooler pump-to-LTR hose. Connect side B onto the intercooler pump outlet using one (1) 3/4" constant tension clamp (CT19X12-BO, found in 1121-HWKG).



10. Locate PT00040588 LTR outlet hose. Connect side A of LTR outlet hose (PT00040588) to the hard line assembly (Right-hand side in picture below). Secure with one (1) 3/4" constant tension clamp (CT19X12-BO).

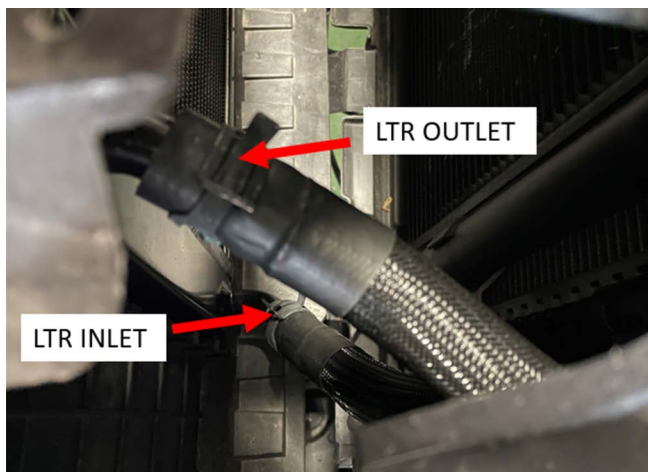

AIR INDUCTION SYSTEM

1. Install the OEM bolt, grommet and sleeve into the driver side fender. Tighten the bolt to 17.5 Nm. Place the new ROUSH air box and OEM dirty air duct assembly in position on the vehicle. Align and slide the edge slot of the air box into the rubber isolator and secure the assembly in place with the two (2) original push pins at the front of the dirty air duct.



2. Install the new clean air tube assembly (1115SC-9B660) into position between the throttle body and the MAF tube. Torque the clamps on each end to 3 Nm. Throttle body uses take off clamp removed from earlier.

SECTION E – FINAL ASSEMBLY

1. Fill the engine cooling system (using a proper coolant mixture) to the marked level on the radiator degas bottle. Make sure the radiator petcock is closed tightly.
2. Using the same coolant mixture, fill the intercooler system through the degas bottle. The coolant should be approximately one inch below the top of the cap. Install the degas bottle cap (9C3Z-8101) and tighten when full.

IMPORTANT: Both coolant systems can trap a large amount of air. It is very important to verify that the air is purged and that coolant is flowing properly through both systems. ROUSH recommends vacuum filling both systems to properly evacuate the trapped air.

3. Inspect all underhood wiring harnesses for potential interference issues. Use zip ties to safely position the harness away from any areas of concern.
4. If the vehicle is not flashed yet refer to the PCM Flashing section. **DO NOT ATTEMPT TO START THE VEHICLE IF THE PCM IS NOT EQUIPPED WITH A ROUSH CALIBRATION. OPERATING THE ENGINE WITHOUT THE RECALIBRATED PCM WILL RESULT IN ENGINE DAMAGE OR FAILURE AND WILL VOID THE WARRANTY.**
5. Re-install the battery terminal connections by connecting the positive (+) cable first then connecting the negative (-) cable.
6. Reconnect the fuel pump control module electrical connector located above the spare tire on the frame.
7. Place the PCM warning sticker (R0700008-10, found in 1121-HWKF) above the PCM on the cowl of the vehicle.



8. The belt routing diagram (PT00038645, found in 1121-HKWF) is to be placed on the underside of the hood, on the driver side, opposite of the factory Vehicle Emission Control Information decal.

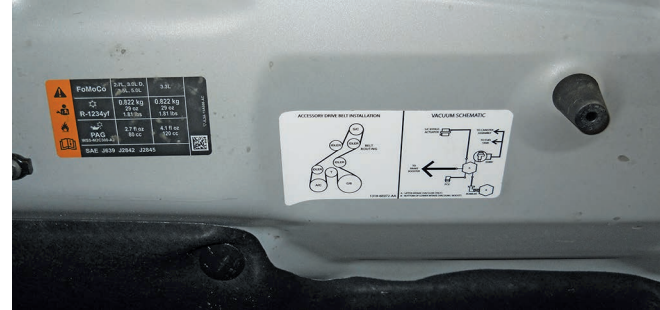

9. Place the fuel door decal (13109A095, found in 1121-HWKF) on the backside of the fuel door. With the supercharger system installed, the vehicle is no longer E85 compatible. If your vehicle has a Flex-Fuel badge, it is recommended that this also be removed at this time.



10. Place the "Premium Fuel" clear decal with white lettering (R07110004-11) on the instrument cluster bezel, on the flat area below the small center gauges as shown.

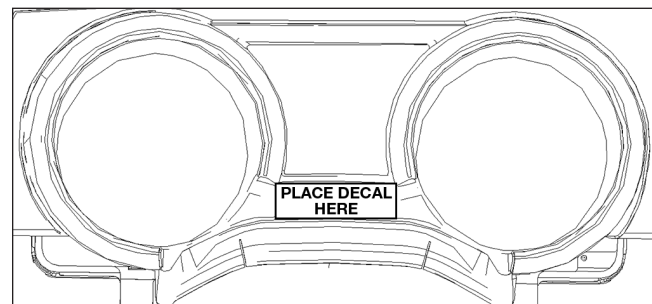

11. Clean the oil fill cap and install the 5W50 sticker (1318-5W50ST) to the cover. Parts found in 1121-HWKF.



PCM FLASHING

1. Download RDT (ROUSH Diagnostic Tool, <https://rdt.roush.com/RoushRDT/>) to flash vehicle PCM with ROUSH calibration. OPERATING THE ENGINE WITHOUT THE RECALIBRATED PCM WILL RESULT IN ENGINE DAMAGE OR FAILURE AND WILL VOID THE WARRANTY. (RDT VERSION 20.07.0026 OR LATER IS REQUIRED TO COMPLETE THE PROCESS.)
2. Launch RDT and connect to vehicle using a J2534 device. The following screen will be displayed.

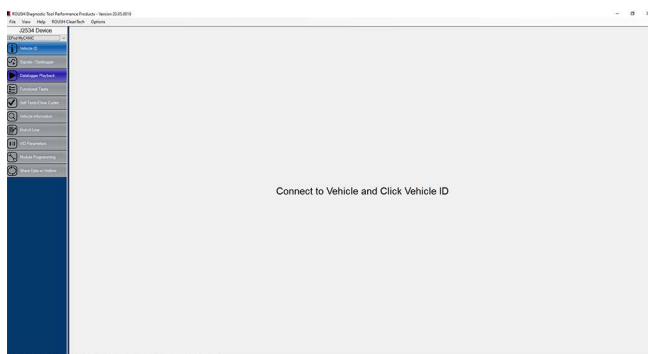

3. Locate voucher card (P1121-P1CAL, found in 1121-HWKF). Enter Module Programming to install the ROUSH calibration for your supercharger.

NOTE: See Appendix B for pictures that walk through the entire module programming process.

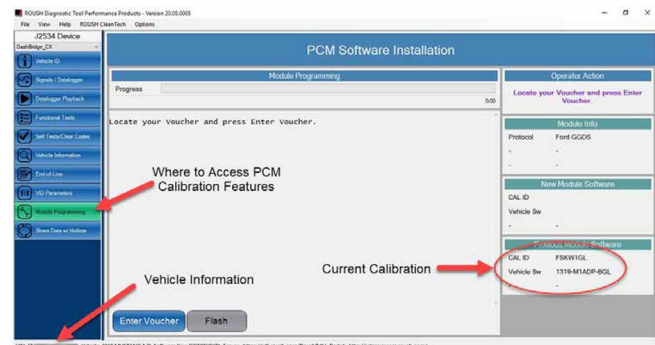

4. **After the PCM is flashed, you will need to go through the end of line process to finish the calibration install.** Once completed, a warranty certificate is created. Print the certificate and save so you have a record of when the warranty period began. A blank certificate is shown on the next page.

NOTE: See Appendix C for pictures of the end of line process.

5. Once the PCM has been successfully re-calibrated, start the engine and check for unusual noises, dash service lights, and unusual operation. If problems are detected, immediately stop the engine or vehicle, diagnose and repair the problem.

Congratulations, you can now go enjoy your new ROUSHcharged 5.0L F-150.

ROUSH® Performance Limited Base Warranty

Calibrated Super Charger Kits

The ROUSHcharger is protected for the earlier of 3 years or 36,000 miles from the date of installation.

VIN: _____

Installing Dealer Name _____ Mileage at Installation: _____

Dealer Phone No. _____ Install Date: _____

EOL Performed (Y/N): _____ Premium fuel (Y/N): _____

Start Date of Warranty: _____ Misfire Profile Monitor (Y/N): _____

Spark Plug Installed PN: _____



SECTION F – TEMPLATES

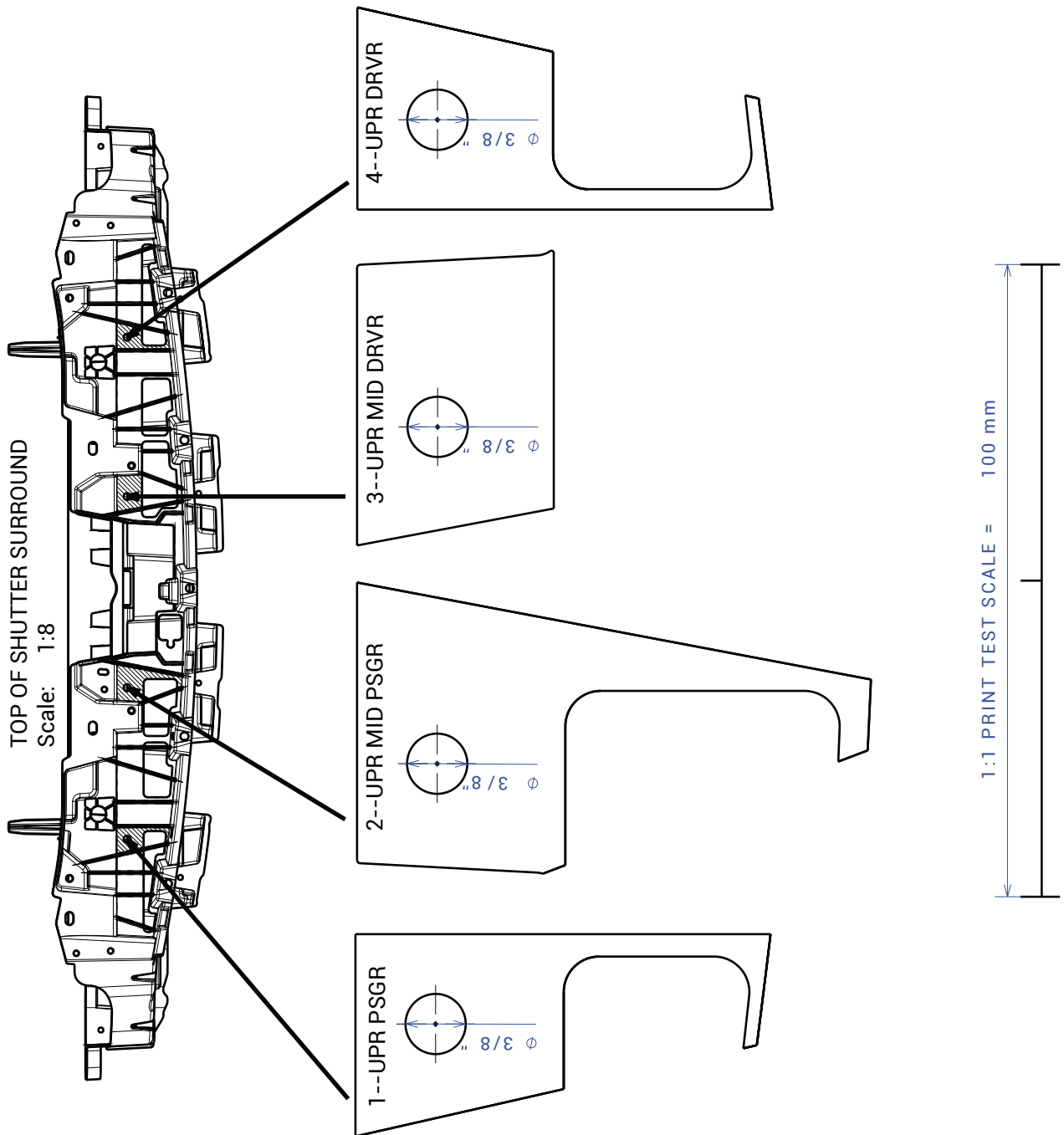

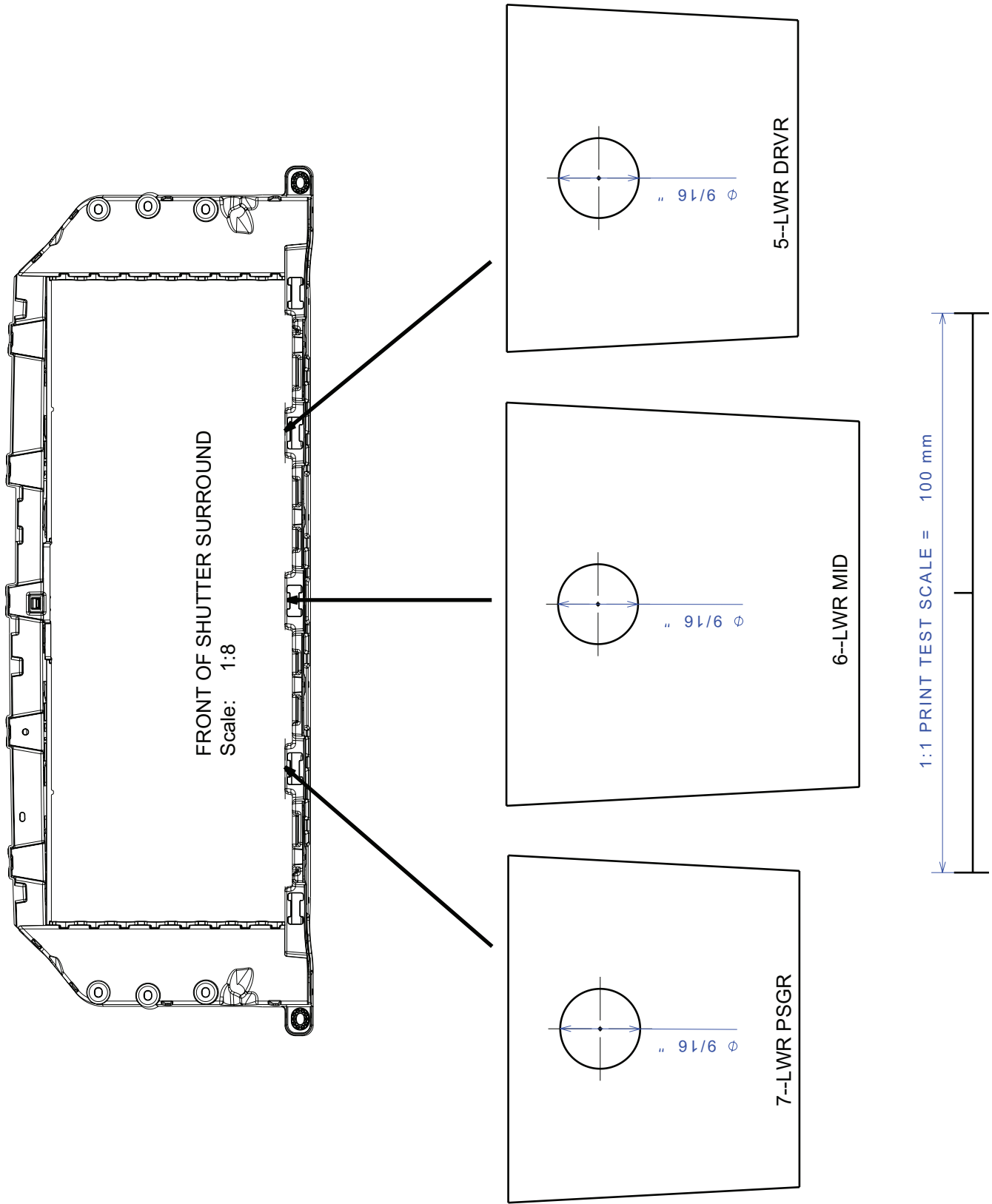

APPENDIX A – HEATER HOSE MODIFICATION

1. Locate stock heater hose and remove two (2) zip ties.

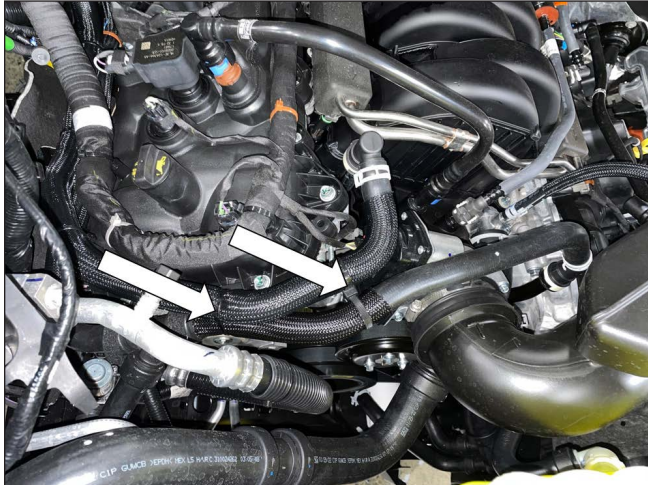

2. Cut stock heater hose in half at pictured location below.

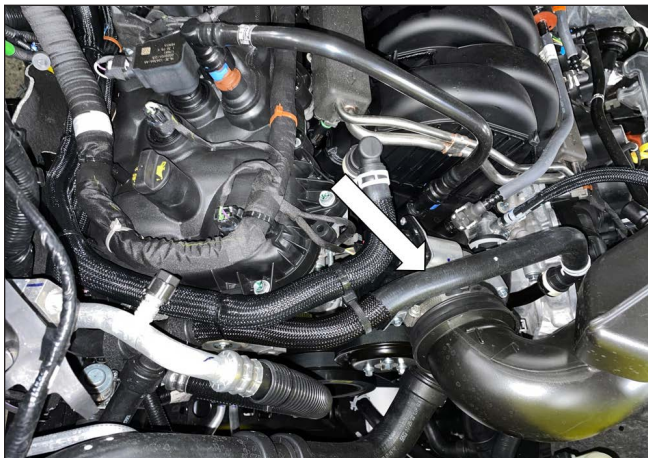

3. Locate one (1) hose 1115-8D030 (found in 1122-HWKA). Cut in shown locations. Modified hose will fit between cut stock heater hose and stock heater hose fitting.

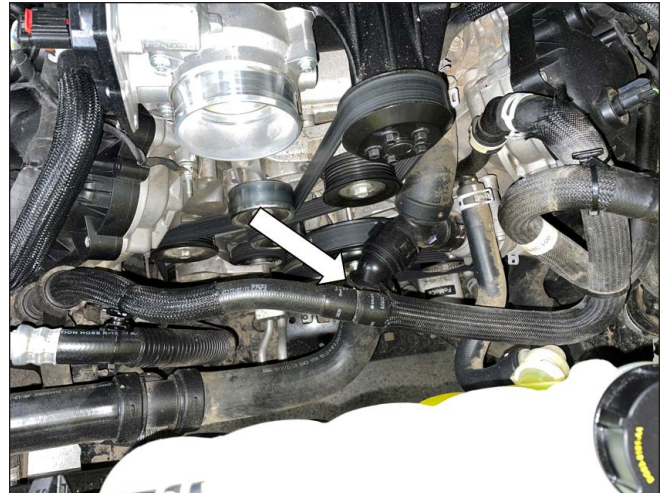

4. Locate one (1) connector 28605 and one (1) 3/4" constant tension hose clamps CT19x12-B0 (found in 1122-HWKA). Insert connector into cut heater hose and apply 3/4" constant tension clamp.



5. Remove stock heater hose fitting and install into cut end of 1115-8D030. Connect heater hose fitting to engine side fitting.

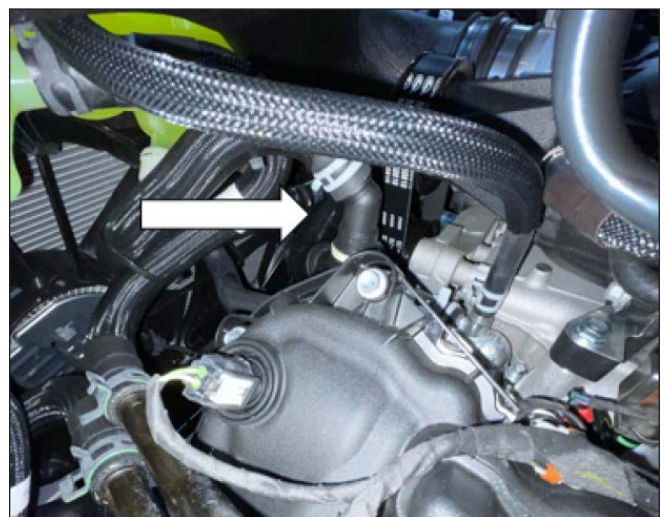

6. Locate one (1) 3/4" constant tension hose clamp CT19x12-B0 (found in 1122-HWKA). Install modified 1115-8D030 hose onto straight connector previously installed into stock heater hose and install clamp as pictured.

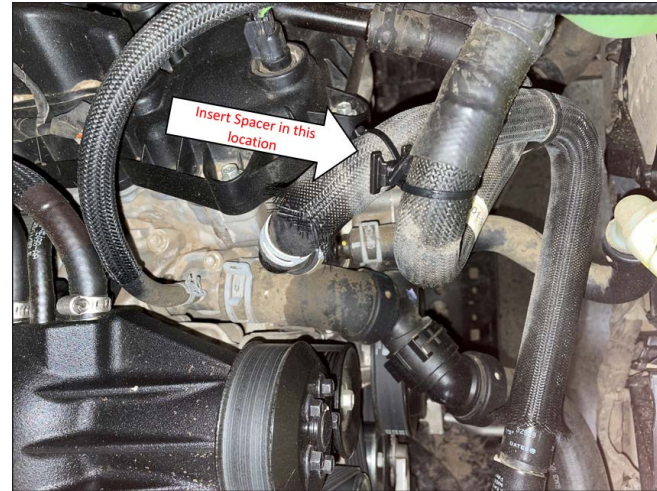
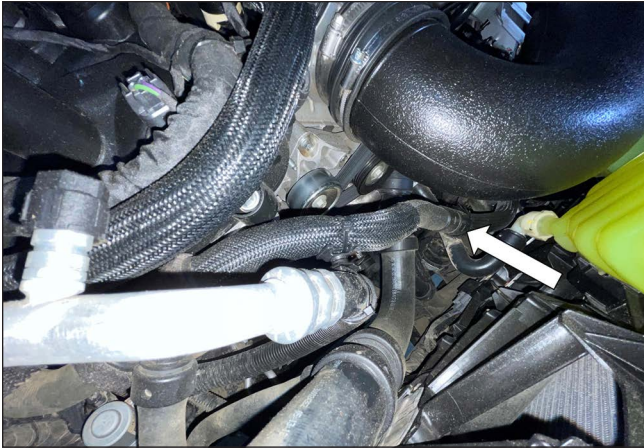

7. Locate two (2) 1151-06500 spacer-dual swivel saddle and four (4) 8" zip ties (located in hardware kit 1121-HWKA). Install spacer-dual swivel saddle spacer and zip ties in 2 (two) locations to prevent hose chafing. Ensure zip tie is located on convolute/sleeving.

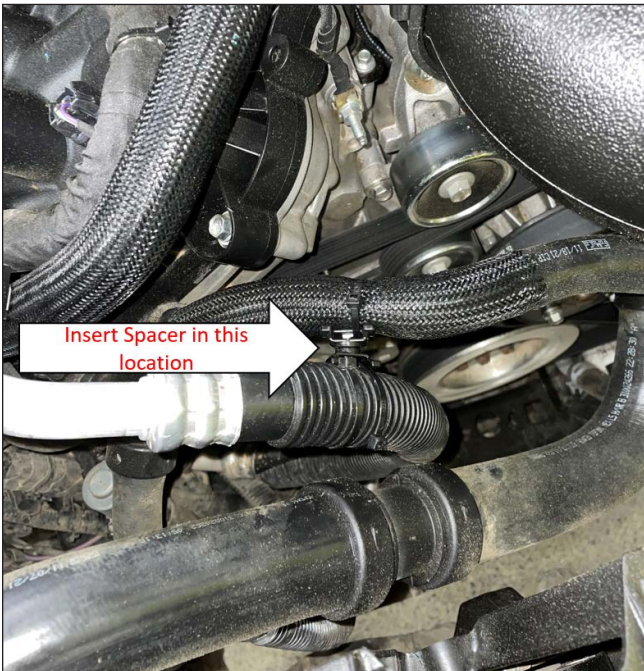

APPENDIX B – MODULE PROGRAMMING

The following pictured steps will guide you through the module programming flash process to install the new Roush calibration.

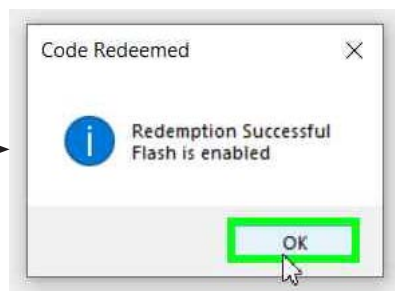
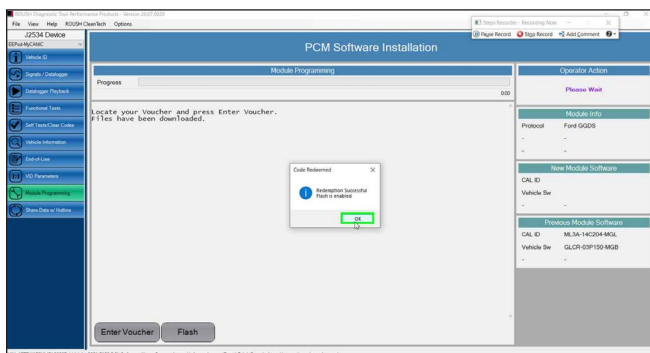
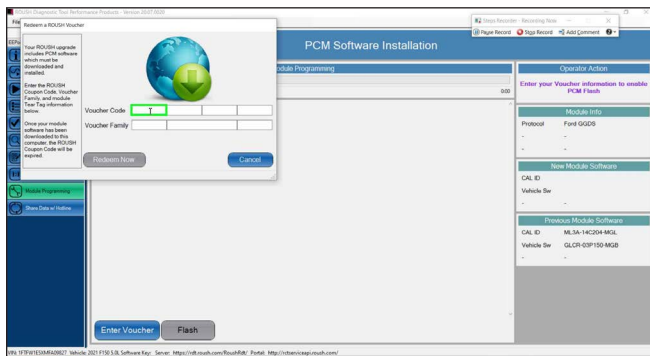
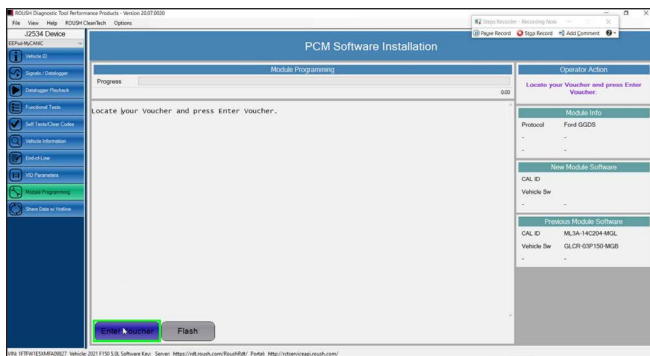
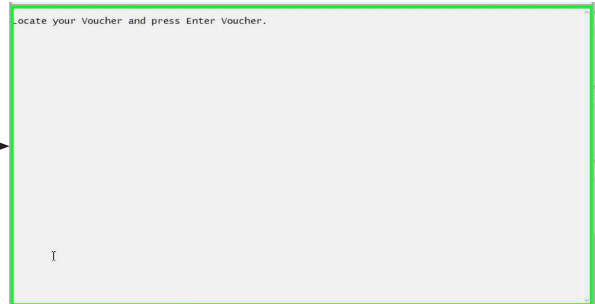
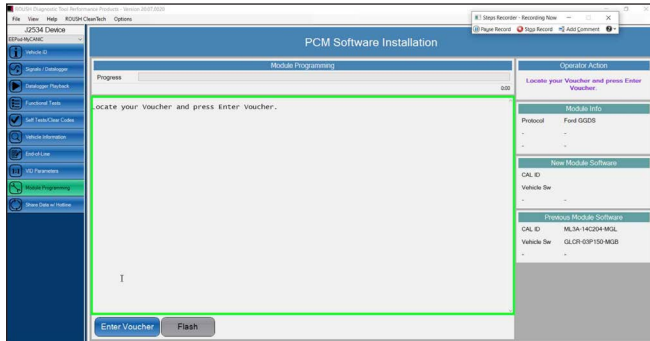

2021-2023 Ford F-150 5.0L ROUSHcharger Kit Appendix B – Module Programming

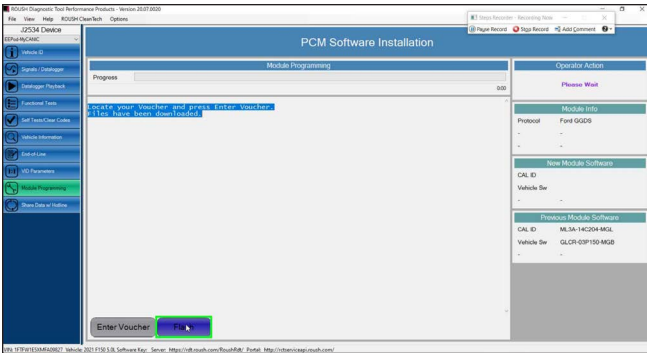

Locate your Voucher and press Enter Voucher. Files have been downloaded.

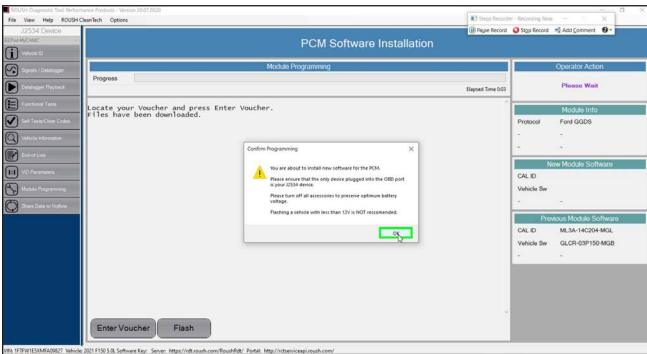

Confirm Programming

! You are about to install new software for the PCM. Please ensure that the only device plugged into the OBD port is your J2534 device. Please turn off all accessories to preserve optimum battery voltage. Flashing a vehicle with less than 12V is NOT recommended.

OK

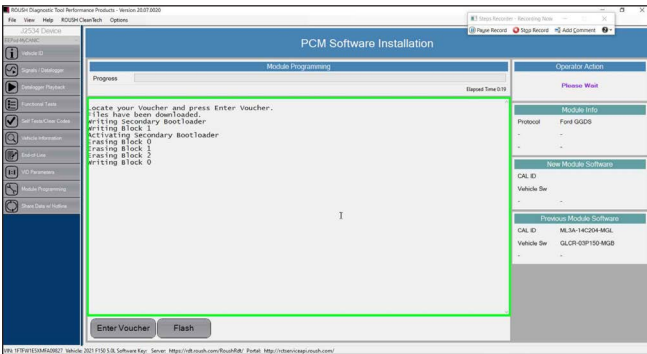

Locate your Voucher and press Enter Voucher. Files have been downloaded.

Writing Secondary Bootloader
Writing Block 1
Activating Secondary Bootloader
Erasing Block 0
Erasing Block 1
Erasing Block 2
Erasing Block 3
Erasing Block 4

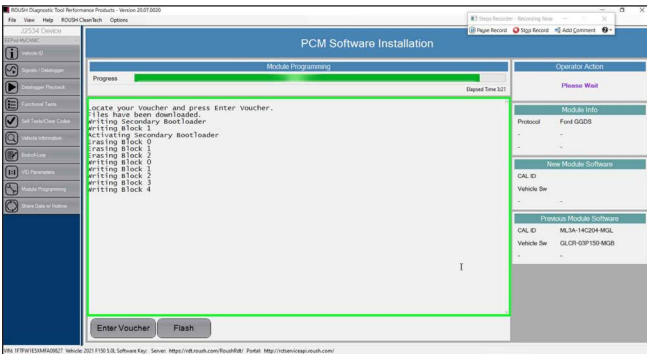

Locate your Voucher and press Enter Voucher. Files have been downloaded.

Writing Secondary Bootloader
Writing Block 1
Activating Secondary Bootloader
Erasing Block 0
Erasing Block 1
Erasing Block 2
Erasing Block 3
Erasing Block 4

2021-2023 Ford F-150 5.0L ROUSHcharger Kit Appendix B – Module Programming

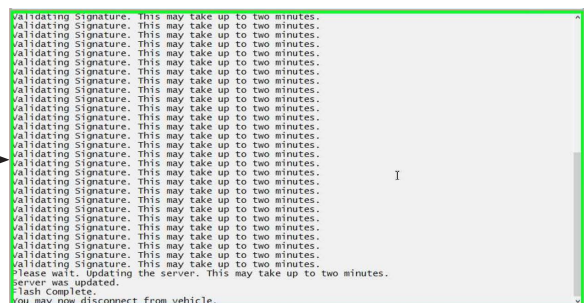
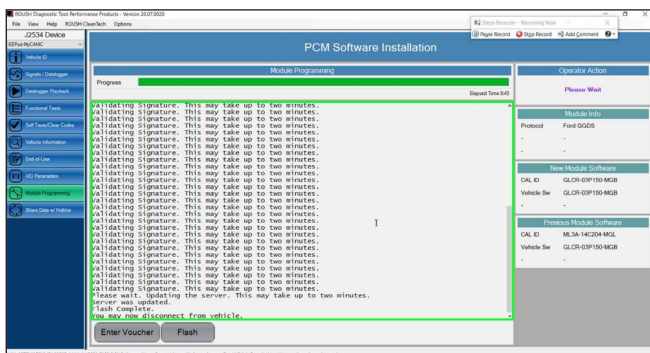
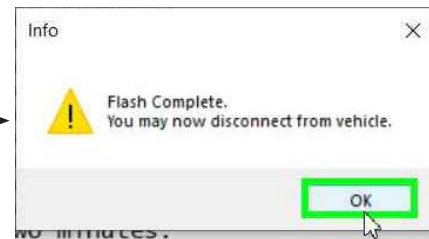
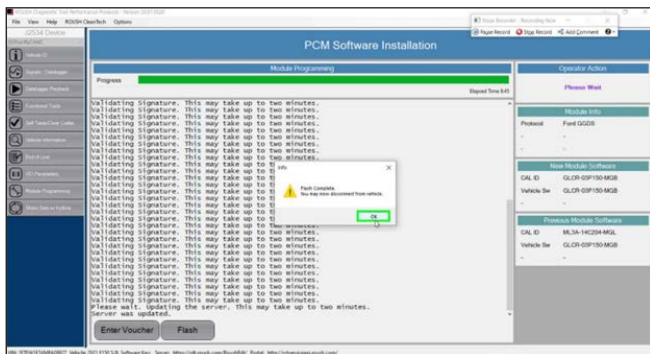
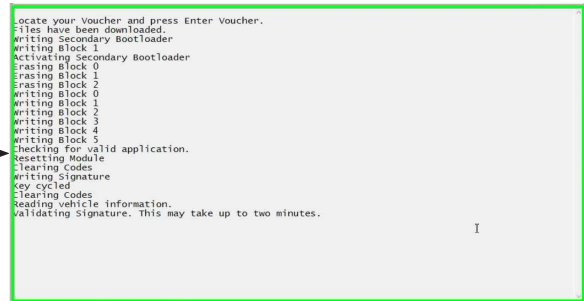
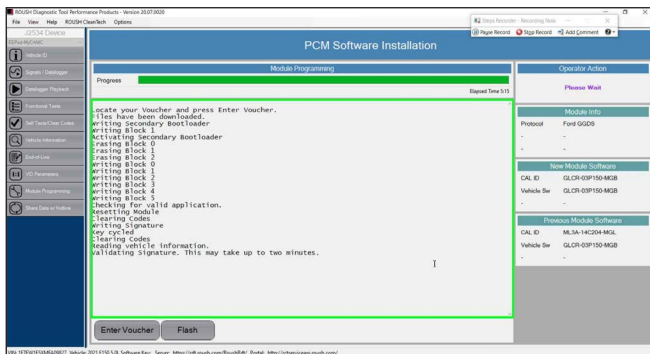
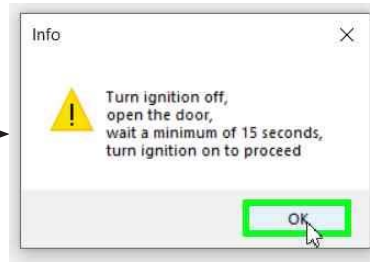
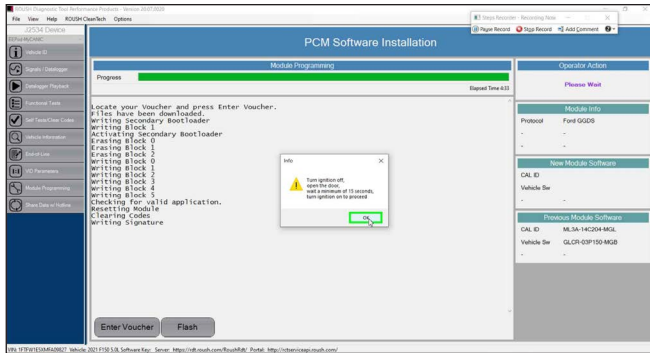

APPENDIX C – END OF LINE PROCEDURE

The following pictured steps will guide you through the end of line sequence to complete the install of the new Roush calibration. Once complete, you can print out the warranty start certificate.

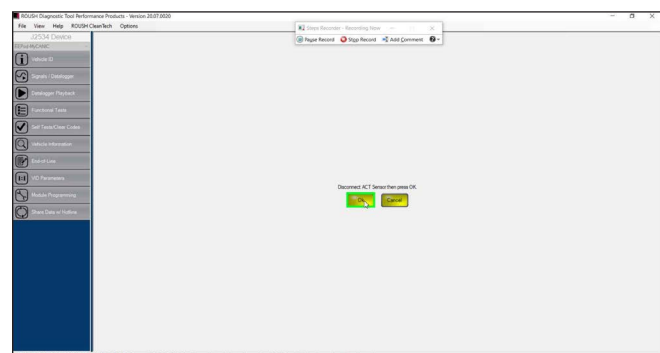
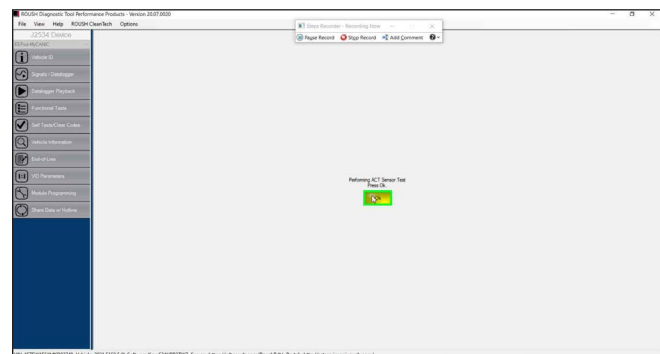
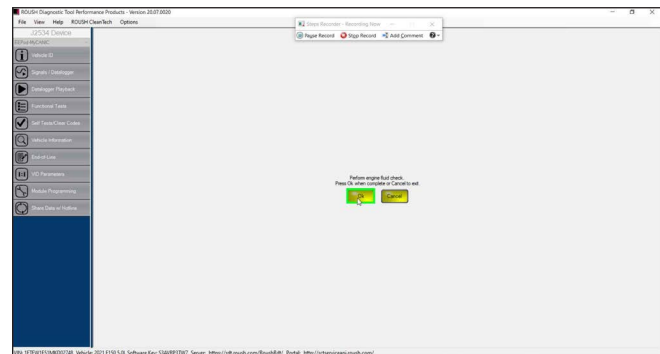
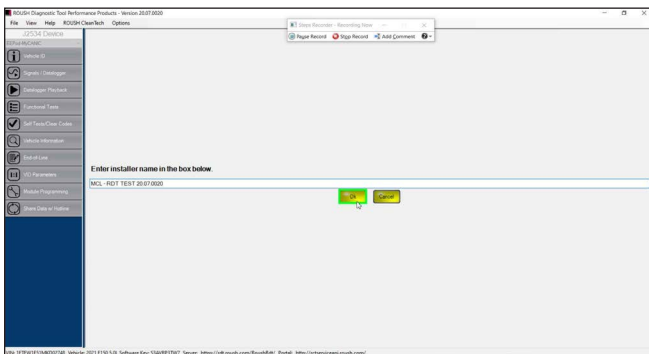
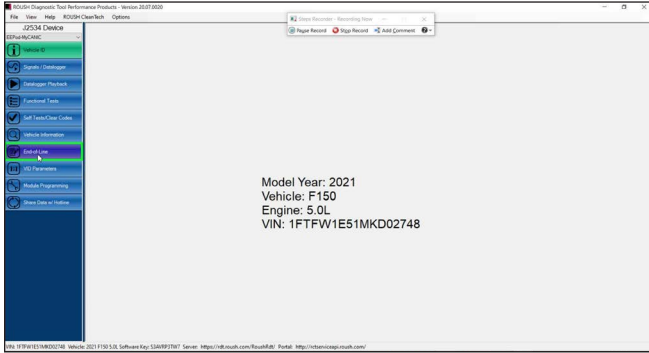

2021-2023 Ford F-150 5.0L ROUSHcharger Kit Appendix C – End of Line Procedure

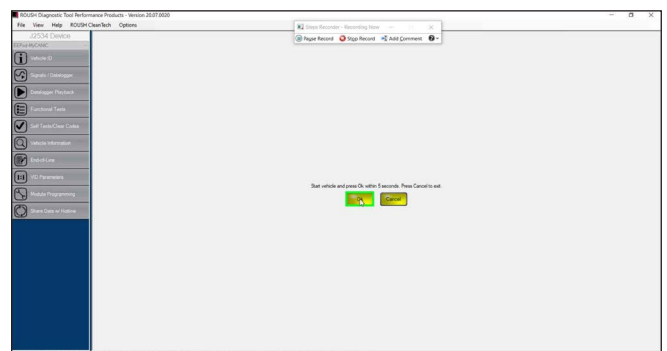
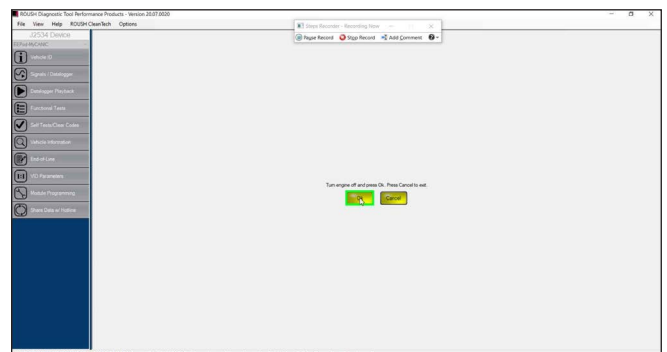
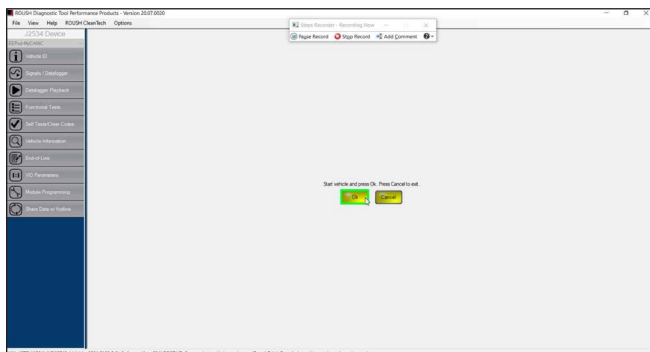
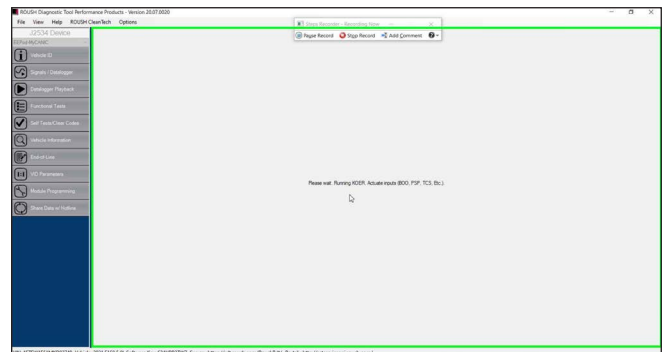
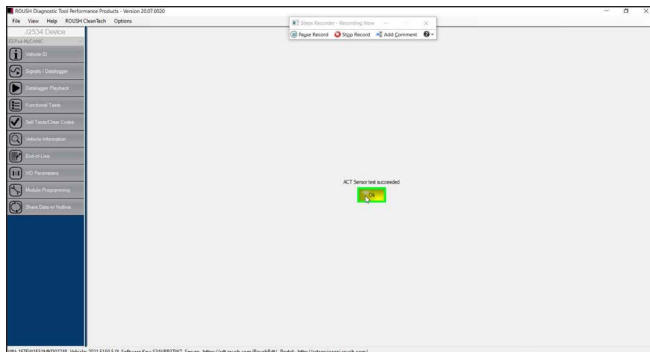

2021-2023 Ford F-150 5.0L ROUSHcharger Kit Appendix C – End of Line Procedure

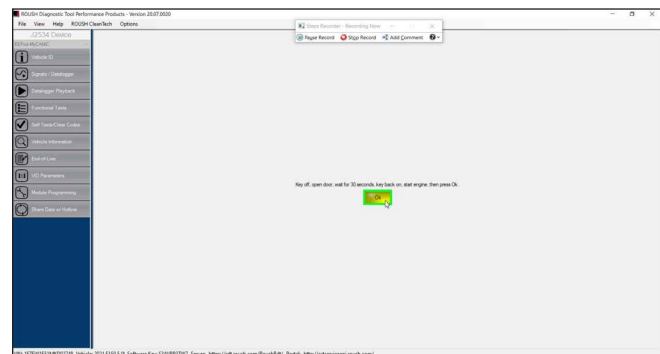
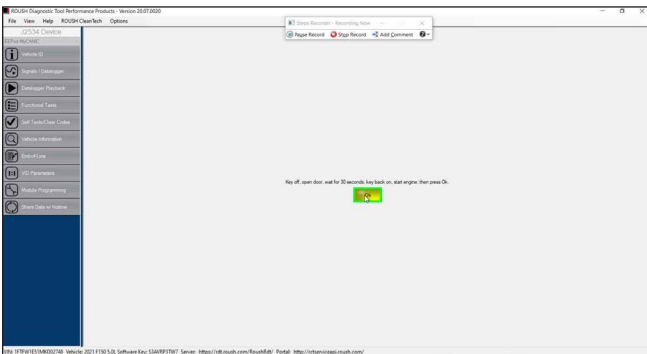
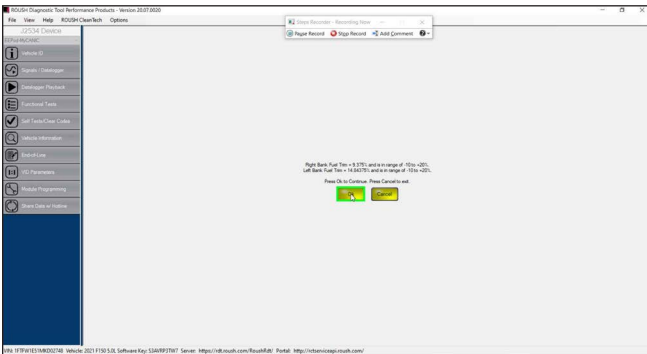
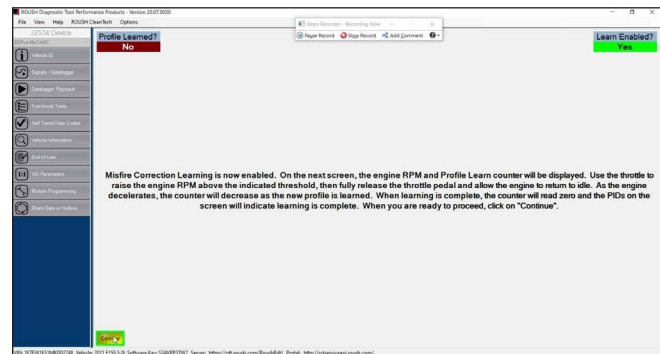
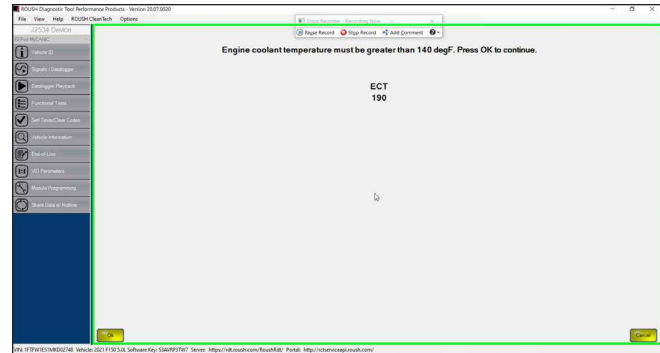
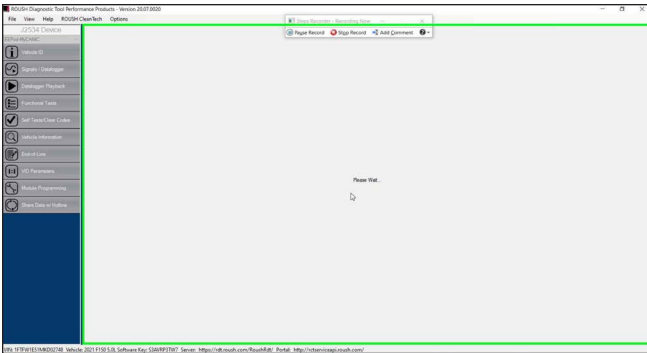

2021-2023 Ford F-150 5.0L ROUSHcharger Kit Appendix C – End of Line Procedure

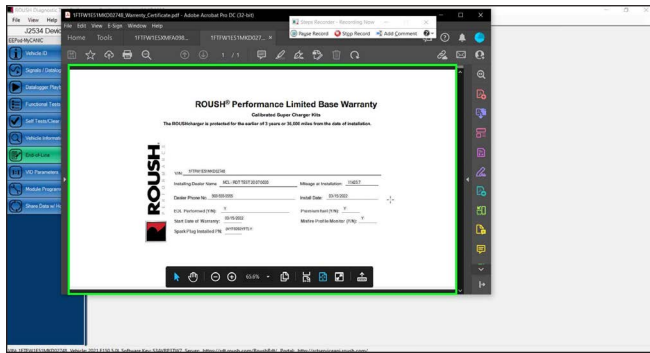
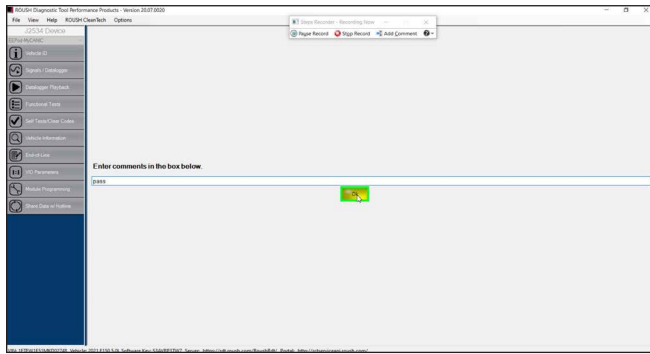
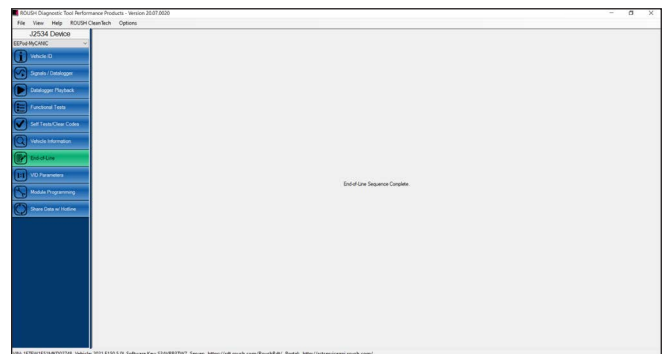
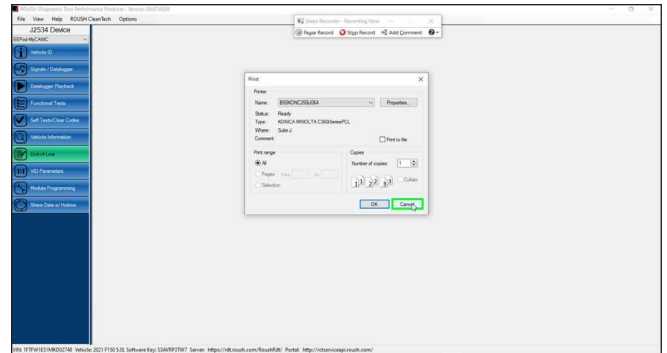
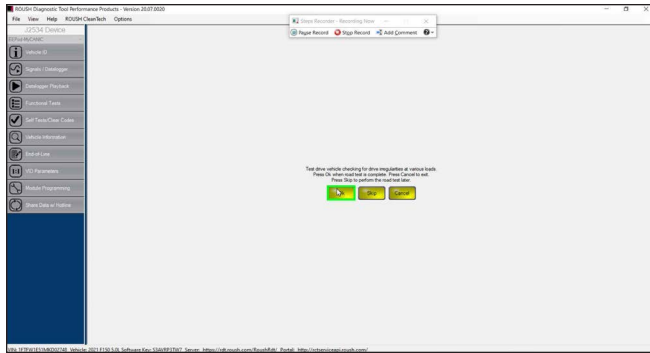

**APPENDIX D – DUAL ALTERNATOR
THERMOSTAT INSTALLATION**

The following pictured steps will guide you through the installation of the new Roush waterneck/thermostat housing.
NOTE: THIS STEP IS ONLY REQUIRED FOR DUAL ALTERNATOR PRO POWER ON BOARD VEHICLES.

1. Locate Housing PT00048357 and gaskets: FS00061700, FS00061699. Install gaskets into housing as pictured below.

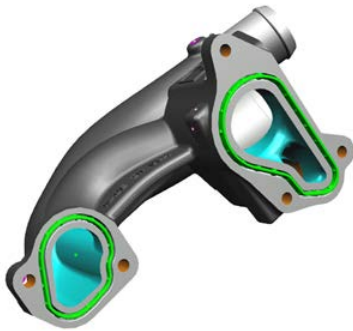

2. Locate the 4 take off fasteners for the housing engine thermostat. (M6x1.0X70 mm (2), M6x1.0X27 (2)). Install PT00048357 with installed gaskets. Torque fasteners to 10 Nm.

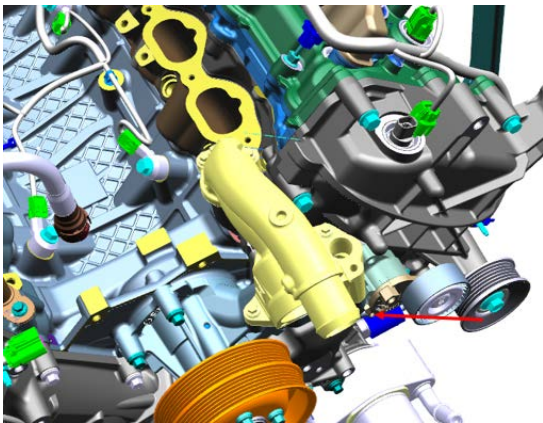

3. Locate O-Ring -Thermostat FS00061701 in hardware kit 1121-HWKDUAL. Locate the following components: thermostat removed earlier, connector water inlet, and 2 fasteners (M6x1.0x20). Install the Thermostat and the new O-ring FS00061701 and then install the connector water inlet. During installation verify the thermostat vent hole is at the 12 o'clock position. Torque fasteners to 10 Nm.

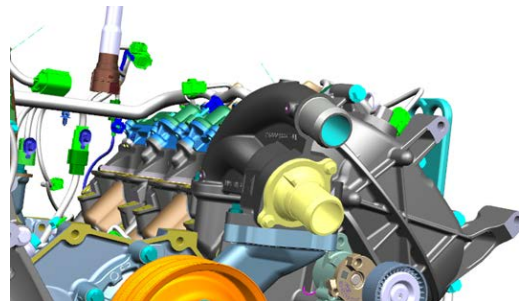
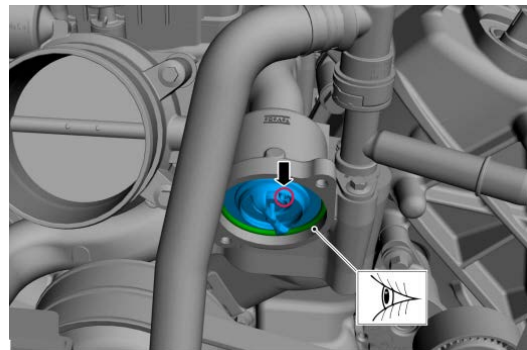
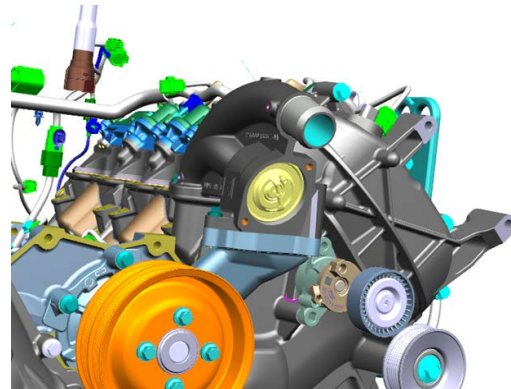

5. Locate Hose Assembly and the 1 fastener (M6x1.0X70). Apply lubrication to O-ring prior to installing. Install hose assembly and torque fastener to 10 Nm

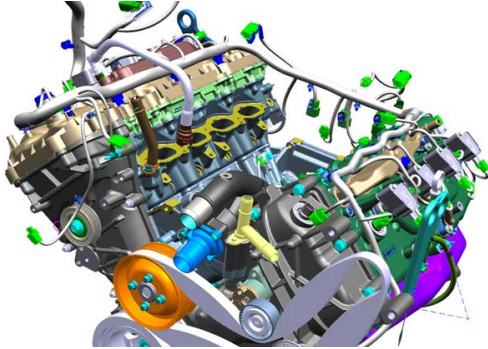

8. **22-23MY** Locate Hose – Upper Radiator PT00048095 and 2 hose spring clamps SP001491. Modify upper radiator hose to remove. Install radiator hose onto the water connector with spring clamp and onto the upper radiator hose T.

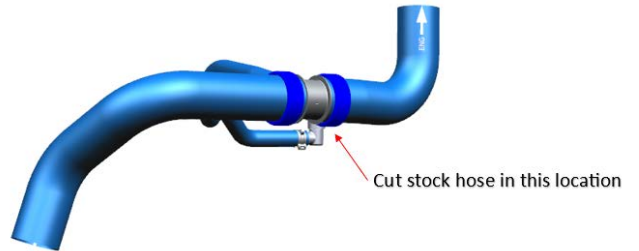

6. Locate fitting – NPT to Hose Barb in 1121-HWKDUAL. Put thread sealant (Loctite 567) on NPT threads prior to installation. Install NPT fitting into housing – engine thermostat.

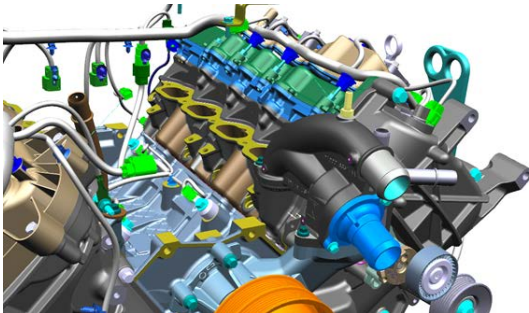

21-23MY Modified Hose

7. Connect the lower radiator hose to the water connector water inlet. Use take off clamp to secure the hose.

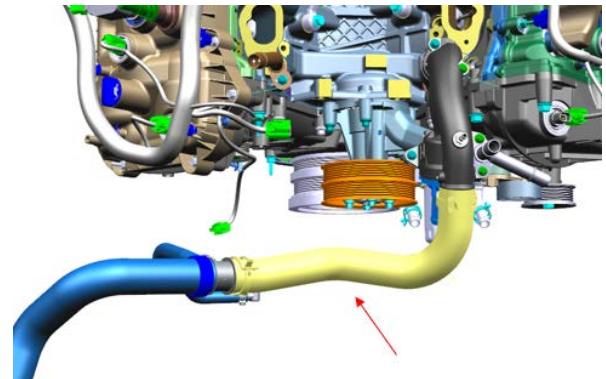
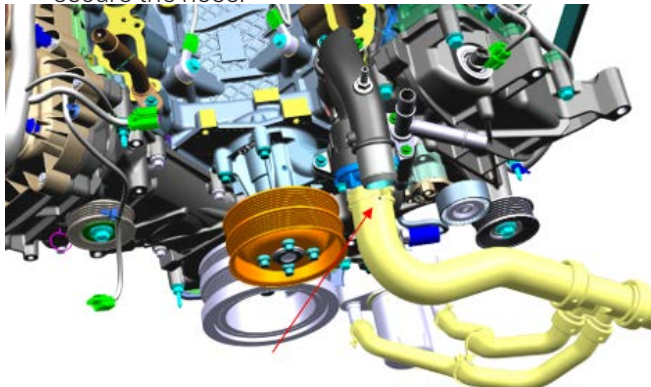

Note if you are installing onto a 21MY truck follow the below process.

8. **21MY Install:** Locate Hose – Upper Radiator PT00048095, 3 hose spring clamps SP001491, and fitting – radiator FS00061905 (found in Hardware kit 1121-HWKDUAL-AA). Install radiator hose onto the water connector with spring clamp. Locate stock upper radiator hose, removed from earlier. Install upper radiator hose and make a mark on the hose. Cut the hose at this mark (similar location as pictured below). Install fitting radiator into hose – upper radiator with spring clamp. Install the modified hose between new installed fitting and upper radiator.

9. Continue installation on page 47

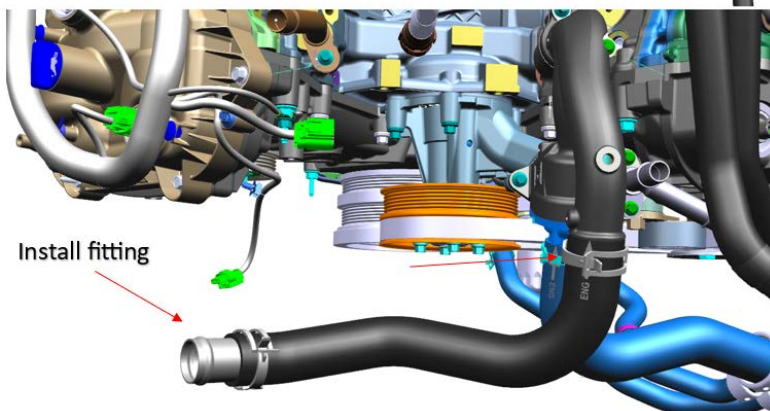
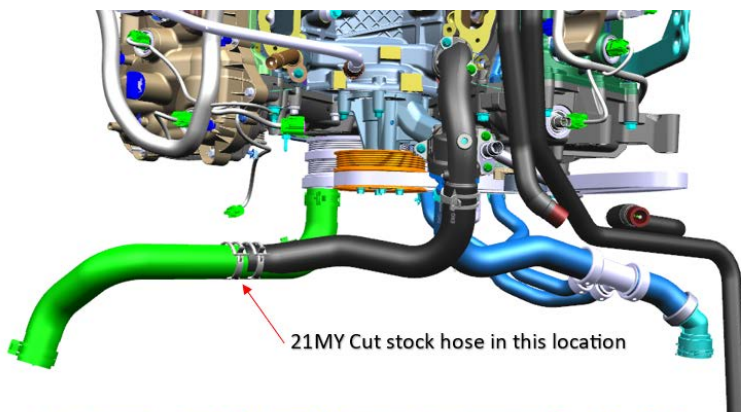
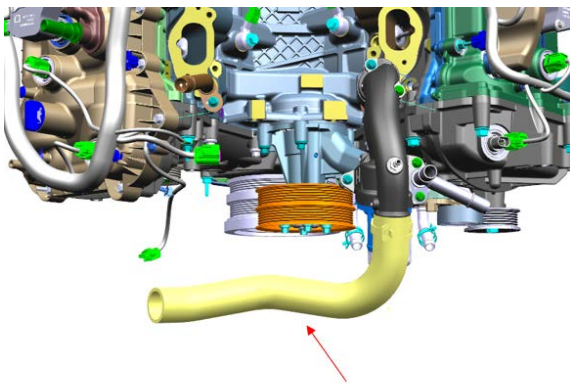

APPENDIX E – DUAL ALTERNATOR INTERCOOLER LINES INSTALLATION

The following pictured steps will guide you through the installation of the new Roush intercooler hoses. NOTE: THIS STEP IS ONLY REQUIRED FOR DUAL ALTERNATOR PRO POWER ON BOARD VEHICLES.

1. Intercooler Hose Circuit

These are the three (4) 3/4" hoses (found in 1121-KIT3)

1. Intercooler pump inlet hose (PT00048374)
2. LTR Outlet hose (PT00048098)
3. Intercooler pump-to-LTR hose (PT00040441)
4. Intercooler reservoir inlet hose (PT00048097)

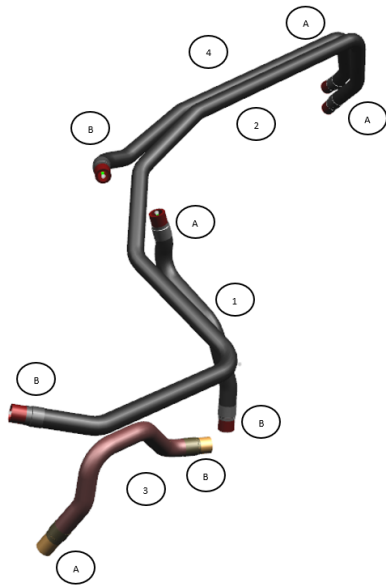

NOTE: Route all intercooler hoses very carefully. It is critical for intercooler performance that these hoses are not kinked once installed into the vehicle.

2. Locate QTY 2 Bracket – Intercooler Hose PT00048279 and QTY 2 BM6X100X20HF found in 1121-HWKDUAL. Install brackets as pictured below and torque fasteners to 10 Nm.

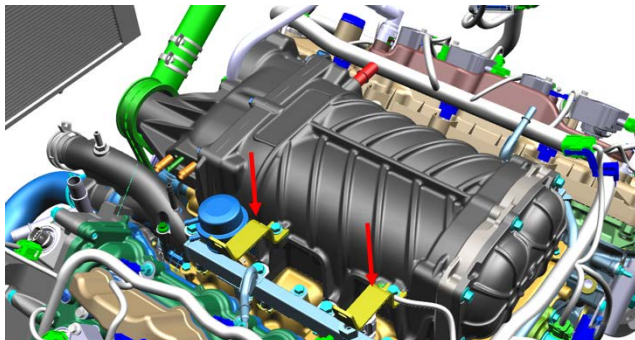

3. Locate PT00048097, intercooler reservoir hose. Connect end A of the intercooler reservoir hose to the intake manifold at the rear of the engine. Connect it to the upper port and secure with (1) 3/4" constant tension clamp (CT19X12-B0, found in 1121-HWKG).

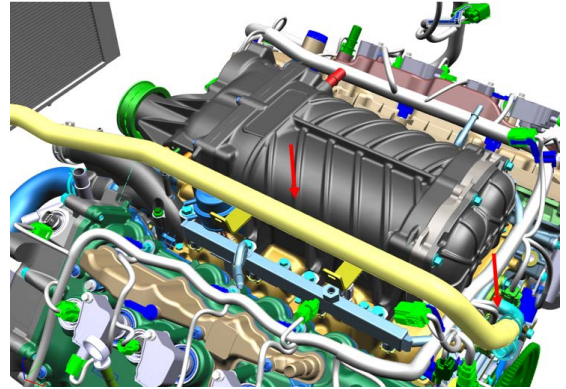

4. Connect side B of intercooler reservoir inlet hose to the side port of the degas bottle and secure with (1) 3/4" constant tension clamp (CT19X12-B0, found in 1121-HWKG).

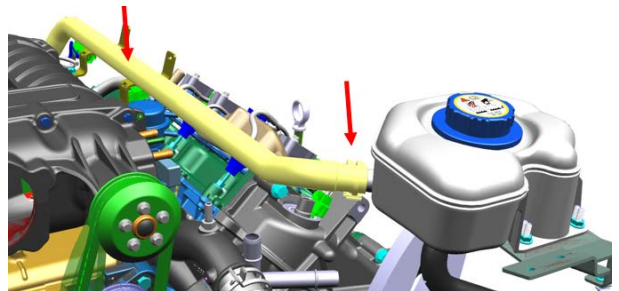

5. Locate LTR Outlet hose (PT00048098). Connect end A of the LTR outlet hose to the intake manifold port at the rear of the engine. Connect it to the lower port and secure with (1) 3/4" constant tension clamp (CT19X12-B0, found in 1121-HWKG). Hose end B will be installed with LTR install.

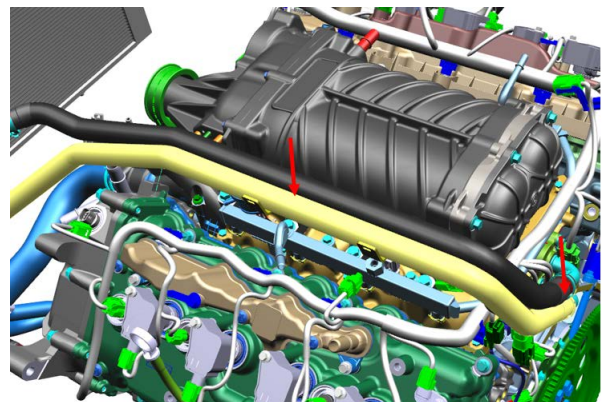

6. Locate intercooler pump inlet hose PT00048374. Connect end A to the degas bottle outlet port (bottom port of the degas bottle pictured) using one (1) 3/4" constant tension clamp (CT19X12-B0, found in 1121-HWKG).

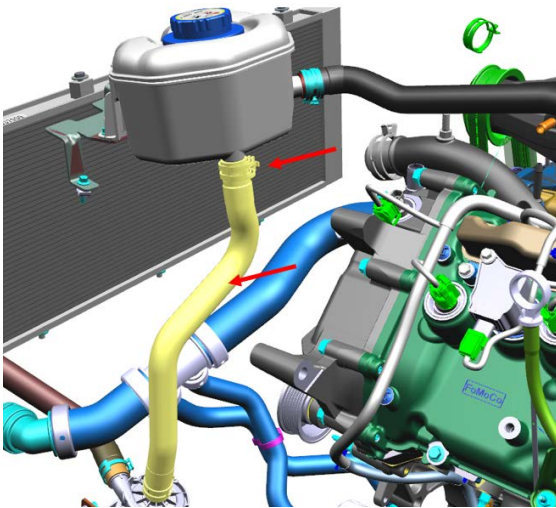

7. Connect hose end B of the intercooler pump inlet hose (PT00048374) to the inlet port of the intercooler pump using one (1) 3/4" constant tension clamp (CT19X12-B0, found in 1121-HWKG).

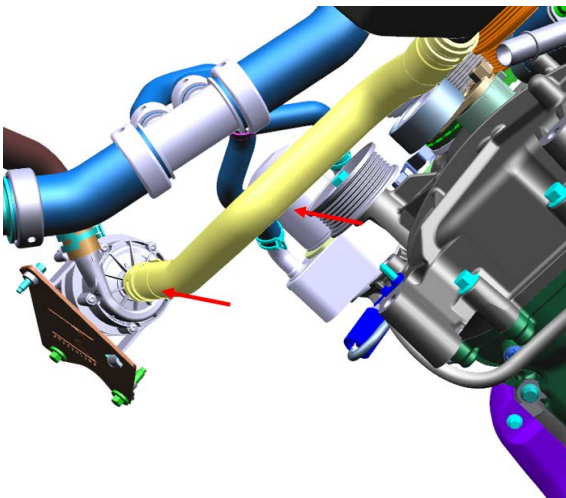

8. Connect the intercooler pump electrical jumper harness (PT00042003) to the pump. Then, using a zip tie, secure the harness to the hood latch cable.



8. Connect the intercooler pump electrical jumper harness (PT00042003) to the pump. Then, using a zip tie, secure the harness to the hood latch cable.



9. Return to page 48 and continue steps 7-14.

APPENDIX F – HYDROCARBON TRAP

1. Locate the stock airbox. Remove the Hydrocarbon Trap from the lid by either Drilling out / Cutting off the four corners of the plastic welds holding on the stock hydrocarbon trap. Note: Drill bit size 1/4" (Fraction) or 7 mm (Metric). BE CAREFUL TO NOT DRILL THRU THE HYDROCARBON TRAP.

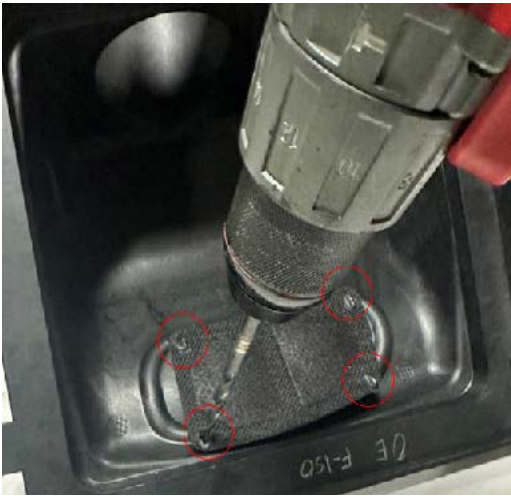

2. Carefully remove the hydrocarbon Trap from the stock Ford airbox lid.



3. Transfer this hydrocarbon trap onto the Roush airbox lid as shown. Make sure the four corners of the hydrocarbon trap align with the Roush airbox lid pins, push the hydrocarbon trap onto the Roush airbox lid.



4. Using one Round Push Nut (94800A816) found in the Air Induction Hardware kit and place one onto each of the four pins with prongs facing upwards.



5. Using an 8mm socket to push and secure the hydrocarbon trap onto the Roush airbox lid as shown.



6. Repeat steps 4-5 for the other 3 pins.
7. Make sure the hydrocarbon trap is secured in place as shown, test it by hand, it should be secure onto the Roush airbox lid.

