

## VW Adjustable Sway Bar End Links Product Information and Installation



Rugged, reliable, red and black. Our ECS Tuning Volkswagen adjustable sway bar end links are built for serious performance, built for looks, and built to last. A must-have for lowered suspensions or a perfect stock replacement; for street, track, or show, they're the only way to go!



Installation? No problem. Only a few basic tools are required and no matter how you stack it, each link is only held on at two points, the top and bottom, so it really doesn't get any easier. You'll have to work underneath the car, and the most important thing here is a good set of jack stands to safely support it. Aside from nuts vs. bolts, installation and adjustment procedures are same regardless of model. We'll cover product info, proper adjustment procedures, and installation tips, which will be all you need to successfully install and enjoy these new sway bar end links. As we said, this is pretty easy, and we're confident you'll have these on in no time and be ready show 'em off!

Thank you for purchasing our adjustable sway bar end links, we appreciate your business!

### This document has been broken up into several sections:

- 1) Product Overview [\(Page 2\)](#)
- 2) Adjustment [\(Page 6\)](#)
- 3) Installation Tips [\(Page 7\)](#)

**PRODUCT OVERVIEW**

MK4 Front Sway Bar End Links ([ES#3188106](#))

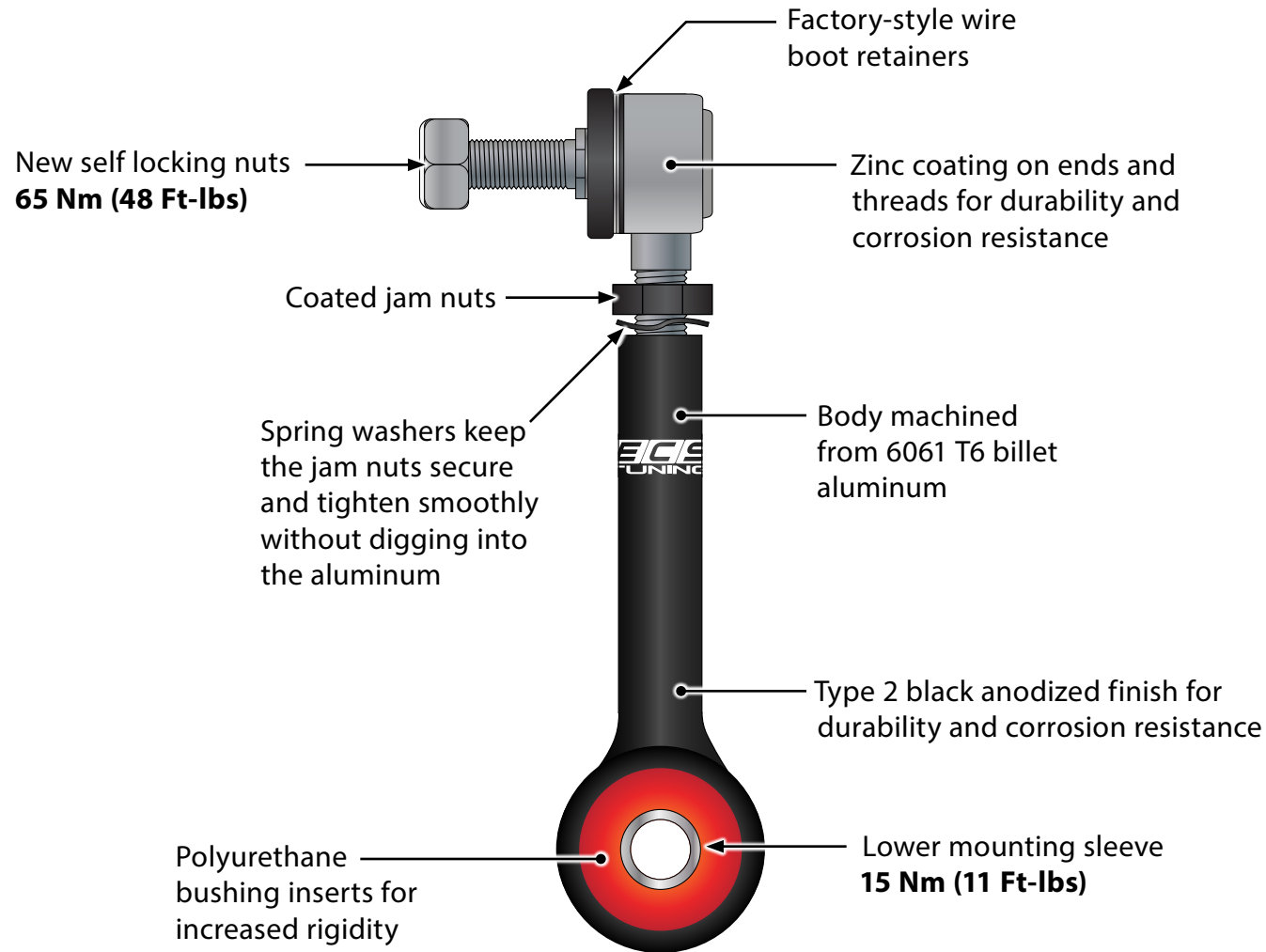

**PRODUCT OVERVIEW**

MK5, MK6, MK7 Front Sway Bar End Links ([ES#3184741](#))

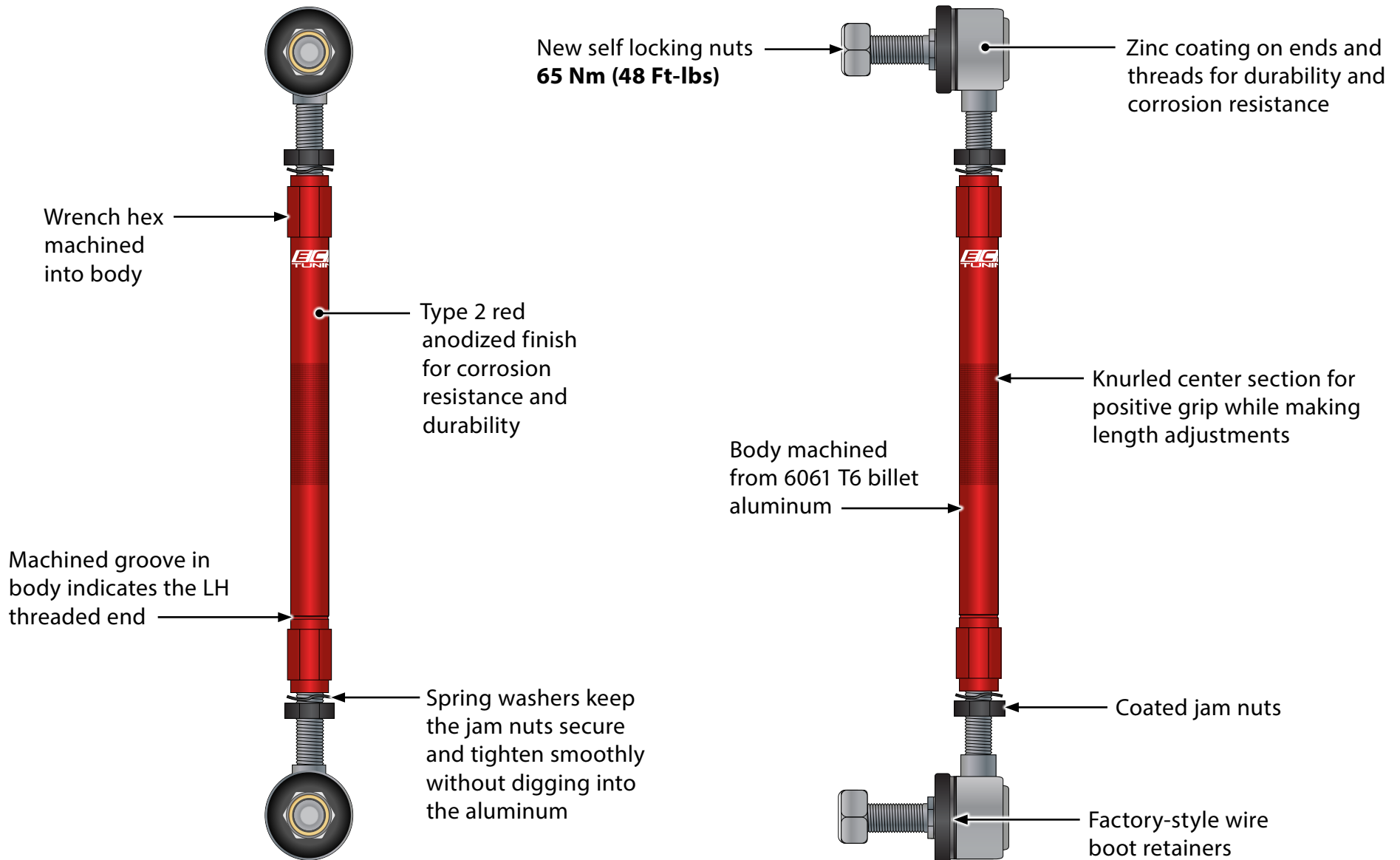

**PRODUCT OVERVIEW**

MK5, MK6 Rear Sway Bar End Links ([ES#3184747](#))

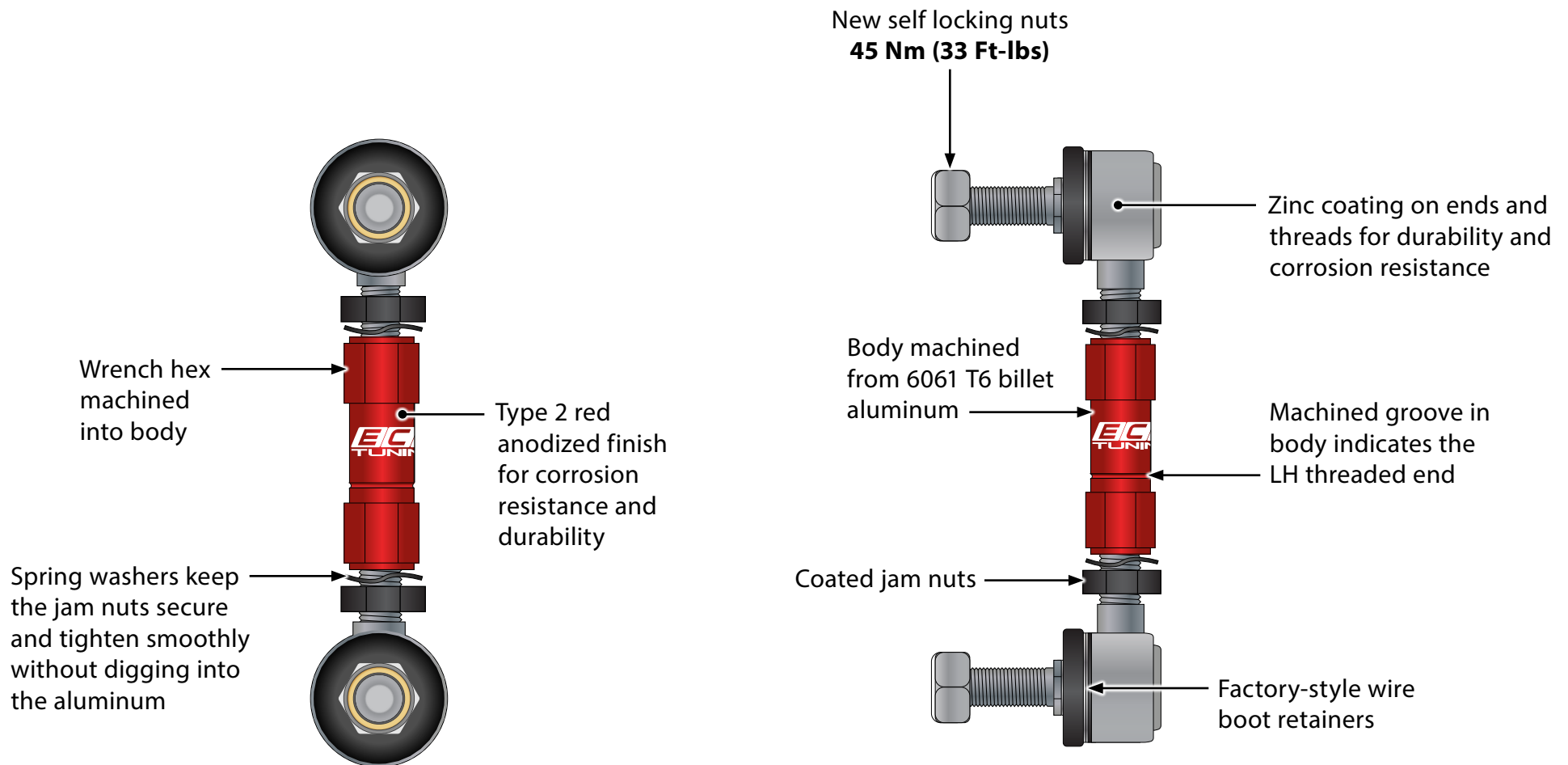

**PRODUCT OVERVIEW**

MK7 Rear Sway Bar End Links ([ES#3514622](#))

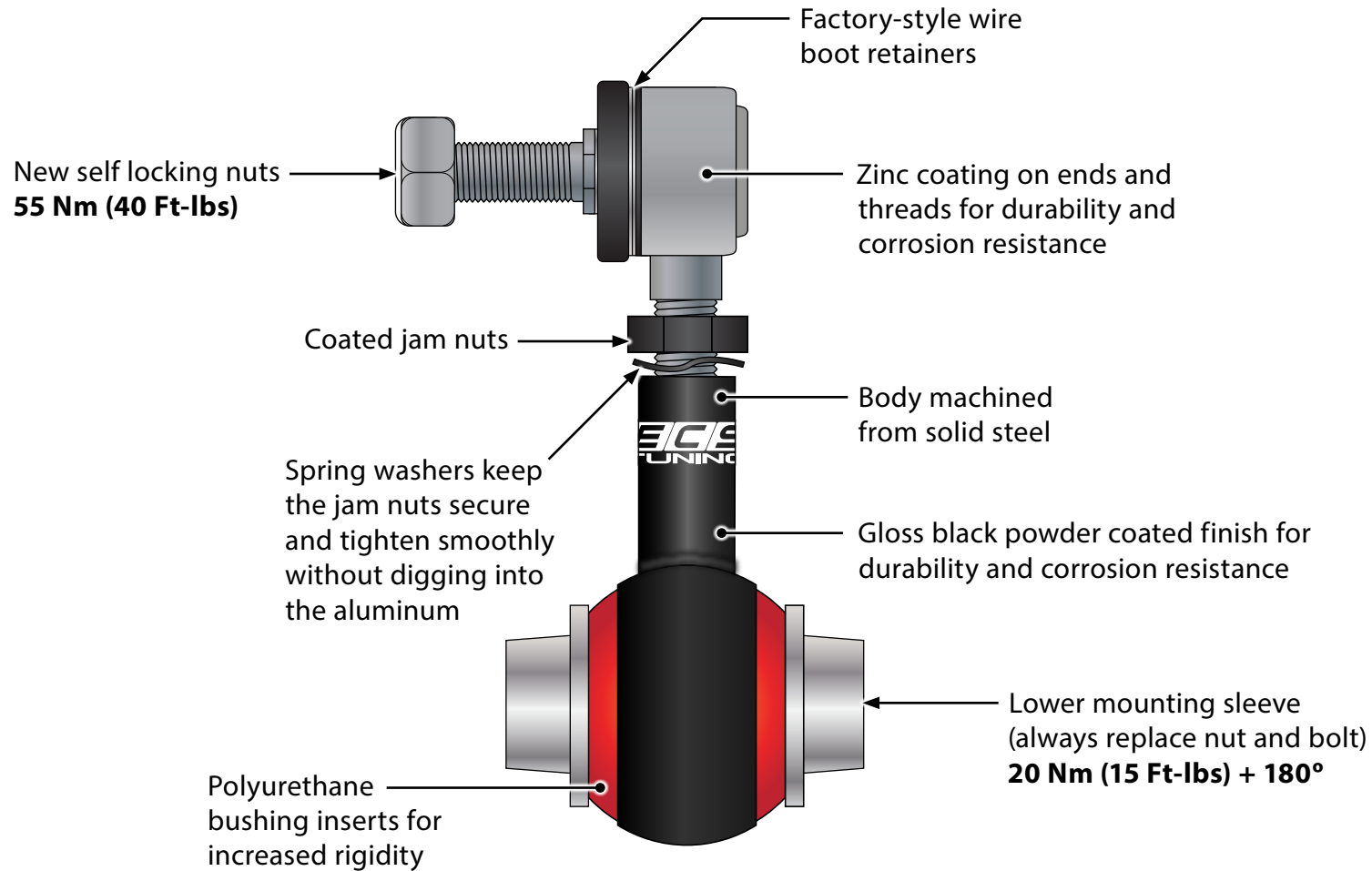

## ADJUSTMENT

You might ask why we start with sway bar end link adjustment before installation. Understanding it will allow you to plan your installation strategy, and save you a little bit of time. Adjustment is easy, and knowing the reason for it explains the adjustment in itself. Changes in ride height resulting from lowering springs and coil over suspensions will quite often alter the required center-to-center distance between the upper and lower mounting points of an end link. Installing a link of original length in this situation can apply a preload to the sway bar, or position it too close to another suspension component, which will have an adverse affect on suspension and handling. The goal is to adjust the end link so with the sway bar centered in its range of travel, the link is installed in a perfectly neutral position, applying no preload.

### A good strategy for sway bar end link installation and adjustment is:

1. Remove the original sway bar end links.
2. Load the suspension so it is at ride height. This is, of course, easily done with the wheels on and the car on the ground, but there's one problem, you can no longer get to the sway bar end links. Instead, use one of the following methods:
  - Drive-on lift method: This is the easiest method because with the wheels on, you can work under the car to install and adjust the end links.
  - Jack method: Jack up the suspension just until the spring begins to lift the car, indicating ride height, then adjust the end links. Keep in mind this must be done with the wheels off and the vehicle still supported by jack stands.
  - Wheel stand method: With the wheels on, wheels stands such as our Schwaben [ES#2748976](#) or [ES#2748979](#) will work just like a drive on lift.
3. With the suspension at ride height, center the sway bar in its range of travel, then adjust the length of the sway bar end links so they "slip" easily into place. This indicates a perfect neutral position.
4. Install and torque all of the fasteners while the vehicle remains at ride height, and you have achieved a perfect adjustment in the process of installation.

Advanced adjustment procedures? Yes, they do exist. You may have heard someone mention preload on a sway bar. We're not going to cover these type of adjustments, but we'll wet your appetite a little. These are primarily for specific types of performance and racing, and can differ for each one. Even the smallest amount of preload can affect the way your suspension reacts during cornering and acceleration. So for drag racing, circle tracks, or road courses, you can benefit considerably from these types of adjustments.

Corner Balancing: This is the ultimate type of sway bar end link adjustment for street and road courses. With this type of adjustment, the car is weighted with the driver and placed on a special scale to measure the actual ground pressure at each wheel. The sway bar end links are then adjusted to match the pressures. Without this special equipment, the neutral position is the best installation procedure.

## INSTALLATION TIPS

Sway bar end link installation is a very simple procedure. Each link, regardless of end style, is secured on at the top and bottom. You just have to unbolt and remove the old ones, then install the new ones in their place.

What tools do you need? Sizes will vary depending on your car, but here's what you'll need:

- Hydraulic Jack and Jack Stands
- Open/Boxed end Wrenches
- Lug Nut Socket
- Sockets/Ratchet
- Pry Bar
- Torque Wrench
- Allen (Hex Bit)/Torx Sockets

Here are a few tips and tricks for installation, and don't forget, proper adjustment is very important.

- You must safely raise and support the vehicle for access to the sway bar end links.
- In some cases, it may be easier to remove the wheels.
- When removing stud mounted ends, the entire stud may spin. To counter-hold the stud, originals will have either a hex at the base of the stud or an Allen/Torx recess in the end.
- When installing new stud mounted ends, there is a hex at the base of the stud that you can hold with a wrench to prevent it from spinning.
- Be sure to use the listed torque specifications and view page 8 for torquing tips.
- After performing the adjustment, add a few drops of blue threadlocker ([ES2710718](#)) to the threads and securely tighten the jam nuts.
- When both ends of the end link are threaded, there is a LH and RH thread. What this means is that by rotating the body of the link, both ends will either extend or retract the same distance at the same time, depending on the direction of rotation.

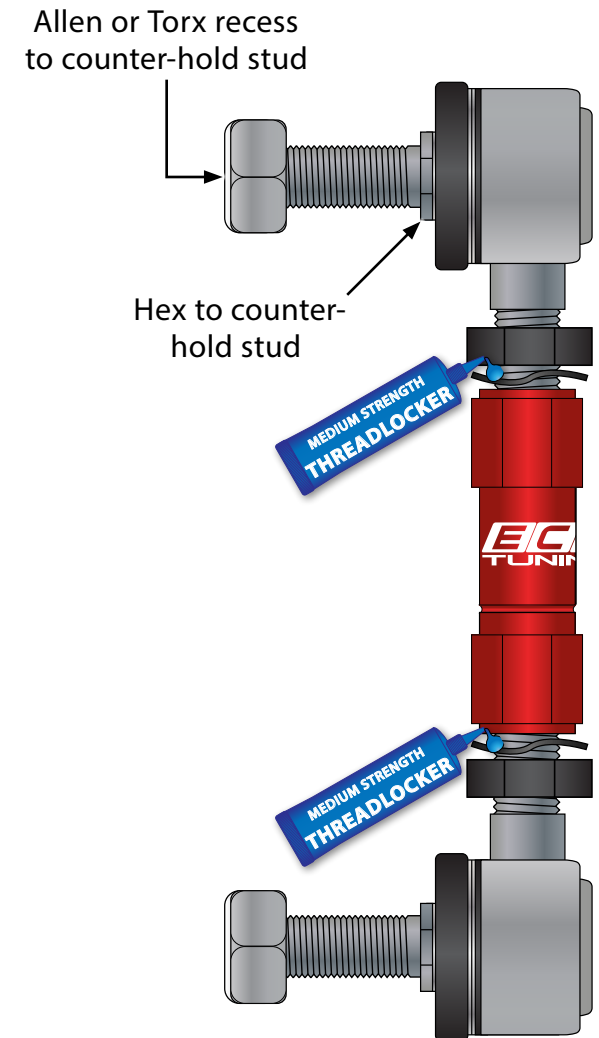

**TORQUING TIPS**

**Torque to Yield or “Stretch” Bolts**

Many bolts will have a torque specification listed in the format - xx Nm (xx Ft-lbs) + xx degrees. These bolts are torque to yield bolts, commonly referred to as “stretch” bolts. The correct procedure for torquing these bolts is:

**Stage One** - Torque the bolt(s) to the initial Nm or Ft-lb specification. If there is more than one, be sure to torque them in the correct sequence.

**Stage Two** - Tighten or “stretch” the bolt(s) the additional specified number of degrees. If there is more than one, be sure to follow the correct sequence.

**Note** - Some bolts may have two or more stages of torquing before the final stage of “stretching” the bolts.

When tightening more than one bolt in a specified sequence, be sure to mark each fastener with paint **immediately** after performing the final stage or “stretching” of the bolts. This will ensure that you keep track of which bolts have already been “stretched”.

All Torque to Yield bolts should only be used once and should be replaced each time they are removed. If they are reused, they will not be able to achieve the proper clamping force with the specified torque.

**Lubrication**

Torque specifications are always listed for a dry fastener (**no** lubrication) unless specified otherwise.

Some fasteners require lubrication on the threads -or- on the contact surface while torquing. These fasteners will be listed with the specific location and type of lubrication required. Always follow manufacturers recommendations exactly.

Lubricating a fastener that is intended to be installed dry and then torquing it to factory specifications will increase the clamping force and stress on the fastener and components, which can result in damage or failure.

Do not lubricate the threads of any fastener unless it is specifically recommended by the manufacturer.

**Ribbed vs. Non-Ribbed Bolts**

Ribbed and Non-Ribbed bolts in the same location generally require a different torque specification.

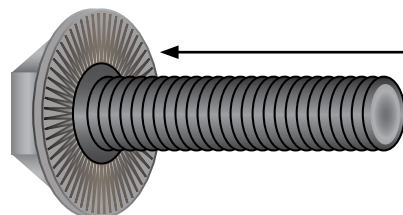

A ribbed bolt is identified by the ribs on the contact surface

A non-ribbed bolt is identified by the smooth contact surface

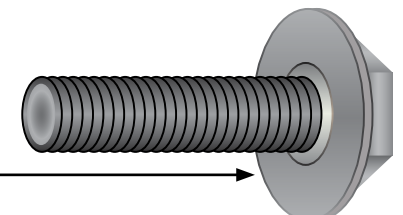



## Your Adjustable Sway Bar End Link installation is complete!



### **These instructions are provided as a courtesy by ECS Tuning**

Proper service and repair procedures are vital to the safe, reliable operation of all motor vehicles as well as the personal safety of those performing the repairs. Standard safety procedures and precautions (including use of safety goggles and proper tools and equipment) should be followed at all times to eliminate the possibility of personal injury or improper service which could damage the vehicle or compromise its safety.

Although this material has been prepared with the intent to provide reliable information, no warranty (express or implied) is made as to its accuracy or completeness. Neither is any liability assumed for loss or damage resulting from reliance on this material. SPECIFICALLY, NO WARRANTY OF MERCHANTABILITY, FITNESS FOR A PARTICULAR PURPOSE OR ANY OTHER WARRANTY IS MADE OR TO BE IMPLIED WITH RESPECT TO THIS MATERIAL. In no event will ECS Tuning, Incorporated or its affiliates be liable for any damages, direct or indirect, consequential or compensatory, arising out of the use of this material.