

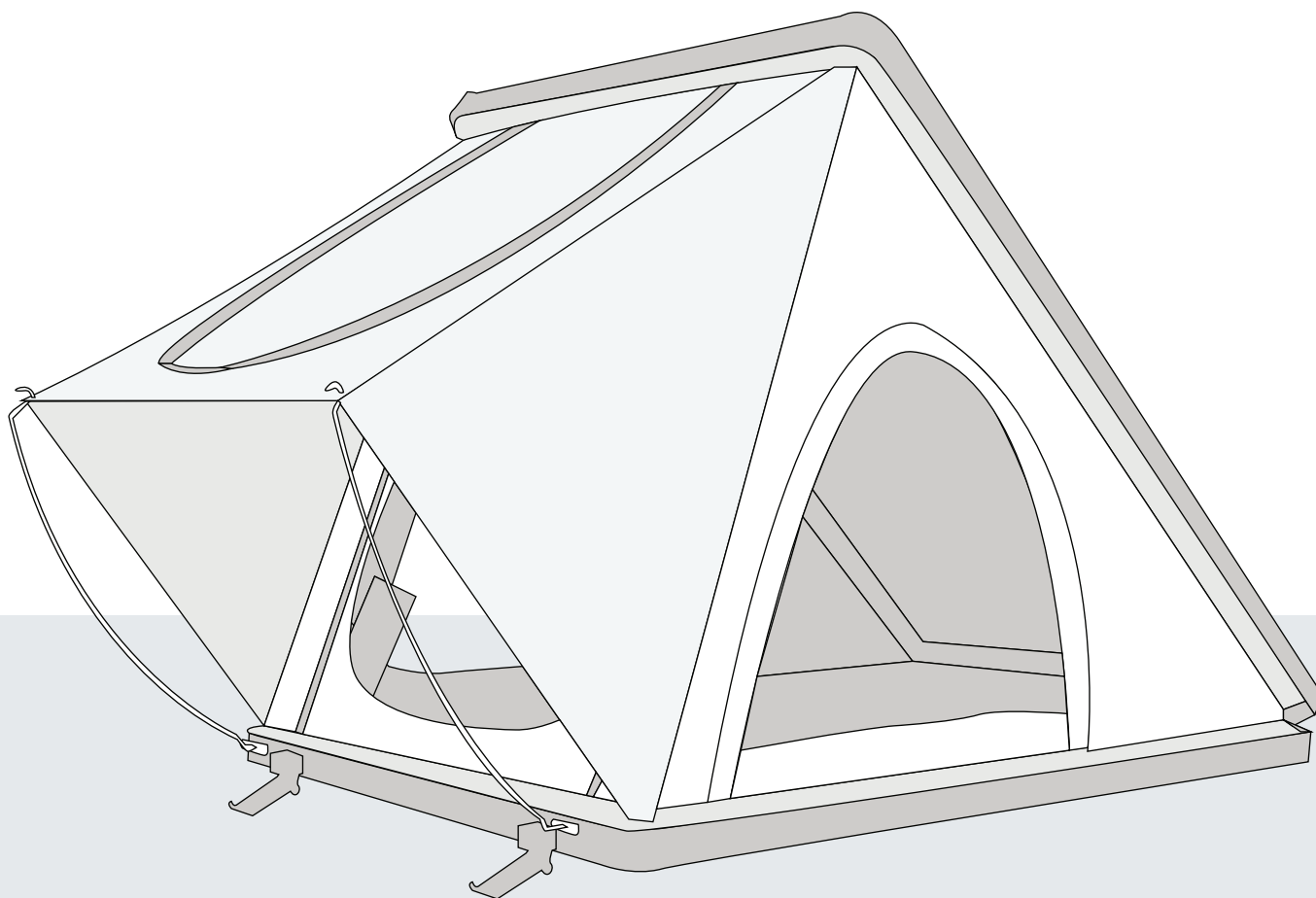

## HD Sidewinder Roof Top Tent



**CAREFULLY READ INSTRUCTIONS  
PRIOR TO THE FIRST USE OF THE  
HD SIDEWINDER ROOF TOP TENT**

## GET TO KNOW YOUR SIDEWINDER RTT

We recommend you check all parts are included prior to first use.

### COMPONENTS NEEDED

1x Internal Bungee Strap  
2x Ladder Support Bracket  
2x Window Row Bracket  
1x Lid Handle  
2x Lid Latch Key  
8x Extrusion Plastic End Cap and Screws

4x Mounting Plate  
4x Roof Bar Mounting Eyelets  
24x Flat Washers  
4x Roof Bar Mounting Brackets  
2x Roof Bar  
8x m8 x 1.25 14mm Long Bolt  
24x m8 Nylon Lock Nut

1x Ladder  
2x Awning Stay  
1x Spanner  
8x Tapping Screw

## GETTING STARTED

1

Find a flat area to work & open the carton. This will provide a clean surface to work on whilst tent is being set up. Check that all components are supplied.

## ASSEMBLY OF COMPONENTS

2

### TENT LIFT HANDLE

This handle is located in the top section of the tent at the opposite end to the hinges, insert the assembled handle into the channel of the top section, center and tighten.

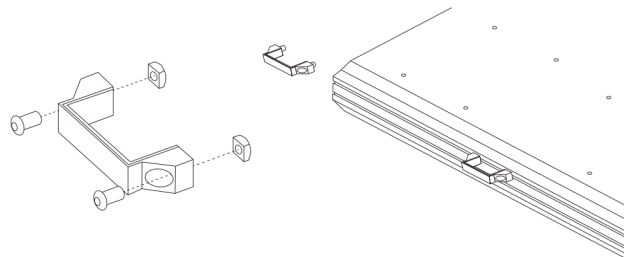

### LADDER SUPPORTS

Identify the required entry point to the tent as this will determine the position of the ladder brackets. Position the ladder brackets approx. 430mm apart in the center of the desired entry point.

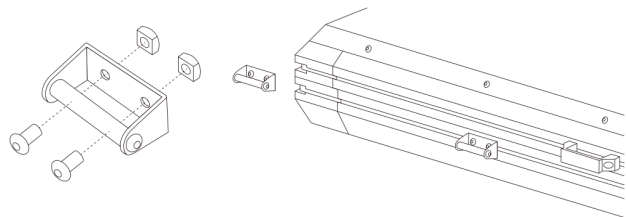

Tip: Temporary remove the horizontal bar on the ladder bracket to better access the hex bolts

3

### AWNING LIFT HANDLE

Locate these at the rear of the tent on the bottom section & position 70mm in from the edge and ensures the extended tabs are facing toward the outside edge of the tent

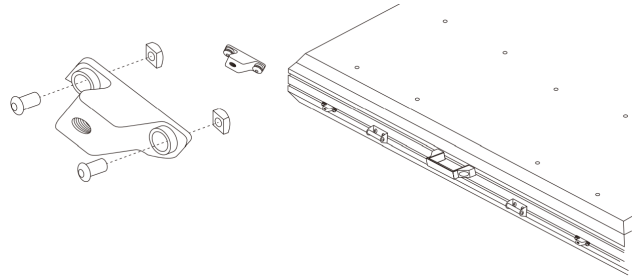

### ROOF BARS

The tent is supplied with two (2) roof bars that are fitted to the side channels on the roof lid.

Slide the heads of 2 x 20mm M8 bolts into the channel of the roof lid near desired location. Locate the holes on the bottom of the bracket (long side) and place over the bolts. Fit washer and Nylock nut and leave loose. Repeat for opposite side.

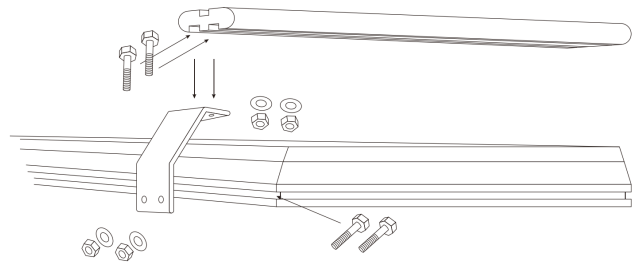

Slide the 20mm M8 bolts in the two channels on the underside of the roof bar and then attach to the side brackets, loosely attach the Washer & Nylock nuts.

Once the rails are in correct location tighten all fixings, locate the Mounting Eyelets and tighten then fit the plastic end caps.

4

Before lifting the tent to the roof of the car, slide a M8x55mm bolt into each channel on the base mounting rails.

1. Using a minimum of 2 people, lift the roof top tent to the roof of the car and locate in the desired position, ensuring that a bolt is on either side of the roof rails.

2. Locate the Mounting Plate over the bolts and secure with the washers & Nylock nuts, repeat on the 3 remaining mounting points.

3. Check that the tent is in the correct position before tightening the fittings and inserting the plastic end caps into the mounting rails.

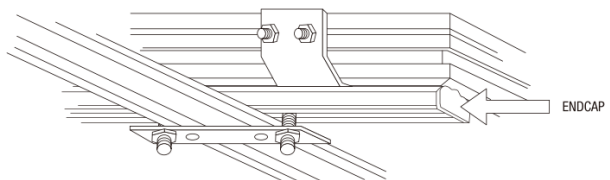
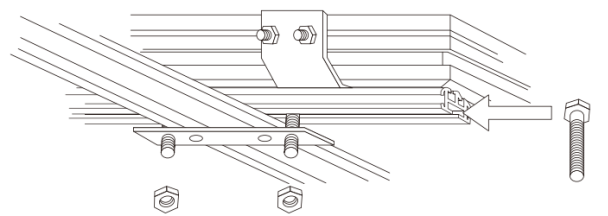

# HD Sidewinder Roof Top Tent

18109901 HD Sidewinder - Aluminum Roof Top Tent

## SET-UP & CARE INSTRUCTIONS

Continued

4

- **Avoid storing your tent wet. If conditions dictate that you do, open, and dry out as soon as possible to avoid moisture damage.**
- **The overall height of your vehicle is increased when driving with your roof top tent.**
- **The center of gravity is altered when the rooftop tent is fitted to your vehicle. Adjust your driving to accommodate this change.**

**Your Roof Top Tent is located so it will open to the rear of the vehicle.**

The minimum spacing between the roof rails is to be 47.24 inches to ensure that the tent is supported correctly, the weight is evenly distributed

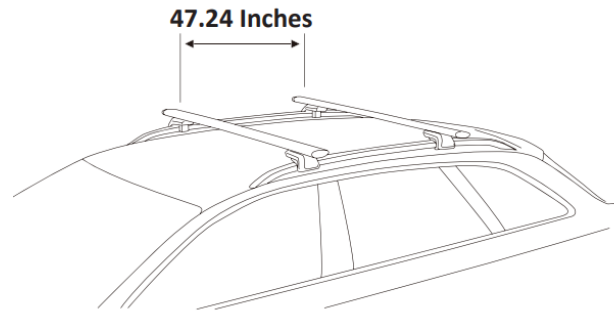

5

**Release the locks on either side of the tent & climb the ladder, lift the lid with the handle until the gas struts take over. Once open, lower the shock cord that is used to secure the canvas when packing away and locate in both corners of the base.**

**Locate the flexible awning stays into the mounts on the front edge of the tent base, flex these and locate in the eyelets on the awning, unzip entry door and enter the roof top tent.**

**Locate the safety pole on the left-hand side (beside the mattress) and extend to the roof and twist to lock in position - It is recommended that the safety pole is always in position when using the tent.**

**Remove the bungee strap that is positioned across the inside of the tent before being used.**

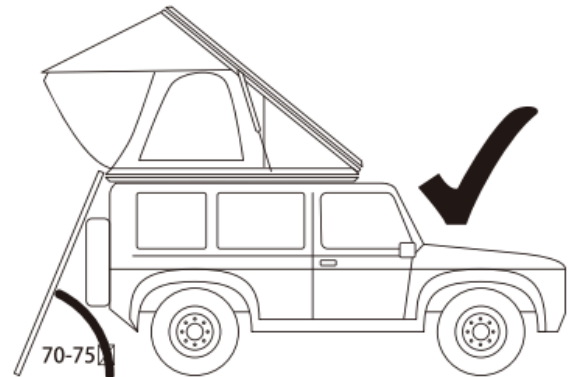

Once the tent is fixed securely to the vehicle's roof rack and the vehicle is positioned with the hand brake applied, attach the ladder, and ensure that it is secure and is locked in position and on an angle of 70 to 75 degrees.

# HD Sidewinder Roof Top Tent

## SET-UP & CARE INSTRUCTIONS

FEBRUARY 2024

### CLEANING

1. Open the tent fully and brush / vacuum inside.
2. Clean the fabric as needed using a mild detergent, warm water, and a soft to medium brush. Rinse fabric of all detergent prior to drying.
3. Dry tent in the sun with all windows open. The tent must be completely dry before storage, or mildew and mold may occur. This is especially necessary after camping in rain or wet conditions.
4. Using a small brush, remove dirt from zippers. Use a silicon spray to keep zippers lubricated.
5. Using a small brush, remove dirt from zippers. Use a silicon spray to keep zippers lubricated.
6. Wash mattress pad and hang dry

### CLOSING & STORING

- It is possible to leave sleeping bags and pillows on the mattress if laid flat, however these may need to be removed if it is difficult to close the tent, as this may put excessive pressure on hinges and latches that may cause failures or damage to the tent.
- Re-attach the bungee strap to the locating points with "O" rings sewn to the internal wall of the tent, it is recommended that the side windows are left partially open to allow any trapped air to escape when the top is being closed.
- Release and store the safety pole, exit the tent, and detach the flexible awning stays and store.
- Return the external shock cord to the center of the fabric to allow the canvas to be pulled toward the center of the tent.
- Using the storage strap, pull the lid in a downwards direction, as the lid is being pulled down check that the canvas is tucked in and is not trapped between the rubber seal around the edge of the tent body, secure the strap and excess fabric and lock the latches then store the ladder.

## WARNINGS

- **THE SIDEWINDER ROOF TOP TENT HAS BEEN DESIGNED FOR GENERAL CAMPING USE UNDER NORMAL CONDITIONS.**
- **TO AVOID CHANCES OF PERSONAL INJURY AND PROPERTY DAMAGE, WE HIGHLY RECOMMEND THE SIDEWINDER ROOF TOP TENT SHOULD NOT BE ERECTED DURING WINDY CONDITIONS AS PERSONAL INJURY AND OR PROPERTY DAMAGE MAY OCCUR.**
- **DO NOT CUT OR MODIFY THE TENT OR MOUNTING ACCESSORIES.**
- **DO NOT EXCEED THE VEHICLE MANUFACTURER'S WEIGHT LIMITS.**
- **DO NOT USE DAMAGED OR EXCESSIVELY WORN PRODUCTS. CONTACT US IF YOU ARE UNSURE.**
- **KEEP ALL FLAMES AND HEAT SOURCES AWAY FROM THE FABRIC**
- **UNDER NO CIRCUMSTANCES SHOULD ANY NAKED FLAME SOURCES BE USED NEAR THE TENT, KEEP FIRES AWAY FROM THE TENT**
- **KEEP A LOOK OUT FOR ANY AIRBORNE BURNING EMBERS THAT MAY COME IN CONTACT WITH THE TENT. KEEP A FIRE EXTINGUISHER OR BUCKET OF WATER NEAR BY.**
- **DO NOT OPERATE ANY DEVICES WHICH BURN FUEL INSIDE THE TENT WHILE THE WALLS ARE ATTACHED.**
- **KEEP EXITS CLEAR**
- **KEEP AN EYE OUT FOR CHILDREN WHEN TENT IS IN USE**
- **STOW AWAY TENT BEFORE OPERATING VEHICLE**



## DO YOU NEED OUR HELP?



**CUSTOMER SUPPORT 833-226-4863**



**SALES@OVERLANDVEHICLESYSTEMS.COM**

**WANT TO SHOW US YOUR RIG?  
CHECK OUT OUR SOCIAL!**

**@overlandvehiclesystems**

