

# TRAX 4™ INSTRUCTION SHEET

Installation Sheet-928

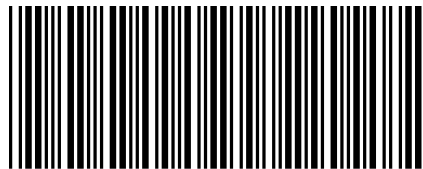

\*00928-IS\*



1444 Fortress Street, Chico CA 95973 • (800) 442-0056 / (530) 893-5209 • Fax (530) 893-0204

[www.TransferFlow.com](http://www.TransferFlow.com)



# ATTENTION!

**TRAX 4™ auxiliary tanks must be programmed via the TRAX 4™ mobile app. for the TRAX 4™ system to operate.**

**Please see the TRAX 4™ Owner's Manual for instructions on how to:**

- Download the TRAX 4™ mobile app.
- Connect your phone/TRAX 4™ mobile app to your truck's Bluetooth.
- Set up the TRAX 4™ mobile app to work with your TRAX 4™ auxiliary system.

Scan the QR code below with the camera on your mobile device to access the TRAX 4™ set-up video.



**SCAN ME**

**ANDROID**



**SCAN ME**

**iPhone**



1444 Fortress Street, Chico CA 95973 • (800) 442-0056 / (530) 893-5209 • Fax (530) 893-0204

[www.TransferFlow.com](http://www.TransferFlow.com)

# FOREWORD

Thank you for purchasing a Transfer Flow fuel tank system for your truck. Please read the following procedures carefully before starting the installation.

This manual provides the necessary information for the installation of the Transfer Flow fuel system onto your vehicle. All the information and instructions contained in this document are based on our annual model year signoff. We update our instruction sheets based on information obtained during this model year signoff and information provided by OEM companies and our customers. Changes to installation instructions may be made at any time without notice. If you find something we missed or require any additional information, please feel free to contact our Technical Support team at (800) 442-0056 x2.

Transfer Flow fuel systems and parts are intended to be used in conjunction with original manufacturer's equipment or Transfer Flow systems and components.

Our systems and components are not intended to be used in conjunction with other aftermarket fuel systems. Attempting to use our products inappropriately may lead to malfunction and voids the warranty.

## Supplemental Instruction:

Make	Year	Instruction Sheet Number
All	All	484, 642 & 636
Ram	2011 – 2020 Short Bed	929
Ram	All	930



1444 Fortress Street, Chico CA 95973 • (800) 442-0056 / (530) 893-5209 • Fax (530) 893-0204  
www.TransferFlow.com

# TABLE OF CONTENTS

**FOREWORD**..... 2

**NOTICE**..... 5

**SAFETY NOTES**..... 6

**TOOLS & SUPPLIES REQUIREMENTS**..... 7

**PARTS LIST/DIAGRAM** ..... 8

**INSTALLATION INSTRUCTIONS** ..... 9

    SECTION 1: PREPARING THE VEHICLE ..... 9

    SECTION 2: PREPARING THE AUXILIARY TANK ..... 10

    SECTION 3: MOUNT THE TANK ..... 13

    SECTION 4: PLUMBING THE SYSTEM ..... 16

    SECTION 5: WIRING THE SYSTEM ..... 18

**TRAX4™ Mobile App Set Up**.....See Owner's Manual

**APPENDIX: TRAX 4™ Wire Harness Detail** ..... 27

TM



1444 Fortress Street, Chico CA 95973 • (800) 442-0056 / (530) 893-5209 • Fax (530) 893-0204  
[www.TransferFlow.com](http://www.TransferFlow.com)

# NOTICE

**This product is protected by state common law, copyright and/or patent. All legal rights therein are reserved. The design, layout, dimensions, geometry, and engineering features shown in this product are the exclusive property of Transfer Flow. This product may not be copied or duplicated in whole or part, abstractly or fundamentally, intentionally, or fortuitously, nor shall any design, dimension, or other information be incorporated into any product or apparatus without prior written consent of Transfer Flow.**

**Transfer Flow fuel systems and parts are intended to be used in conjunction with original manufacturer's equipment or Transfer Flow systems and components.**

**Our systems and components are not intended to be used in conjunction with other aftermarket systems. Attempting to use our products inappropriately may lead to malfunction and voids the warranty. To ensure that your transfer flow products perform appropriately for many years to come, we ask that you follow these guidelines.**



1444 Fortress Street, Chico CA 95973 • (800) 442-0056 / (530) 893-5209 • Fax (530) 893-0204  
[www.TransferFlow.com](http://www.TransferFlow.com)

# SAFETY NOTES

Please read installation instructions before beginning the installation of the Transfer Flow fuel system.

If you would prefer your fuel system be professionally installed, please contact your local dealer or you can browse our list of dealers in your area on our website at [www.TransferFlow.com/installation](http://www.TransferFlow.com/installation).

Transfer Flow fuel systems are designed for use on stock OEM vehicles. We do our best to foresee how our customers will use and modify their vehicles, but unfortunately, we cannot verify all aftermarket modifications. If your vehicle has had any modifications to the chassis, suspension, fuel system, truck bed, or wheel/tire size is different than stock, please call Transfer Flow before installing one of our fuel systems.

- Work in a well-ventilated area.
- Always wear safety glasses.
- The Transfer Flow tank is heavy, please use proper lifting techniques when handling tank.



**CAUTION: DO NOT HAVE ANY OPEN FLAME OR HEAT SOURCE CLOSE TO THE INSTALLATION AREA.**



**CAUTION: DO NOT OVER FILL.**

**PLEASE READ THE FOLLOWING PROCEDURES CAREFULLY BEFORE STARTING THE INSTALLATION.**



1444 Fortress Street, Chico CA 95973 • (800) 442-0056 / (530) 893-5209 • Fax (530) 893-0204  
[www.TransferFlow.com](http://www.TransferFlow.com)

# TOOLS & SUPPLIES REQUIREMENTS

Before starting the installation process, review the entire installation instructions. If you have any questions regarding the fuel system or the installation process, please contact Transfer Flow at (800) 442-0056.

## Tool List:

- Sharpie®
- Long 1/8" drill bit
- 5/32" drill bit
- 1/2" Drill Bit
- 9/16" Drill Bit
- 5/8" Drill Bit
- 1 1/4" Hole Saw
- Diagonal Cutters
- 7mm Socket
- 8mm Socket
- Digital Multimeter
- Hose Cutters
- Sandpaper
- 3/4" Socket
- 0-50 ft/lb. Torque Wrench
- Ratchets to fit above sockets
- Extensions
- Telescoping Magnetic Pickup Tool

00928-IS



1444 Fortress Street, Chico CA 95973 • (800) 442-0056 / (530) 893-5209 • Fax (530) 893-0204  
www.TransferFlow.com

02/07/2022

REV D

# PARTS LIST/DIAGRAM

Before beginning installation, verify all parts listed below are included in the installation kit. If there are any missing or damaged parts, please contact Transfer Flow at (800) 442-0056.



*NOTE: Fuel system shown above is Transfer Flow's 50-gallon in-bed auxiliary fuel tank system. Your tank's appearance and parts shown may vary.*

## Parts List:

- Installation Sheet (IS-928 and 930)
- TRAX 4™ Computer with Module Kit (020-01-17098)
- Auxiliary Fuel Tank
- Fuel System Install Kit



1444 Fortress Street, Chico CA 95973 • (800) 442-0056 / (530) 893-5209 • Fax (530) 893-0204  
www.TransferFlow.com



# INSTALLATION INSTRUCTIONS

## **SECTION 1: Preparing the Vehicle**

1. Key the ignition off.
2. Empty the bed of any movable objects.
3. Extinguish any heat sources in the area.
4. You will have one of the following different foot positions for mounting.
  - Feet are on the front and back sides of the 40-gallon in-bed fuel tanks, 40 gallon and 70-gallon fuel tank and tool box combo.



**Figure 1. Front and rear foot option.**



1444 Fortress Street, Chico CA 95973 • (800) 442-0056 / (530) 893-5209 • Fax (530) 893-0204  
www.TransferFlow.com

- Feet are on the front and side of the 37-gallon, 50-gallon, 75-gallon, and 100-gallon in-bed fuel tank.

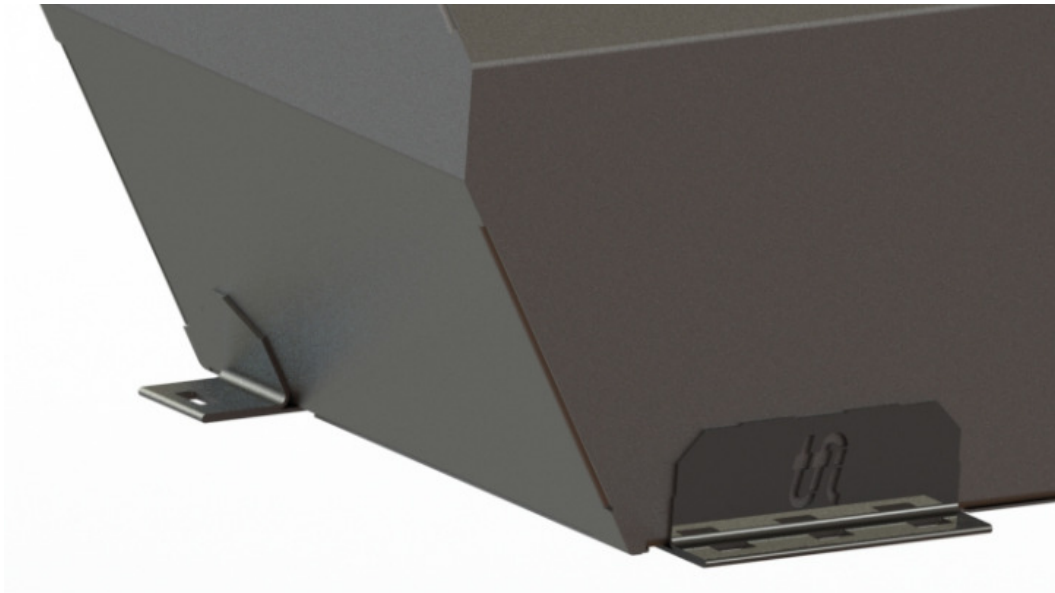

Figure 2. Front and side mounted feet.

## **SECTION 2: Preparing the Auxiliary Tank**

5. Using a digital multi meter, measure the resistance signal at the auxiliary sending unit. Attach the leads to the sending unit ground and signal (pictured below). With the tank resting on level ground, positioned as if it were in the vehicle at empty, the resistance reading should match the table below **+/- 3 Ω**. Turn the tank upside down so the float arm will fall into the full position. The resistance should read between 262-272 ohms. If any of these readings are outside of the aforementioned specs call technical support.

Tank Gallons / type	Resistance
37 cross bed	30 Ω
40 tool box	41 Ω
40 cross bed	30 Ω
50 tool box	23 Ω
50 cross bed	34 Ω
70 tool box	31 Ω
75 cross bed	37 Ω
100 cross bed	37 Ω

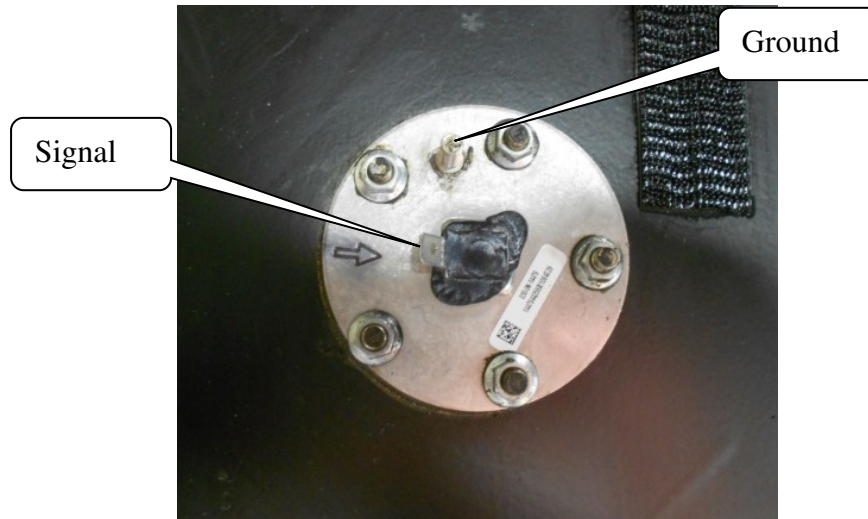

1444 Fortress Street, Chico CA 95973 • (800) 442-0056 / (530) 893-5209 • Fax (530) 893-0204  
www.TransferFlow.com

**Table 1: Resistance Guide****Figure 3. TRAX 4™ sending unit.**

### Pre-Position the Tank in the Bed of the Truck

6. Place the tank in the bed of the truck. The tank should be spaced about 1” away from the head gate and centered between the bed rails. If you are installing a tool box tank make sure there is ample room to open the lid. In all cases the fill opening should be on the driver’s side.
7. Mark the mounting holes with a Sharpie® or paint pen. If you cannot reach the mounting tabs near the cab, attach a Sharpie® or paint pen to a long stick with some electrical tape.

**Figure 4. Sharpie® attached to an extension for hard-to-reach areas.**

8. Remove the tank from the mounting area.
9. Measure the mounting hole locations using the head gate and bed corrugations as reference lines.
10. Crawl under the truck.
11. Measure and mark the bed mounting holes on the bottom side of the bed. Use the head gate and bed corrugations for reference.



1444 Fortress Street, Chico CA 95973 • (800) 442-0056 / (530) 893-5209 • Fax (530) 893-0204  
[www.TransferFlow.com](http://www.TransferFlow.com)

12. Make sure the bolts have clearance and will not interfere or damage any surrounding hoses or electrical.

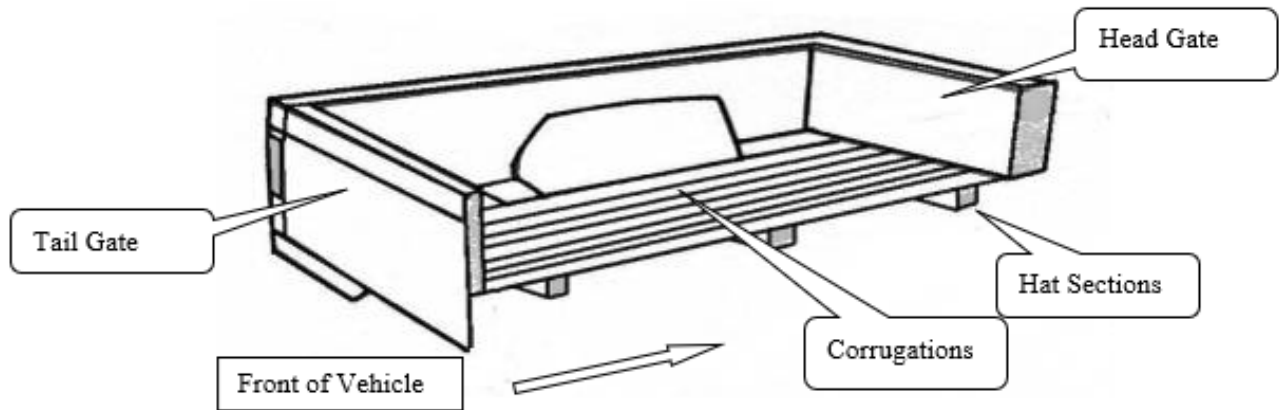

**Figure 5:** This cutaway drawing shows the head gate and bed corrugations.

13. Look at the marks you have created and make sure that a 1/2" bolt with the provided large shims will fit in the area you have marked. It is OK to drill through the hat section of the bed, but do not drill through the tall edge of the hat section. Make sure that your drilled hole will pierce through the flat area of the hat section.

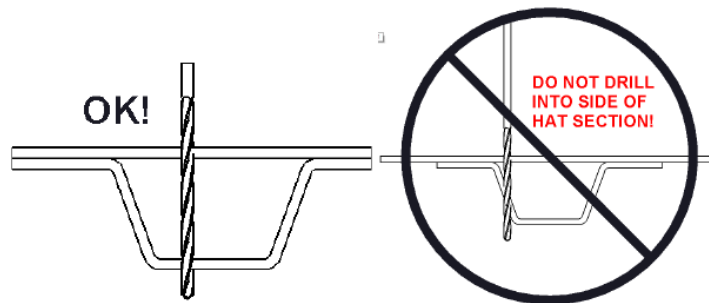

**Figure 6.** The hat sections in the bed and where you can drill.

14. Move any wires, hoses or obstructions that may be scarred or damaged by a drill bit.

15. If you have any doubts of tank location, double check your measurements and reposition tank if needed. If you move the tank you will need to remark the holes on the underside and double check your measurements once again.



1444 Fortress Street, Chico CA 95973 • (800) 442-0056 / (530) 893-5209 • Fax (530) 893-0204

[www.TransferFlow.com](http://www.TransferFlow.com)

16. Get ready to start drilling (you will be drilling from the top down).

### **SECTION 3: Mount the Tank**

**NOTE:** The tank cannot be installed with anything other than spray on bed liner between the tank and the bed. Any other insulating material you will need to remove the section the tank sits on, or the entire layer.

17. Drill tank mounting pilot holes with a long 1/8" drill bit. Verify that the pilot holes came through where marked underneath.

18. Prepare for two pilot holes for the hoses and wiring harness in the box side panel. These holes will be enlarged with a hole-saw later. Place the holes in the side of the bed about 2" up from the bed floor. The hole locations relative to the head gate will be different depending on the model year of the vehicle. Place the holes about 3" apart, center to center. Before drilling the pilot holes, make sure you are not drilling into anything valuable such as the outside of the bed, wiring, hoses, or other brackets. **Do not drill these holes in the head gate. If you do the fuel lines and electrical can be damaged.**

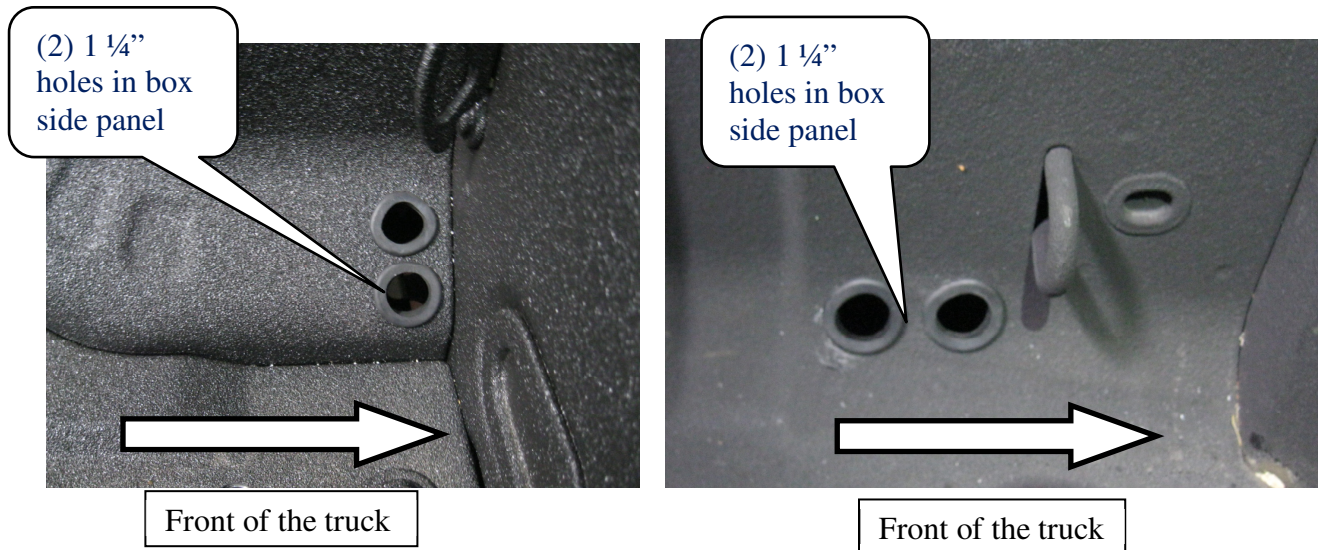

**Figure 7. Pass through grommets in the bed.**



1444 Fortress Street, Chico CA 95973 • (800) 442-0056 / (530) 893-5209 • Fax (530) 893-0204  
www.TransferFlow.com



19. Drill 2 1/8" pilot holes in the location above, verify good placement of the pilot holes and enlarge the holes for the hoses and wiring harness with a 1 1/4" hole-saw. Insert the provided rubber grommets into each hole.
20. Enlarge the tank mounting holes, drilled prior with the 1/8" drill bit with a 9/16" drill bit.
21. Attach the (3) sticky back foam strips to the bottom of the tank or truck bed. Position one strip next to each mounting angle and one strip under the middle of the tank. These strips will prevent the tank from rubbing directly on the bed.

*NOTE: If the bed of the truck has a sprayed-on bed liner the rubber strips may not be required.*

22. Place the tank in its final position.

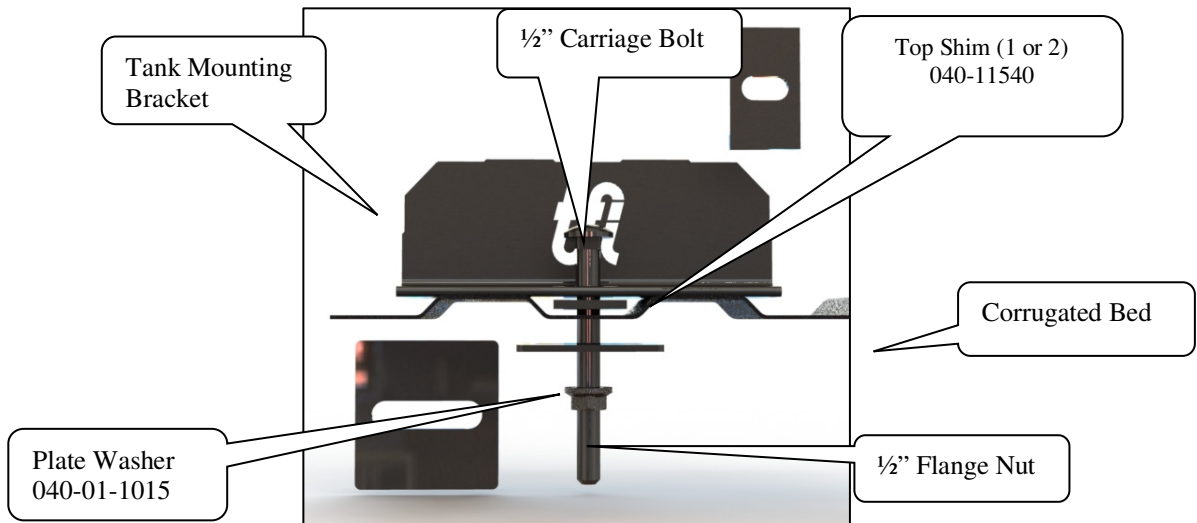

**Figure 8: This is a 100 Gallon in-bed tank your tank may be different than pictured.**

23. Place shims under the mounting brackets to prevent the corrugations from collapsing. It may be necessary to cut the shim to properly fit some pickup boxes.
- **If you are installing a 40-gallon in bed auxiliary tank or 50-gallon refueling tank on 2011 to current module year Ram short bed, Skip the remainder of section 3 and see supplemental instruction sheet IS-929 for tank mounting.**



1444 Fortress Street, Chico CA 95973 • (800) 442-0056 / (530) 893-5209 • Fax (530) 893-0204  
www.TransferFlow.com



**Figure 9. Carriage bolt installation diagram.**

24. Insert the 1/2" carriage head bolts through the mounting brackets and bed.

***NOTE:** : Make sure tank is sitting on the bed corrugations, and not on the shims between the bed corrugations*

***NOTE:** If a 100 gallon in-bed tank is being installed, it is highly recommended using the telescoping magnetic pick up tool to place the hard-to-reach bolts between tank and the bed rail on the rear side mounting holes as the distance to reach them is excessive and may not be reachable with your arm.*

25. Secure fasteners with washers and nuts. Torque the nuts. Refer to Instruction Sheet #484 for proper torque specifications.



1444 Fortress Street, Chico CA 95973 • (800) 442-0056 / (530) 893-5209 • Fax (530) 893-0204  
www.TransferFlow.com

**NOTE:** On some vehicles it may be necessary to install the carriage bolt from under the truck. Place one shim on the head side of the bolt before installing in the bed hole. On the tank feet use one shim and the 1/2" flange nut to secure the tank.

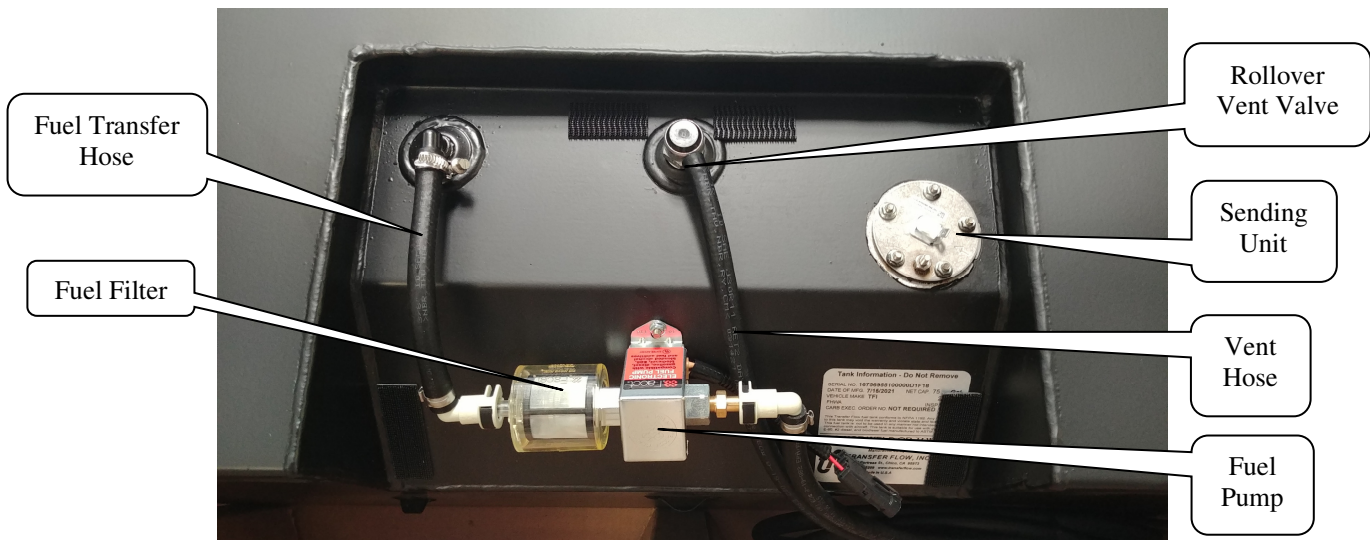

Figure 10. Reverse carriage bolt installation diagram.

**Double check your work:** At this point the tank should be secured in the bed and all of the hardware should be properly torqued. The grommets should be installed in the two holes for the wire harness and hoses. If you are installing a tool box tank, make sure the lid functions without rubbing on the bedrails.

#### **SECTION 4: Plumbing the System**

- **Dodge/Ram Plumbing** – See included instruction sheet IS-930 then skip to Section 5.
- **Ford and GM Plumbing** – Continue to next step



**TF TRANSFERFLOW**  
PREMIER AMERICAN-MADE FUEL SYSTEMS

1444 Fortress Street, Chico CA 95973 • (800) 442-0056 / (530) 893-5209 • Fax (530) 893-0204  
www.TransferFlow.com



**Figure 11: Components underneath cover box on top of in-bed fuel tank**

26. Make sure the fuel transfer hose is hooked up to the Transfer Flow fuel filter and the fuel filter is hooked to the fuel pump.
27. Route both hoses through one grommet in the pickup bed.
28. Crawl under the truck.
29. Locate the main fill hose coming from the fuel fill door to the fuel tank.

***NOTE:** On some Ford vehicles you may use the vent line rather than the main if there is more clearance. You cannot use the vent on any GM vehicles. If you choose to use the vent, follow the below instructions using the black vent 3/4" tee instead.*

30. Find a place that you have clearance to install the provided 1 1/2" fill tee into that hose.
31. Mark that spot on the fill hose.
32. Remove the fill hose from the vehicle and cut it at the previously marked location.
33. Install the tee into the hose with the clamps on it loosely.
34. Reinstall the hose onto the truck.
35. Orient the 3/8" nipple on the tee to where it has optimal clearance. The tee must maintain a downward slope into the fill hose.
36. Pull the 3/8" hose coming off of the Transfer Flow auxiliary tank to the area where you have installed the single tee. Cut the 3/8" hose down to size and install the small hose clamp and the hose onto the 3/8" side of the single tee.



1444 Fortress Street, Chico CA 95973 • (800) 442-0056 / (530) 893-5209 • Fax (530) 893-0204  
www.TransferFlow.com



**Figure 12. Transfer Flow fuel tee installed in the main fuel filler hose.**

37. Secure and torque the provided hose clamps onto the tee. Refer to Instruction Sheet #484 for proper torque specifications.
38. Find the Transfer Flow vent hose that should be attached to the rollover valve (ROV) on the top of the in bed auxiliary tank. Route this hose to a location under the truck where the end can be pointing down and secure the hose with a zip-tie. Do not allow this hose to kink or get pinched shut by the zip tie. The ROV helps vent the tank when you are filling it by venting the top of the tank to the atmosphere. Trim the vent hose to length if necessary.
39. **Double check your work:** at this point all the hose clamps should be tight, and all the hoses should be routed away from hot or sharp objects, exhaust, driveshaft, suspension as well as free from kinks.

### **SECTION 5: Wiring the System**

40. Mount the TRAX 4™ module above the OBDII diagnostic access port.
41. Find the TRAX 4™ wire harness (reference last page of this manual for wire harness diagram).
42. Lay the wiring harness underneath the truck with the fuel tank connections located near the unused grommet hole previously drilled.
43. Push the fuel pump connector, yellow and black wires through the unused grommet in the bed.



1444 Fortress Street, Chico CA 95973 • (800) 442-0056 / (530) 893-5209 • Fax (530) 893-0204  
www.TransferFlow.com

44. Connect the fuel pump and auxiliary sender on the wiring harness. The wiring connectors should plug together with a snap, but you need to make sure that the tongue and groove on each connector is properly lined up. These connectors are designed to only work one way.
- Fuel Pump: Three pin connector w/tan and black wires to three pin connector with red and black wire.
  - Auxiliary Sender: Spade connector with yellow wire to the top center of sending unit.
  - Ring terminal with black wire to ground stud on sending unit.
  - Ground: Attached in the cab near the module to a **UNSHARED** good chassis ground.

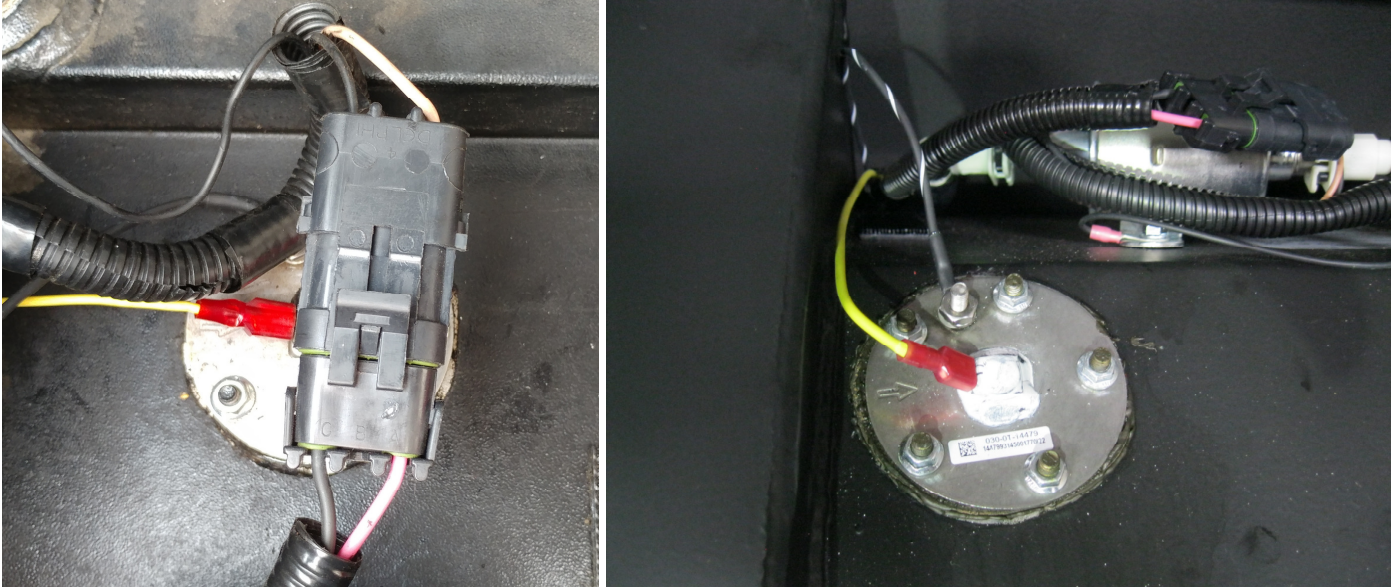

Figure 13. TRAX 4™ auxiliary sending unit.



1444 Fortress Street, Chico CA 95973 • (800) 442-0056 / (530) 893-5209 • Fax (530) 893-0204  
www.TransferFlow.com

45. Remove the OBDII diagnostic access port from the truck's knee bolster panel.



Figure 14. OEM OBDII diagnostic access port.

46. Find the TRAX 4™ OBDII plug.

47. Plug the female OBDII connector into the vehicle's OBDII diagnostic access port that you just removed and secure with a zip tie.

*NOTE: If there is already an OBDII accessory present the TRAX 4™ plug needs to be connected to the vehicle side and other accessories need to be installed downstream of the TRAX 4™ connector*

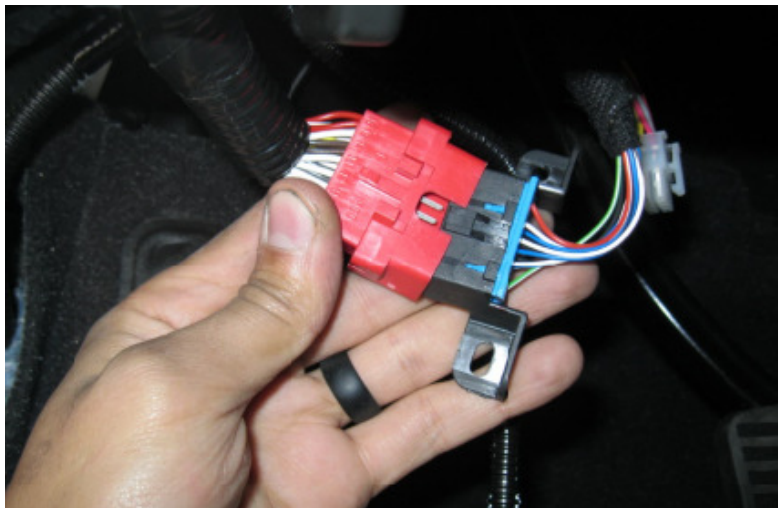
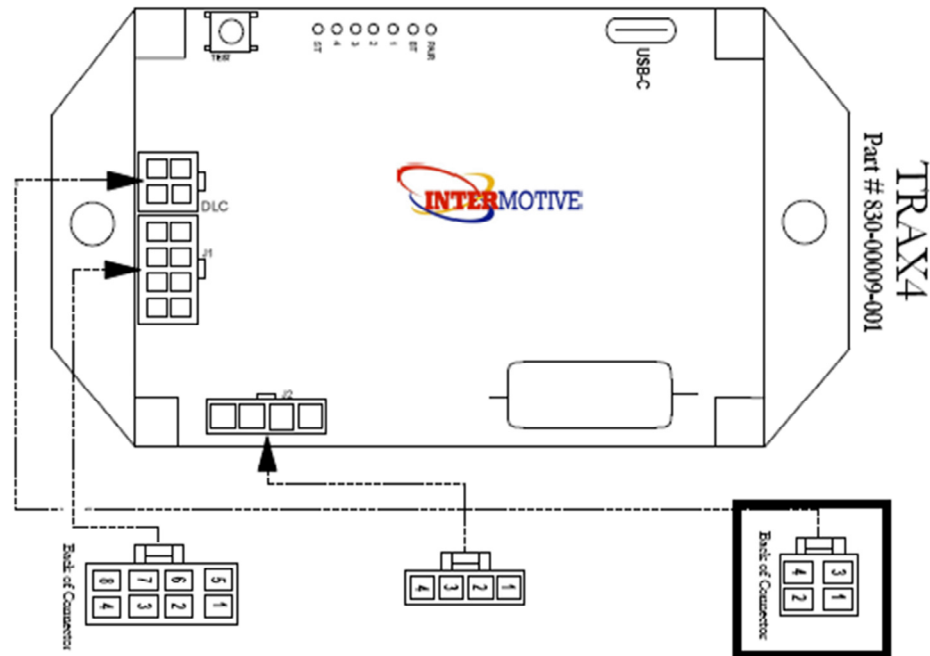

Figure 15. TRAX 4™ plugged into OEM OBDII diagnostic access port.



1444 Fortress Street, Chico CA 95973 • (800) 442-0056 / (530) 893-5209 • Fax (530) 893-0204  
www.TransferFlow.com

48. Attach the male end TRAX 4™ OBDII connector on the TRAX 4™ wiring harness onto the knee bolster where you removed the OEM one.
49. Plug the 4-wire connector coming from the OBDII tee harness into the corresponding plug on the TRAX 4™ module.



**Figure 16. OBDII plug on TRAX 4™ module.**

50. Locate a position in the dash to place the included fuel pump activation push button switch and mark it with a Sharpie® in preparation for drilling. This location will need to be able to receive the body of the switch without any interference of reinforcement panels or any other body components.



1444 Fortress Street, Chico CA 95973 • (800) 442-0056 / (530) 893-5209 • Fax (530) 893-0204

www.TransferFlow.com



**NOTE:** Dash disassembly may be required to install the switch in a location that does not impede critical truck functions. See manufacturer service manual on proper panel disassembly.

51. The following are the recommended Pump button locations on the current model year GM, Ford, and Ram vehicles. For all other model years or if a different location is desired you must first verify that there is proper clearance on the back side of the dash panel before drilling.



**Figure 17. Current model year GM series trucks suggested pump button location.**



**Figure 18. Current model year Ford series trucks suggested pump button location**

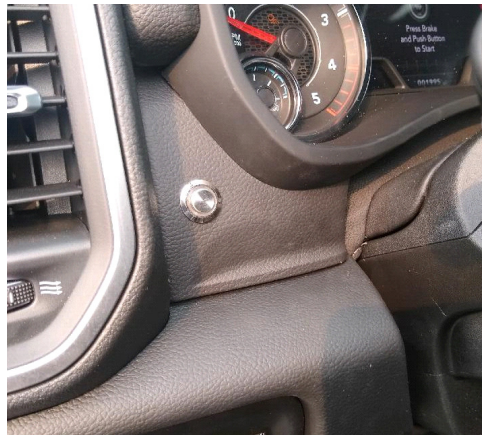

**Figure 19. Current model year Ram series trucks suggested pump button location.**

52. Drill the marked location with a 1/8" pilot drill bit.
53. Ensure the pilot hole will not interfere with any reinforcing structure behind the dash panel.
54. Enlarge the hole to 5/8" with either a 5/8" drill bit or a step bit.



1444 Fortress Street, Chico CA 95973 • (800) 442-0056 / (530) 893-5209 • Fax (530) 893-0204  
www.TransferFlow.com

55. Insert the push button switch wiring through the hole that you just drilled and run it to the female button plug in the main harness. Remember to slide the jam nut for the button over the harness first.



**Figure 20. Manual pump operation button.**

56. Tighten the jam nut on the push button switch.

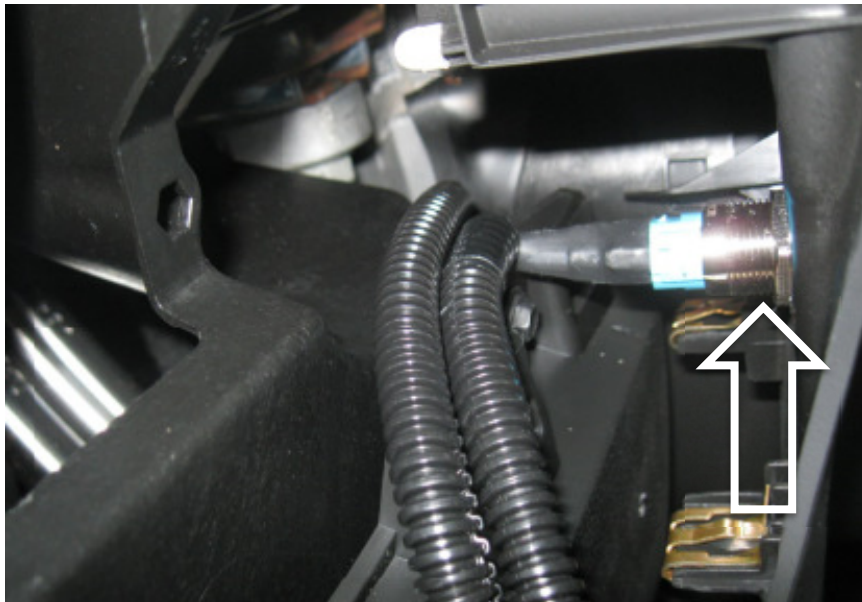

**Figure 21. The jam nut on the back of the manual pump operation button.**



1444 Fortress Street, Chico CA 95973 • (800) 442-0056 / (530) 893-5209 • Fax (530) 893-0204  
www.TransferFlow.com

57. Reassemble the dash if it was disassembled.
58. Plug the button switch plug into the main harness.



**NOTE: THE BUTTON WILL FLASH RED UNTIL THE TRAX 4 MOBILE APP SET UP HAS BEEN COMPLETED. See TRAX 4 Owner's Manual for set up instructions.**

59. Pull all wire switch harness slack toward the module. Bundle and zip tie all extra wire out of the way of the pedals and other critical vehicle controls.
60. Route the Transfer Flow fuel tank wire harness toward the front of the truck.
61. Pass the 6-wire connector wire through a grommeted location into the truck's cab near the TRAX 4™ module. If there is not a good location, drill a 1 ¼" hole with a hole saw in a safe location in the firewall or floorboard. Insert the Transfer Flow provided grommet and pass the 6-wire connector through.



**Figure 22. Example grommet pass through location.**

62. Plug the 6-wire connector into the corresponding plug on the TRAX 4™ module.
63. Secure the tank harness to the driver's frame rail to the OEM harness with zip ties. Do not attach the harness to the fuel lines, brakes lines, or any moving components.



1444 Fortress Street, Chico CA 95973 • (800) 442-0056 / (530) 893-5209 • Fax (530) 893-0204  
www.TransferFlow.com



64. Pull the remainder of this harness into the area of the filler neck, allowing adequate slack for the vehicle to flex and zip tie.



**Figure 23. Excess wiring harness zip tied near the bed pass through grommet.**

65. Reference the Owner's Manual for TRAX 4™ software setup.
66. Affix the Door Post Label and Tire & Loading Label by subtracting the weight in Instruction Sheet #642 from your GVW and putting that weight on the label. If you cannot find your fuel tank on the Instruction Sheet #642 weight list, call Transfer Flow at (530) 893-5209 to get the correct information.



**Figure 24. This kit comes with a new Tire & Loading Label and a new door post label. Update the new labels and place it directly over the old labels.**



1444 Fortress Street, Chico CA 95973 • (800) 442-0056 / (530) 893-5209 • Fax (530) 893-0204  
[www.TransferFlow.com](http://www.TransferFlow.com)



# ATTENTION!

**TRAX 4™ auxiliary tanks must be programmed via the TRAX 4™ mobile app. for the TRAX 4™ system to operate.**

**Please see the TRAX 4™ Owner's Manual for instructions on how to:**

- Download the TRAX 4™ mobile app.
- Connect your phone/TRAX 4™ mobile app to your truck's Bluetooth.
- Set up the TRAX 4™ mobile app to work with your TRAX 4™ auxiliary system.

Scan the QR code below with the camera on your mobile device to access the TRAX 4™ set-up video.



SCAN ME

ANDROID



SCAN ME

iPhone

*Congratulations on a successful installation! Please refer to the Owner's Manual supplied if you have any questions on the operation of this system.*



1444 Fortress Street, Chico CA 95973 • (800) 442-0056 / (530) 893-5209 • Fax (530) 893-0204  
www.TransferFlow.com

# APPENDIX: TRAX 4™ Wire Harness Detail

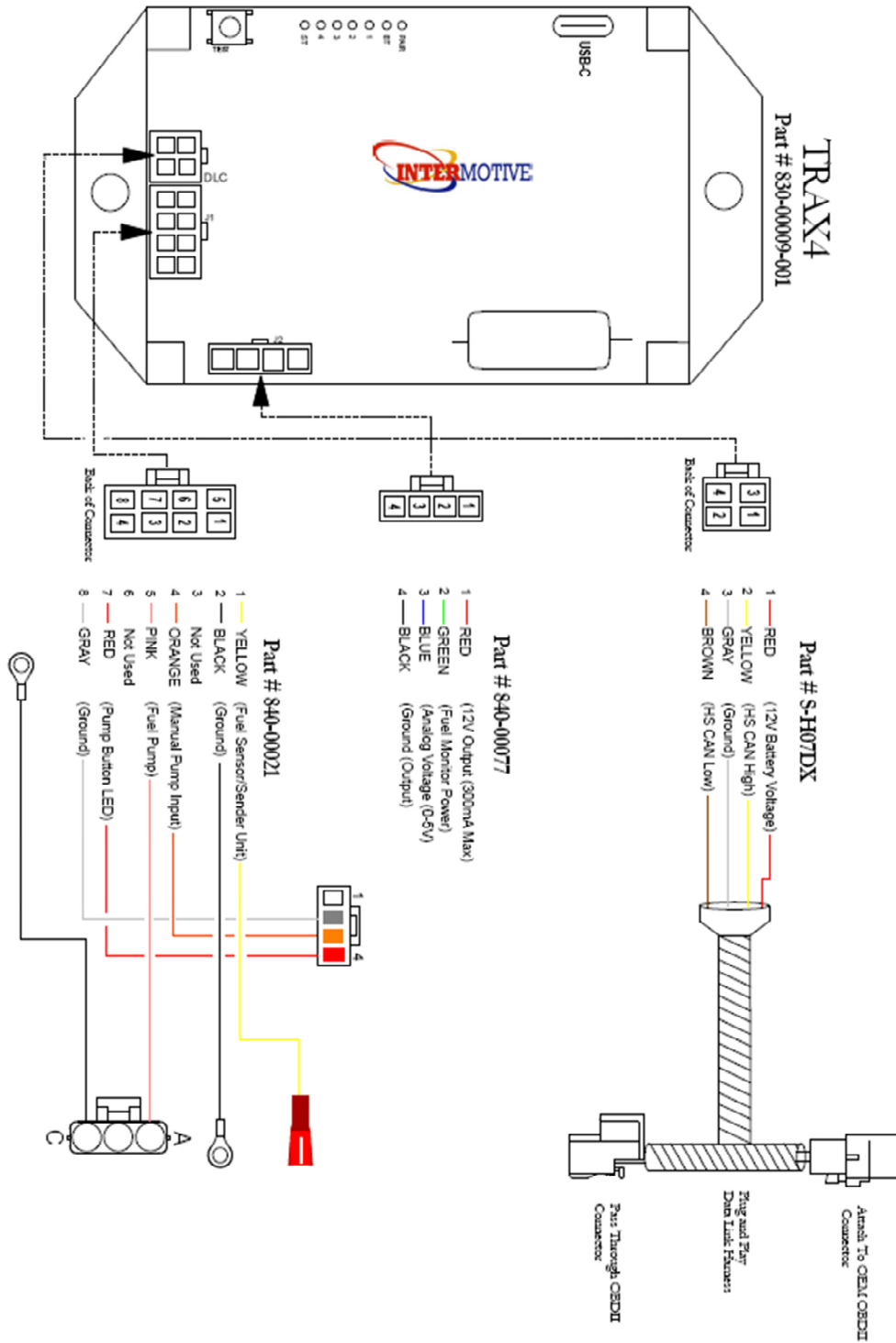

1444 Fortress Street, Chico CA 95973 • (800) 442-0056 / (530) 893-5209 • Fax (530) 893-0204

www.TransferFlow.com