

USER GUIDE.

TJM DOUBLE SWAG.



TAKE THE LEAD.

Facebook Instagram YouTube TJM4x4 | www.tjm.com.au

TJM
4X4 EQUIPPED

TJM DOUBLE SWAG.

Spacious enough for two adults and crafted from 400gsm ripstop canvas (with a raised & reinforced 500gsm PVC bucket floor), the TJM Double swag is designed with Australia's harsh climate in mind. Setting up camp wherever, whenever, couldn't be easier.

However, it's not just strong - but comfortable too! Coming with a high-density foam mattress (complete with a removable and washable cover), a built-in awning, entrance mat, mesh covered doors and windows, and inner storage (to keep your essentials within arms reach) you'll be able to rest in clean, well-ventilated, bug-free comfort wherever you go on your next camping adventure.

SPECIFICATIONS.

Total Weight	16kg
Open Size	205cm (L) x 140cm (W) x 92cm (H)
Pack Size	145cm (L) x 40cm (W) x 40cm(H)
Sleeping Capacity	2 Adults
Materials	<ul style="list-style-type: none">• Main Swag Fabric: 400gsm Ripstop Canvas• Floor Fabric: 500gsm Reinforced PVC• Mesh Windows & Doors: Superfine Mesh• Mattress: 205cm (L) x 136cm (W) x 50mm (H), High Density 35D Foam• Curved Poles: 8.5mm Ø 7 Series High Tensile Aluminium Poles• Ridge Pole: 25mm/22mm Aluminium Telescopic Cam Lock Poles

WARNING!

- Keep all flames & heat sources away from swag fabric.
- Do not operate any fuel burning devices inside swag.
- Do not smoke in swag.
- Be aware of any airborne burning embers that may come in contact with swag.
- Keep fire extinguisher or bucket of water nearby.

FEATURES.

- 400gsm Ripstop canvas
- 500gsm Reinforced PVC with 100mm high bucket floor
- 50mm High resilience, high density foam mattress with removable cover
- Entrance mat
- Internal storage pockets
- Dual storm windows & doors
- Super fine mesh windows & doors
- Includes awning poles for door & storage bag

PARTS LIST.

- 1 x Swag
- 1 x Mattress with removable cover
- 1 set Curved poles (2)
- 1 x Ridge pole
- 1 set Awning poles (2)
- 1 set Guy ropes (4) & ground pegs (8)
- 1 x Storage bag

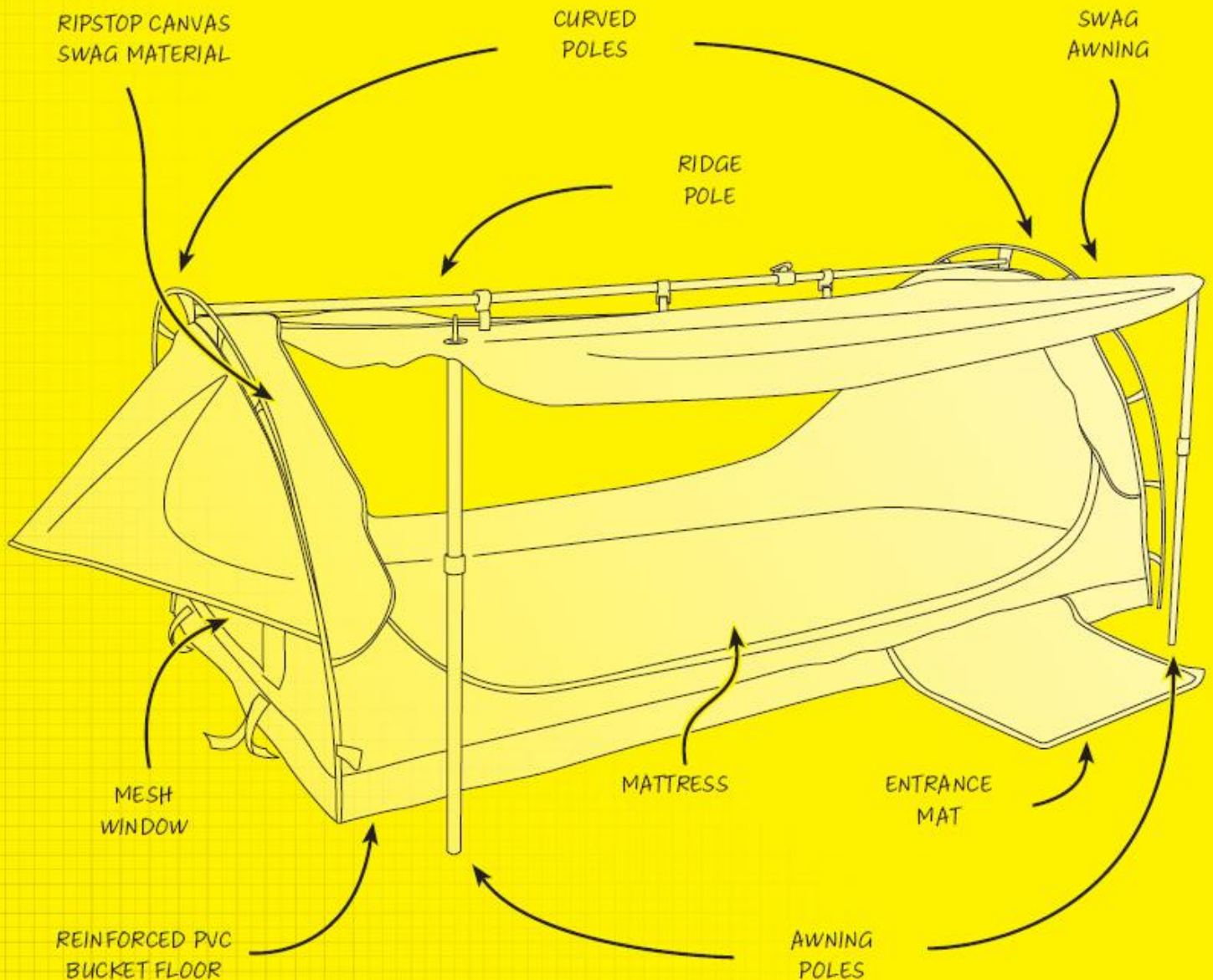

CARE INSTRUCTIONS.

- Keep away from sharp edges, hot surfaces, or hazardous chemicals.
- Clean with light soapy water.
- Prolong life of product, store product away from direct sunlight, wet or humid conditions.
- Dry product completely before storing.

SEASONING.

Seasoning the Swag will allow the canvas fabric to swell around tiny needle holes in fabric caused during the sewing process, providing a watertight seal.

1. Erect the swag & ensure the doors & windows are closed.
2. Completely soak swag fabric with water from hose or rain & allow swag to completely dry.
3. Repeat wetting & drying process 2 to 3 times.
4. Allow swag to completely dry before packing away.

SET UP.



- 1.** Select a flat, well drained area & remove any sharp objects from surrounding area that may puncture floor of swag.

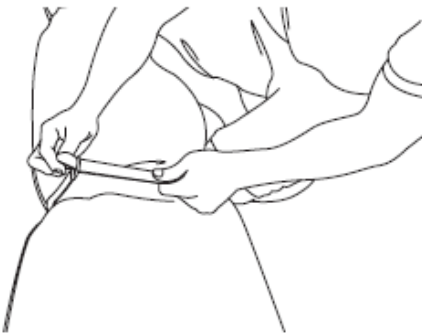

- 2.** Release the 2 straps from D rings & unroll swag

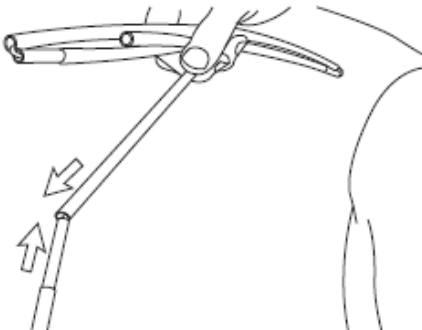

- 3.** Assemble the two curved poles that will attach to the ends of the swag.

WARNING

Curved poles are under extreme tension, ensure no person is standing in line with the curved poles during the next step.

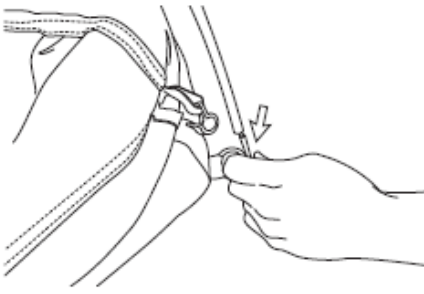

- 4.** Fully insert curved poles into the pins connected at base of swag on both ends.
-

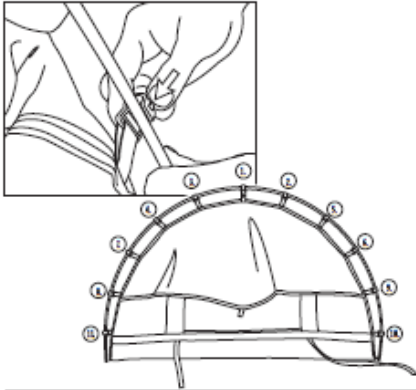

- 5.** Attach the 11 x C clips sewn at each end of swag to curved pole, starting from the top middle & alternating from side to side.
-

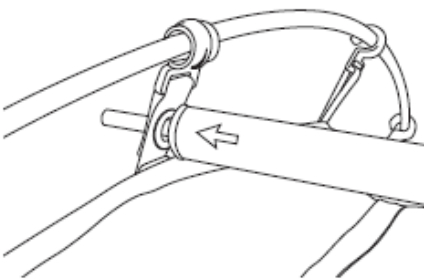

- 6.** Take ridge pole & insert one end of the pin into of top eyelet of swag.
-

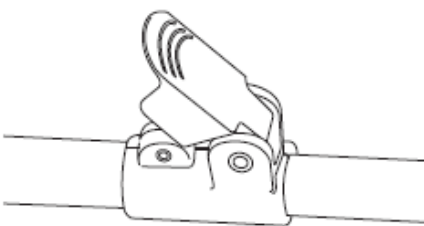

- 7.** Release the cam lock & extend the ridge pole & insert pin on other end of top eyelet of swag.
-

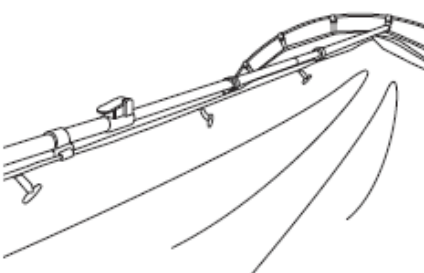

- 8.** Fully extend ridge pole until swag is taut, then lock ridge pole using cam lock.

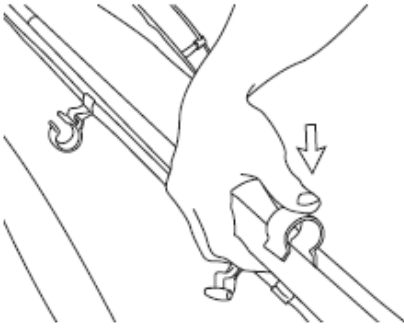

9 Attach 3 large C clips sewn at top of swag to ridge pole.



10.

Peg swag using supplied ground pegs & guy ropes at each end of swag via the storm window.

OPTIONAL: Peg swag using 4 ground pegs at each corner at base of swag through rings attached to pins in step 4.

ERECTING AWNING.

1. Unzip door.
2. Take both awning poles.
3. Twist anti clockwise to loosen & extend pole.
4. Insert pins on poles into eyelet sewn into door.
5. Adjust pole/door to desired height.
6. Twist clockwise to set height.
7. Peg awning poles using guy rope & ground pegs.

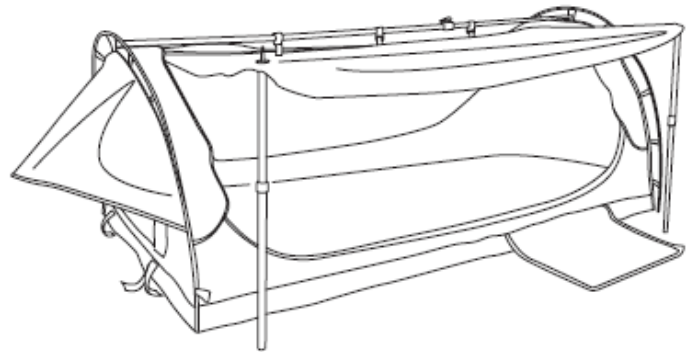

PACKING AWAY.

1. Ensure swag is completely dry before packing away. If not possible, ensure this is done as soon possible to prevent mould, mildew & degradation to fabric & swag parts from occurring.
2. Partially close all zips on windows & doors leaving a small gap to allow air to escape during packing process.
3. Remove all guy ropes & pegs from swag.
4. Release cam lock & remove ridge poles from swag.

WARNING

Curved poles are under extreme tension, ensure no person is standing in line with the curved poles during the next step.

5. Unclip C clips from curved poles & carefully release curved poles from pins.
6. Fold ends of the swag to middle, ensuring any overhanging fabric is folded to middle of swag.
7. From end without D ring & straps, start rolling end of swag & mattress as tightly & evenly as possible until completely rolled up.
8. Grabbing straps, loop them through the D ring to secure rolled swag.
9. Place swag into storage bag & guy rope, pegs, poles into pocket inside storage bag

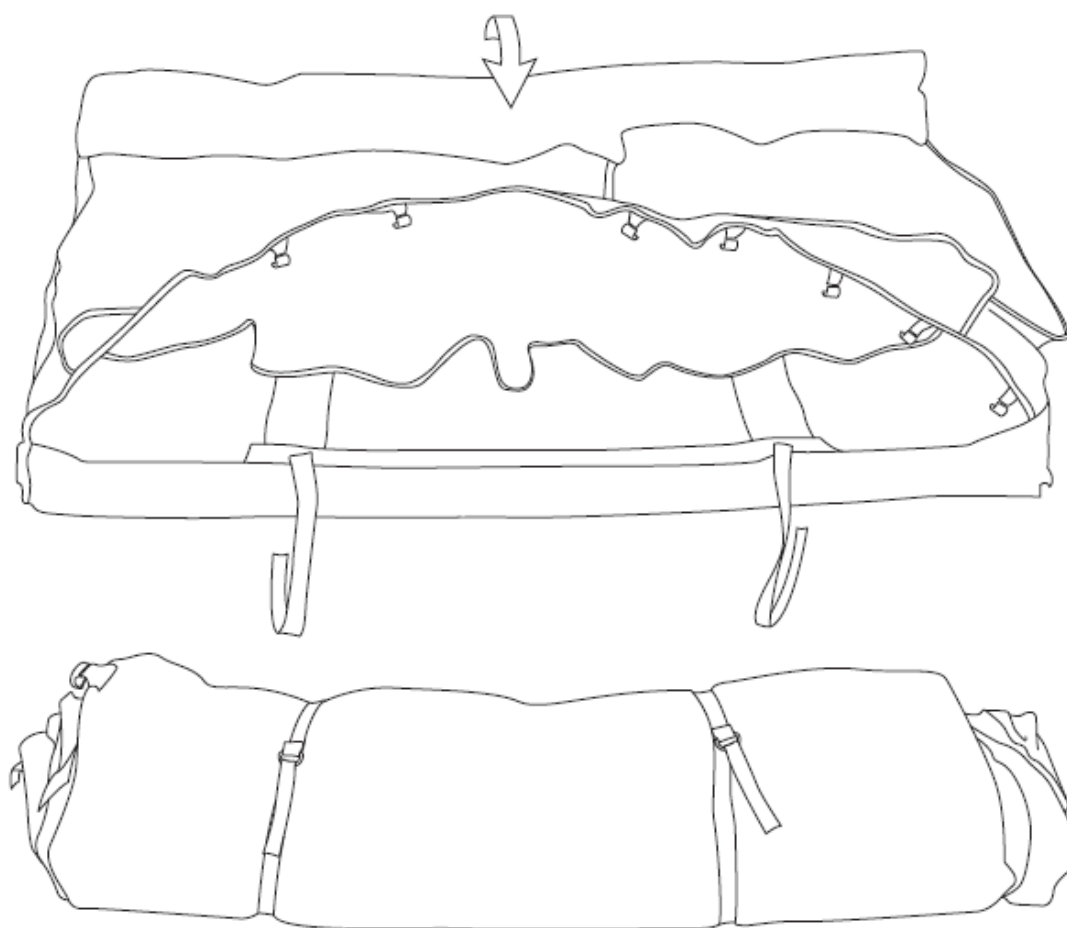

ACCESSORIES AVAILABLE (SOLD SEPERATELY).

1. Anti-Condensation Mat – Part No. 620ACMATSWAG
2. Waterproof Ground Mat – Part No. 620WPGROUNDMAT
3. Soft LED Light Strip – Part No. 620SOFTLEDSTRIP

Distributed by TJM Australia
17 Johnstone Road Brendale Q 4500

