



DINAN

FRONT STRUT BRACE INSTALLATION INSTRUCTIONS

D180-0010

Fits: 2008-09 135i
2007-09 335i/xi



Congratulations for being selective enough to use a Dinan Engineering Front Strut Brace. We have spent many hours developing this kit to assure that you will receive maximum performance and durability with minimum difficulty in installation.

Please take the time to read these instructions thoroughly before proceeding. When performing the installation, read the entire numbered instruction before working on the vehicle. If you feel that you do not have the requisite skill, please arrange for a qualified repair facility to perform the installation.

If you encounter any difficulties during the installation, or if these instructions are not clear to you, please call Dinan's Technical Support Staff at (408) 779-8584.

Installation Notes:

- To prevent unwanted alignment changes when installing this strut brace, leave the vehicle on the ground.
- The stock positive battery terminal in the engine compartment will interfere with the Dinan Strut Brace. A shortened battery terminal is included in this kit. The vehicle battery must be disconnected during installation. Take care to prevent accidental reconnection of the battery while work is being performed!
- Before reconnecting vehicle battery, double-check that all electrical connections are secure!

PARTS LIST

Qty	Part #	Description
	D182-0036	Center Section
	D183-0033	Left Endplate Assembly
	D183-0034	Right Endplate Assembly
	D183-0029	Shortened Battery Terminal w/ cover
	D183-0017	Hardware Kit; includes (1) BMW Battery Terminal clip (6) M8 Recess Nuts (4) M8x35mm Button-head Screws (8) 8mm Flat Washers (4) M8 Nylock Nuts

INSTALLATION INSTRUCTIONS

1. Open trunk, remove battery cover, and disconnect the negative battery cable. Secure the cable out of the way and cover the negative battery terminal to prevent accidental contact.

2. Open hood and remove the upper microfilter housing (see Figure 1).
 - A. Remove the screws at (1), (2), and (3).
 - B. Lift out microfilter housing (4) and set aside.

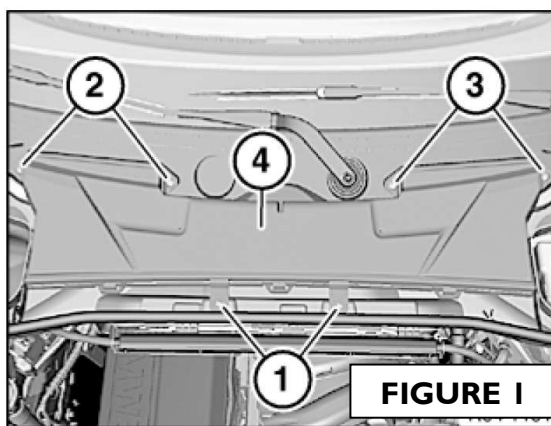

3. Remove the driver-side cover (see Figure 2).
 - A. Move aside the rubber latch at (1).
 - B. Release the catches at (3).
 - C. Remove cover (2) and set aside.

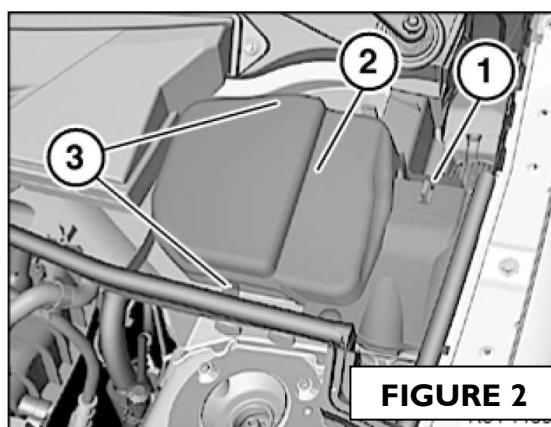

4. Remove the passenger-side cover in a similar manner, taking care to separate the windshield washer hose and clip if needed.
5. See Figure 3. Disconnect the sensor (1) and unclip the wiring harness from the guides (2).

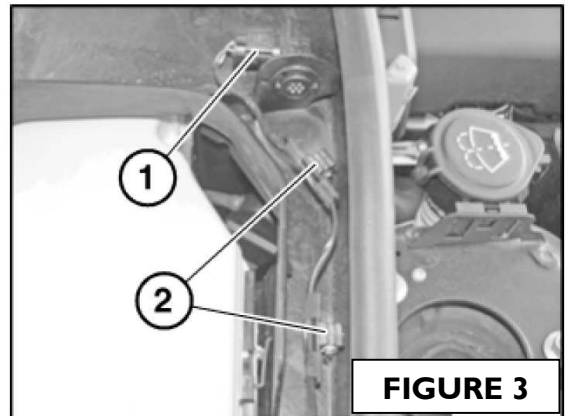

6. Remove the wiring tray (see Figure 4).
 - A. Unclip the top cover and set aside (this will no longer be needed).
 - B. Unclip both wires from the lower tray.
 - C. Using a small flat screwdriver, depress the latches (3) and pull out the lower tray (this will no longer be needed).

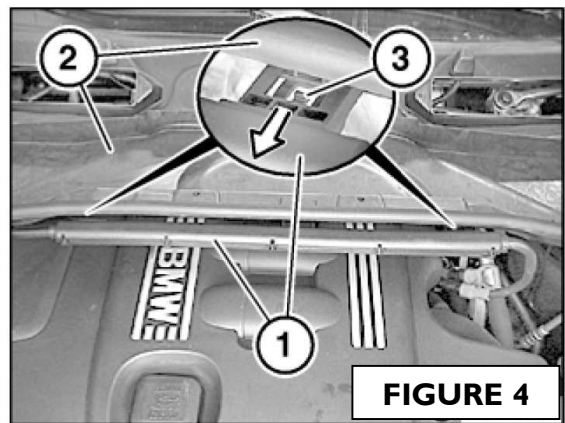

7. Separate the wiring harness from under the lower microfilter housing (see Figures 5 and 6).
 - A. Insert small flat screwdriver at locations shown.
 - B. Depress the latch and pull forward on the harness to separate it from the lower microfilter housing.

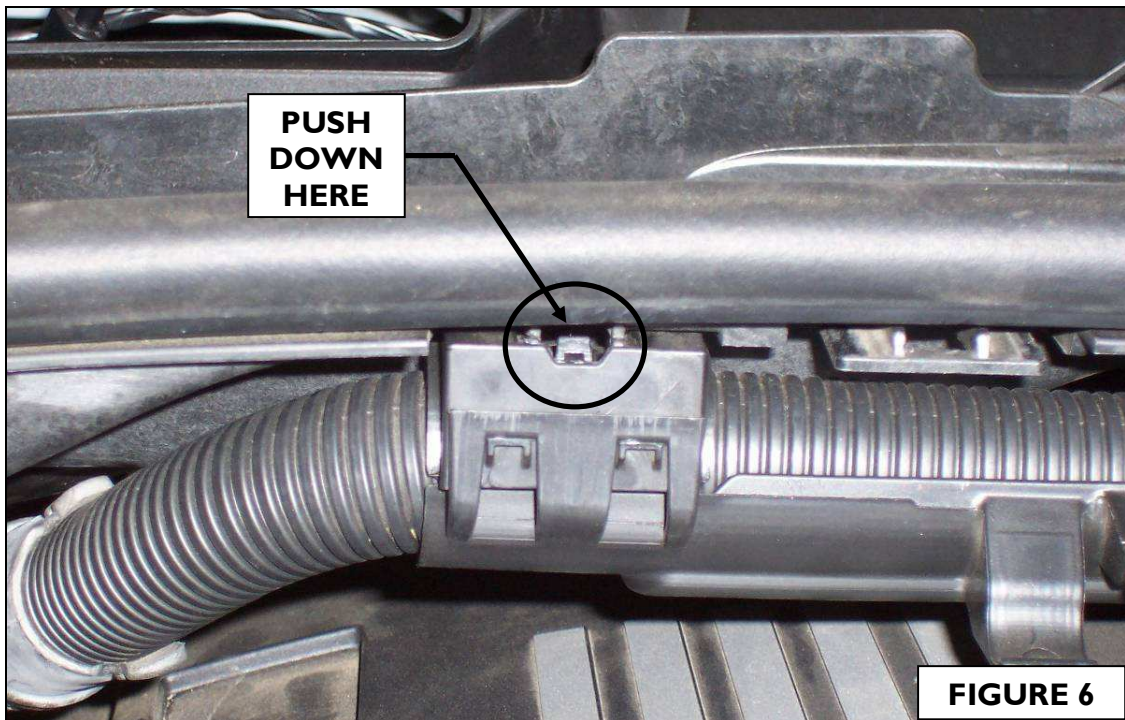
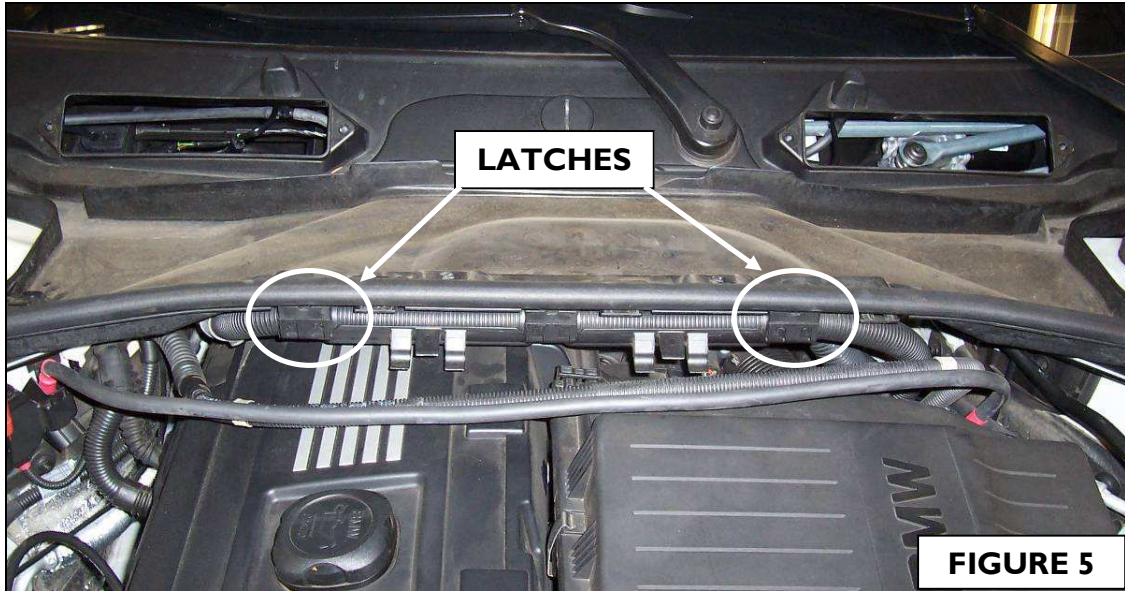

8. Remove lower microfilter housing (see Figures 7 and 8).
 - A. Move aside the rubber latch at (1) on both sides.
 - B. Remove the screws at (1) on both sides. Note – these screws are a fine thread. Do not confuse these screws with those removed earlier in Step 2!
 - C. Slide lower microfilter housing in direction of arrows to remove from vehicle, and set aside.

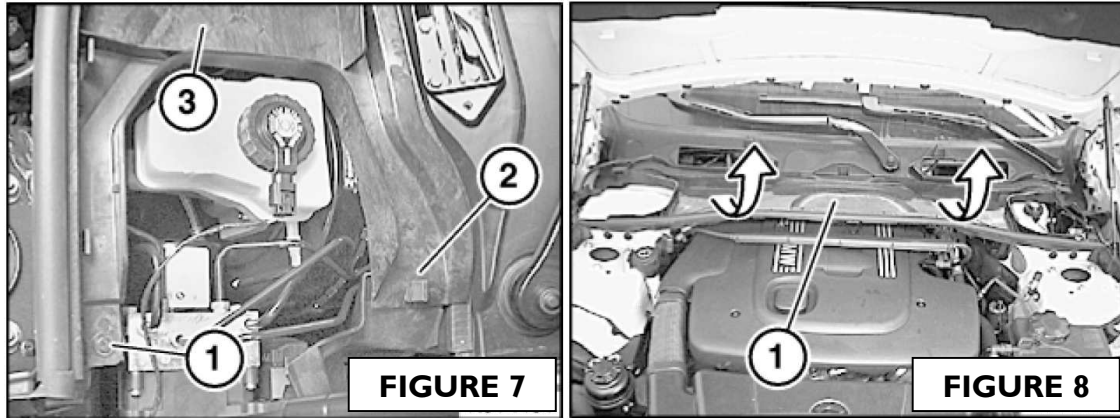

9. See Figure 9. Remove the black plastic circular cover at the base of the windshield. Insert large flat screwdriver in slot shown, rotate ¼ turn counter-clockwise, and remove cover.

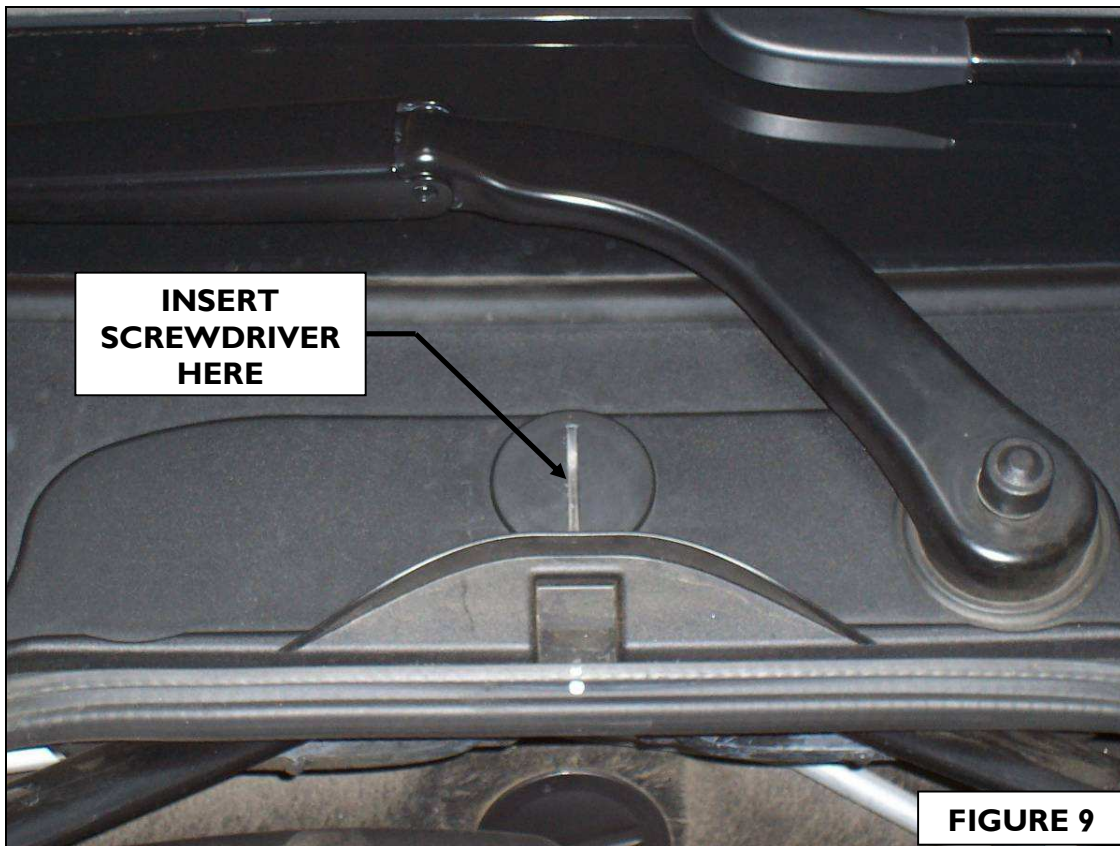

10. See Figure 10. Using an E18 socket, loosen the bolt below the cover several turns. It is not necessary to remove this bolt.



11. Remove V Braces from vehicle (see Figure 11).
- A. Using an E14 socket, remove the bolts from the ends of the V Braces.
 - B. The V Braces are different from left to right. Note that the chamfers at the ends are towards the outside of the vehicle.
 - C. Pull out the V Braces from the vehicle and set aside.

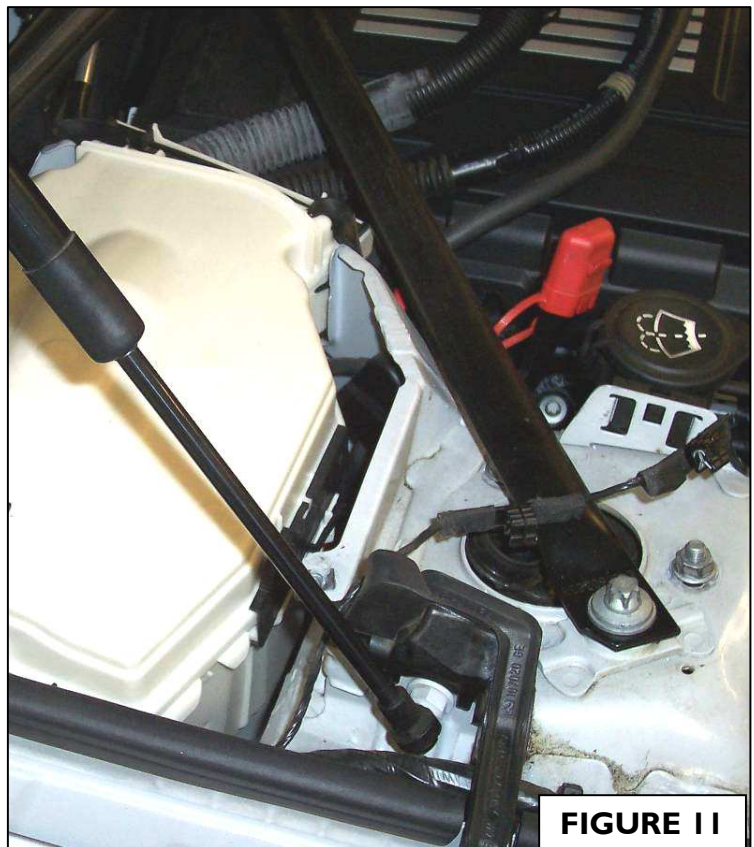

- 12.** Remove cover from electronics box (see Figure 12).
- A. Push the two slide locks in the direction of the arrows (there are also lock/unlock symbols molded onto the cover).
 - B. Remove from vehicle.



- 13.** See Figure 13. Remove the inside cover (1) of battery terminal. Disconnect both inside cables from the battery terminal. Do not drop the nuts down into the electronics box.

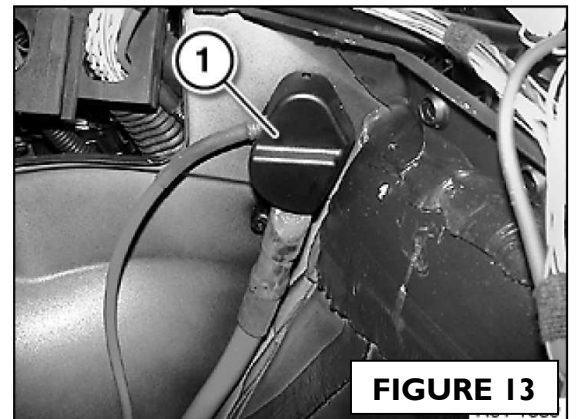

- 14.** See Figure 14. Remove the outside cover (1) of battery terminal.

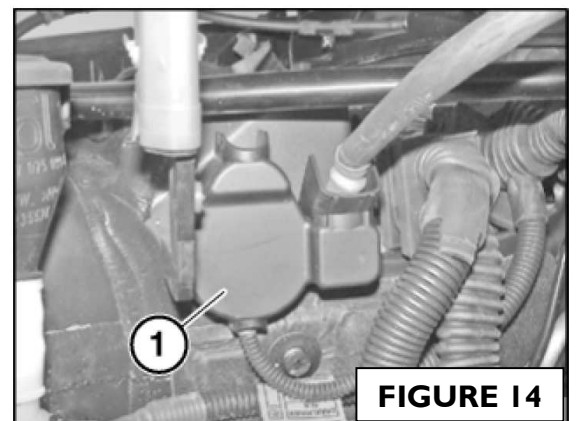

15. See Figure 15. Disconnect both outside cables (1) from the battery terminal.
16. Release the three latches (2) and remove the battery terminal and inside frame (3) from vehicle. These are no longer needed.

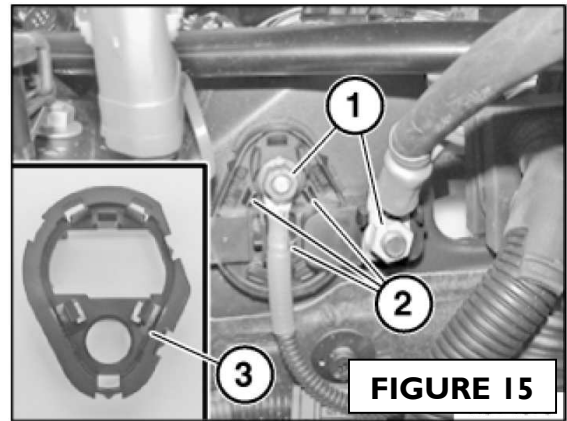

17. Install the Dinan battery terminal using the new inside frame included with kit. Ensure that the new terminal is securely held in place, and the rubber terminal cover is properly attached.
18. Reattach all four wires to the new battery terminal.
19. Double-check all connections to be sure that they are secure. Replace the inside & outside covers.
20. Replace the electronics box cover.
 - A. The two slide locks must be released from the unlocked position. Lift up on the latch to release the slides.
 - B. Install cover and lock both slides.
21. Remove the strut tower nuts (3 per side). These are no longer needed.
22. Place the endplates on the studs and loosely install the recess nuts. Washers are not used with the Dinan recess nuts.

23. See Figure 16. Using the hardware provided, loosely install the Dinan center section onto the endplates. Do not tighten these bolts.

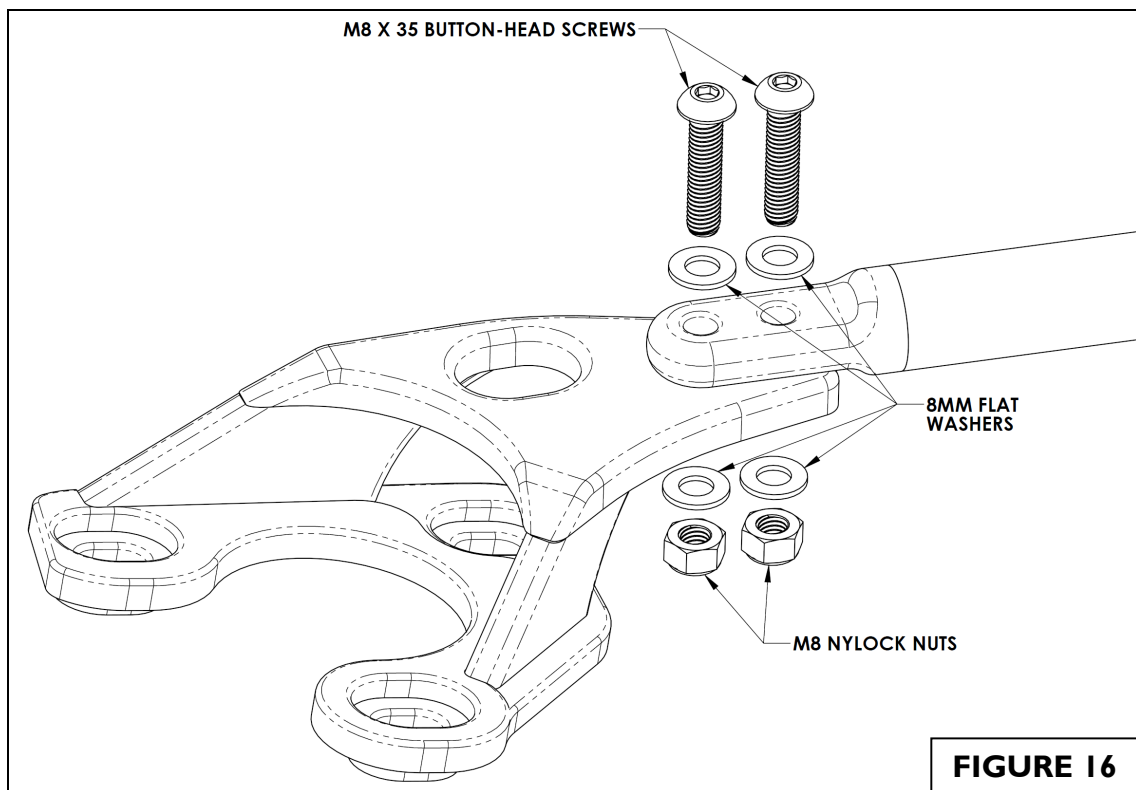

24. Slide strut brace assembly side-to-side until it is centered in the car, and torque the Dinan recess nuts to 25 ft-lbs. Do not over-tighten!
25. Remove the Dinan center section from vehicle.
26. Reinstall V Braces into vehicle. Remember that the chamfers face the outside.
- A. Slide braces thru the endplates and into the rubber boots at the firewall.
 - B. Torque the center bolt to 74 ft-lbs., and replace the plastic cover.
 - C. Torque the outer bolts to 30 ft-lbs.
27. Reinstall the lower microfilter housing.
- A. Take care to engage all the clips at the firewall.
 - B. Verify that the rubber latches (2) on both sides are in their slots (see Figure 7).
 - C. Reinstall the screws (1), one at each side (see warning in Step 8).

28. See Figure 17. Tuck the small wiring harness behind the large harness, and reattach the large harness to the lower microfilter housing. The small harness will be hidden underneath the microfilter housing, behind the large harness. Clip the positive battery cable to the large harness as shown.

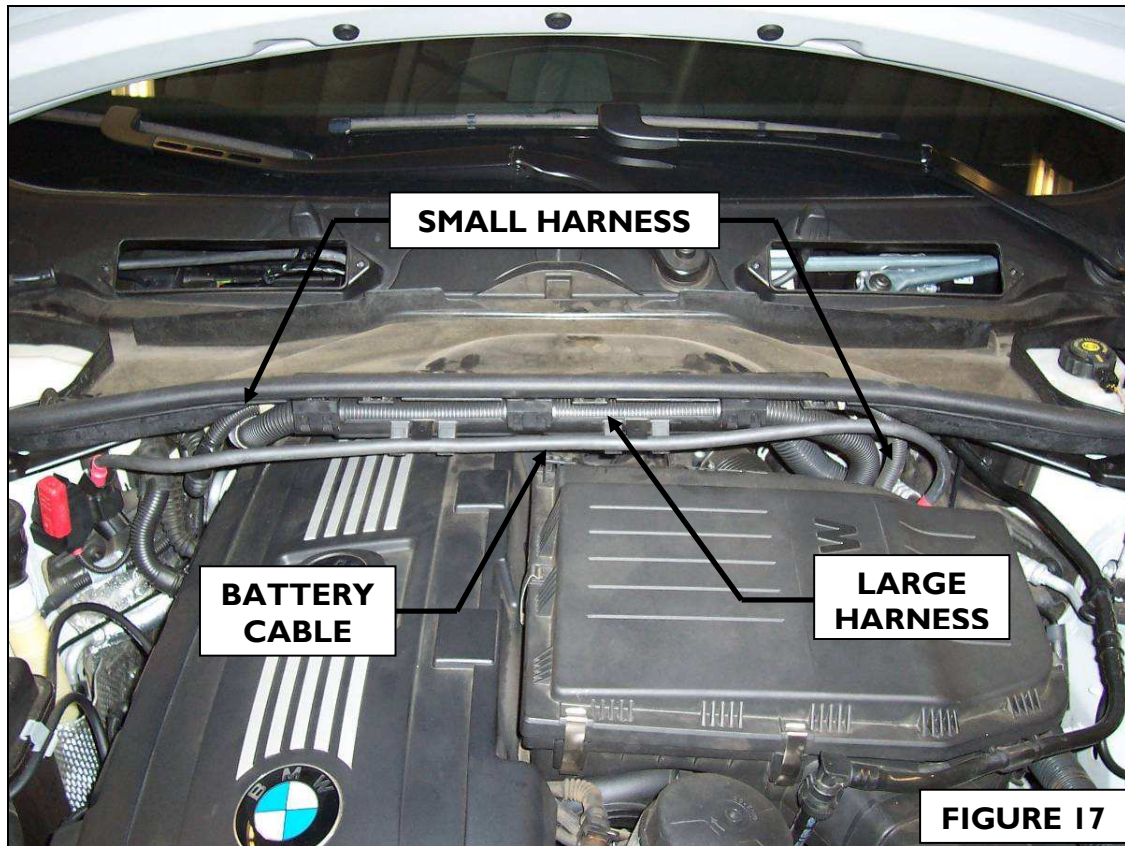

29. Reinstall the sensor harness removed in Step 5.
30. Replace the covers removed in Steps 3 and 4. Verify that the rubber latches are in their slots.
31. Replace the upper microfilter housing.
32. Reinstall the Dinan center section using the hardware provided (see Figure 16), and torque bolts to 20 ft-lbs.
33. Double-check that all electrical connections are secure. Reattach negative battery cable.