

Honeywell Garrett® GT3076R

Compressor Inlet

HOSE CONNECTIONS
TABULATED AS (Ø x L)

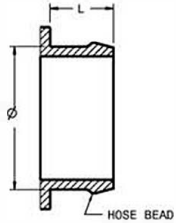

Ø 103.6 x 31.75

Compressor Outlet

HOSE CONNECTIONS
TABULATED AS (Ø x L)

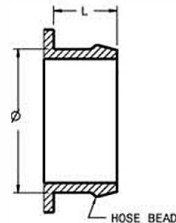

Ø 50.8 x 30

Oil Inlet

0.4375IN-24
THREAD FOR Ø6.35 TUBE
INVERTED FLARE CONNECTION
PER SAE J512 (OIL INLET)

Turbine Inlet

"T3" PN74902-1, 2, 3, 7, 8, 9

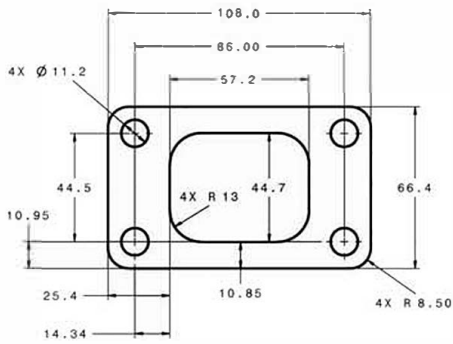

"T4 UNDIVIDED" PN74902-13, 14, 15

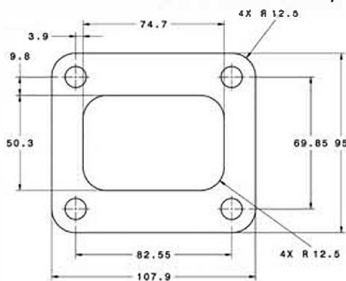

Turbine Outlet

"3-INCH 4 BOLT" PN740902-1, 2, 3

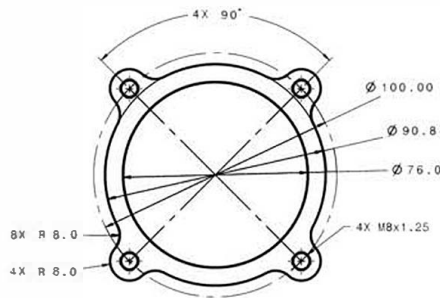

PN740902-7, 8, 9, 13, 14, 15

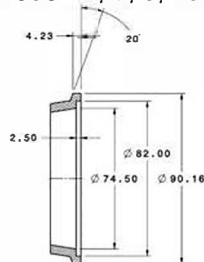

Oil Outlet

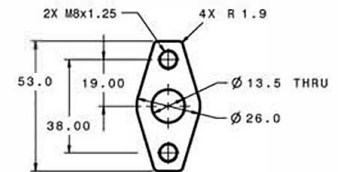

Water

M14 x 1.50

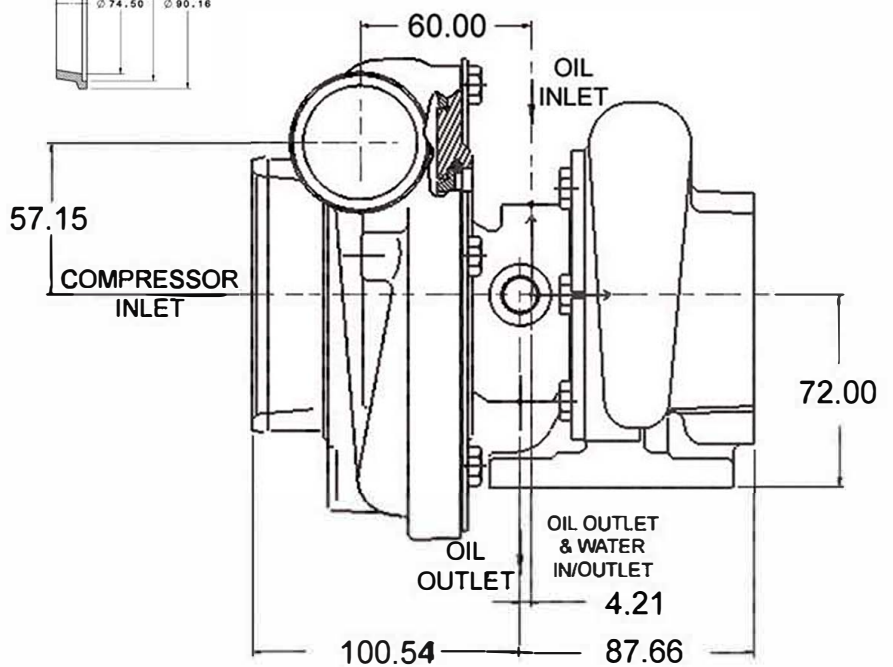

All Measurements in MM