

Item	Description	Qty
A	Rear Shock Bracket Brace	1
B	Front Shock Bracket	1
C	Rear Shock Brackets	2
D	Shock Bracket Base, Right	1
E	Shock Bracket Base, Left	1

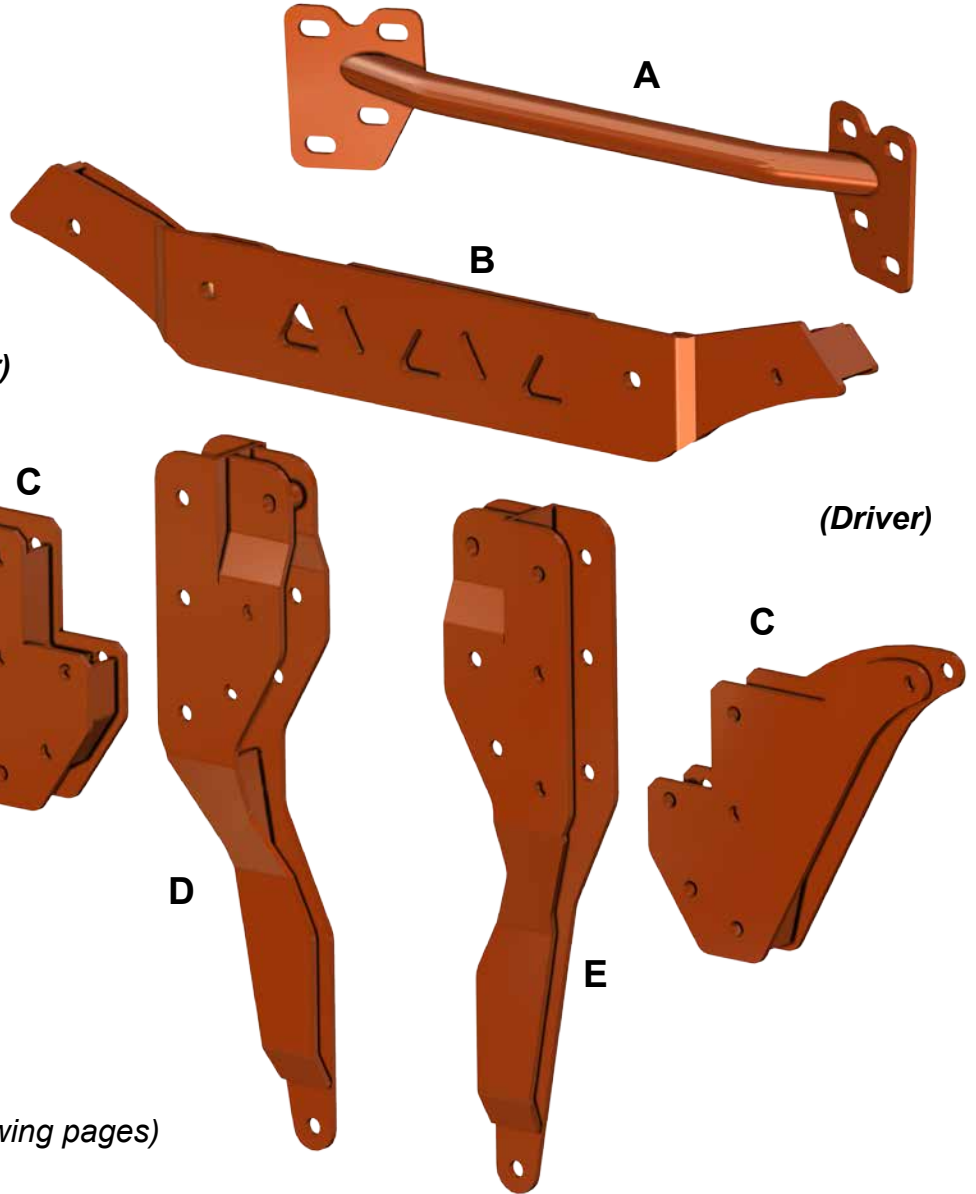

Read instructions and view illustrations before beginning.

Need help with your installation?



sales@superatv.com



www.superatv.com



1-812-574-7777



8:00am - 9:00pm EST M-Th
 8:00am - 7:00pm EST Friday
 9:00am - 2:00pm EST Saturday

Thank You

For Choosing

Liability Statement

SuperATV's® products are designed to best fit user's ATV/UTV under stock conditions. Adding, modifying, or fabricating any factory or aftermarket parts will void any warranty provided by SuperATV® and is not recommended. SuperATV's® products could interfere with other aftermarket accessories. If user has aftermarket products on machine, contact SuperATV® to verify that they will work together.

Although SuperATV® has thousands of satisfied customers, user should be aware that installing lift kits, long travel, or suspension kits, tires, etc. will change the ride of machine and may increase maintenance and part wear. Operating any off-road machine while, or after, consuming alcohol and/or drugs increases risk of bodily harm or death. No warranty or representation is made as to this product's ability to protect user from severe injury or death. SuperATV® urges operators and occupants to wear a helmet and appropriate riding gear at all times.

By purchasing and installing SuperATV® products, user agrees that should damages occur, SuperATV® will not be held responsible for loss of time, use, labor fees, replacement parts, or freight charges. SuperATV®, nor any 3rd party, will not be held responsible for any direct, indirect, incidental, special, or consequential damages that result from any product purchased from SuperATV®. The total liability of seller to user for all damages, losses, and causes of action, if any, shall not exceed the total purchase price paid for the product that gave rise to the claim.

SuperATV® will warranty only parts provided by SuperATV®. Any damage or problems with OEM housings, bearings, seals, or other manufacturers' products will not be covered by SuperATV®. SuperATV® parts and products are not warranted if item was not installed properly, misused, or modified.

(Kit contents continued)

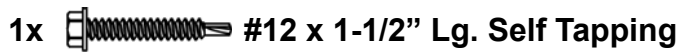
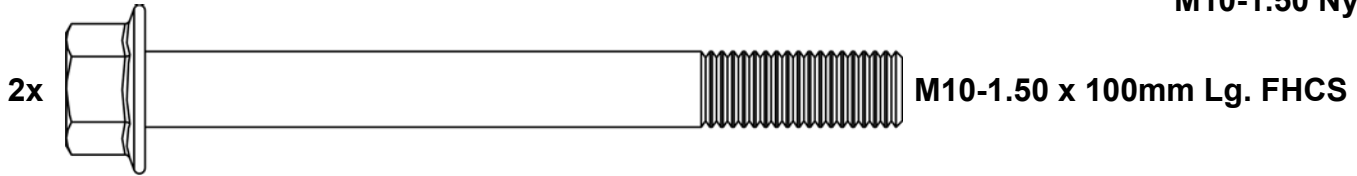
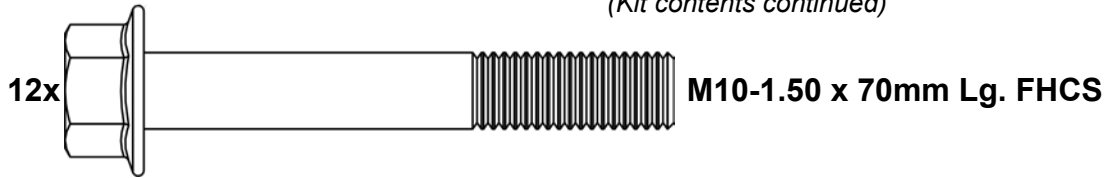

Front components shown must be removed; *Keep all components removed from machine.*

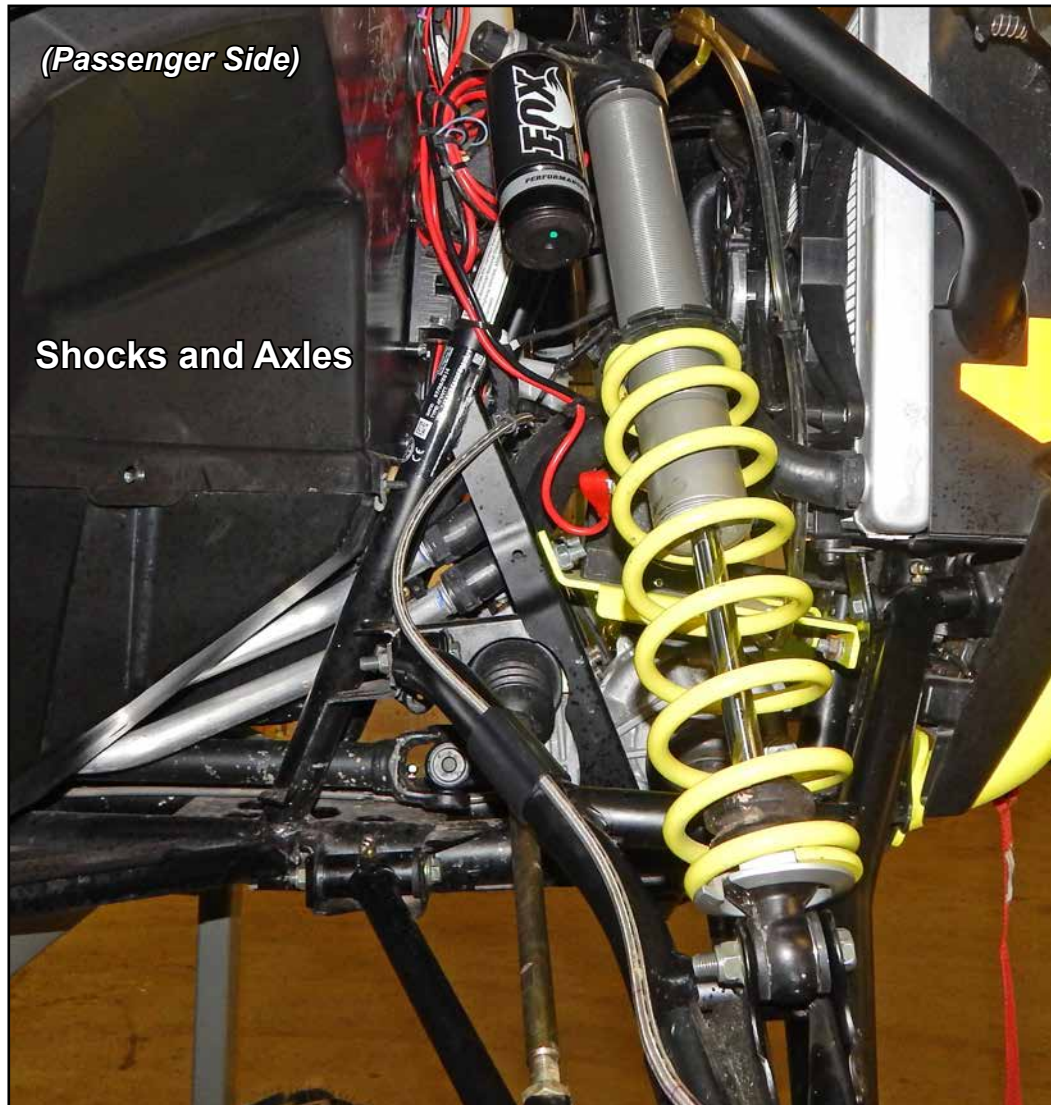

Rear components shown must be removed; Keep all components removed from machine.

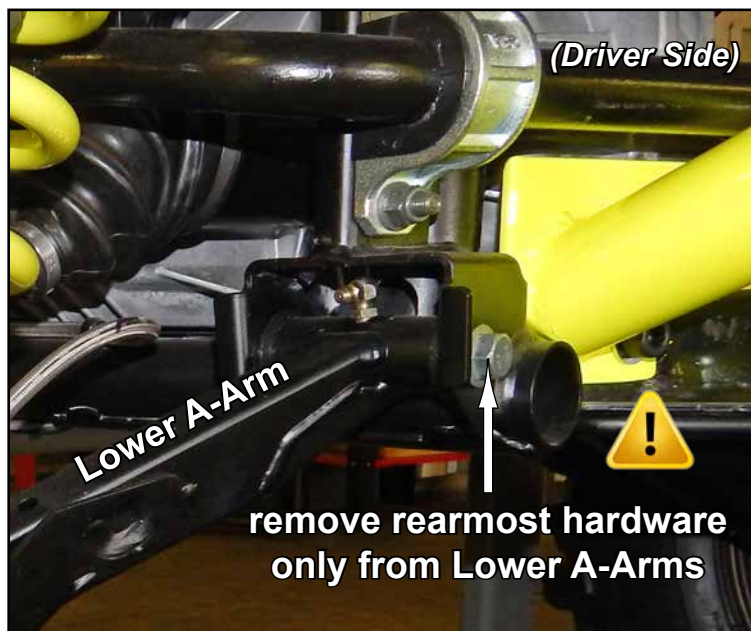
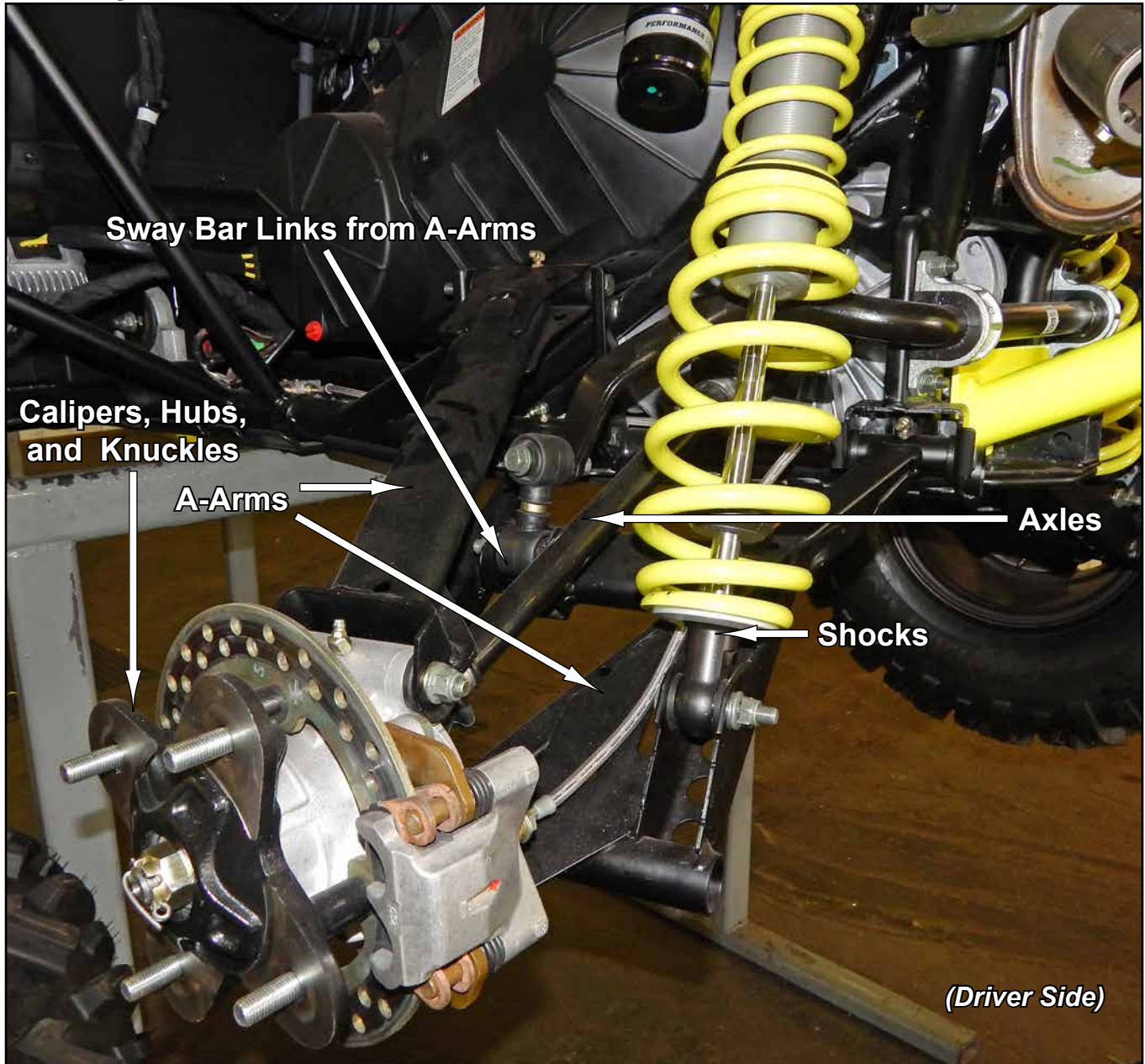

If present, relocate Relay.

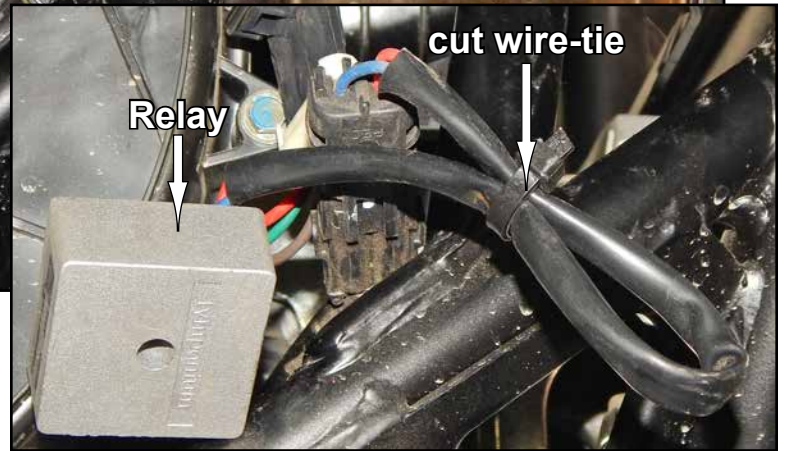
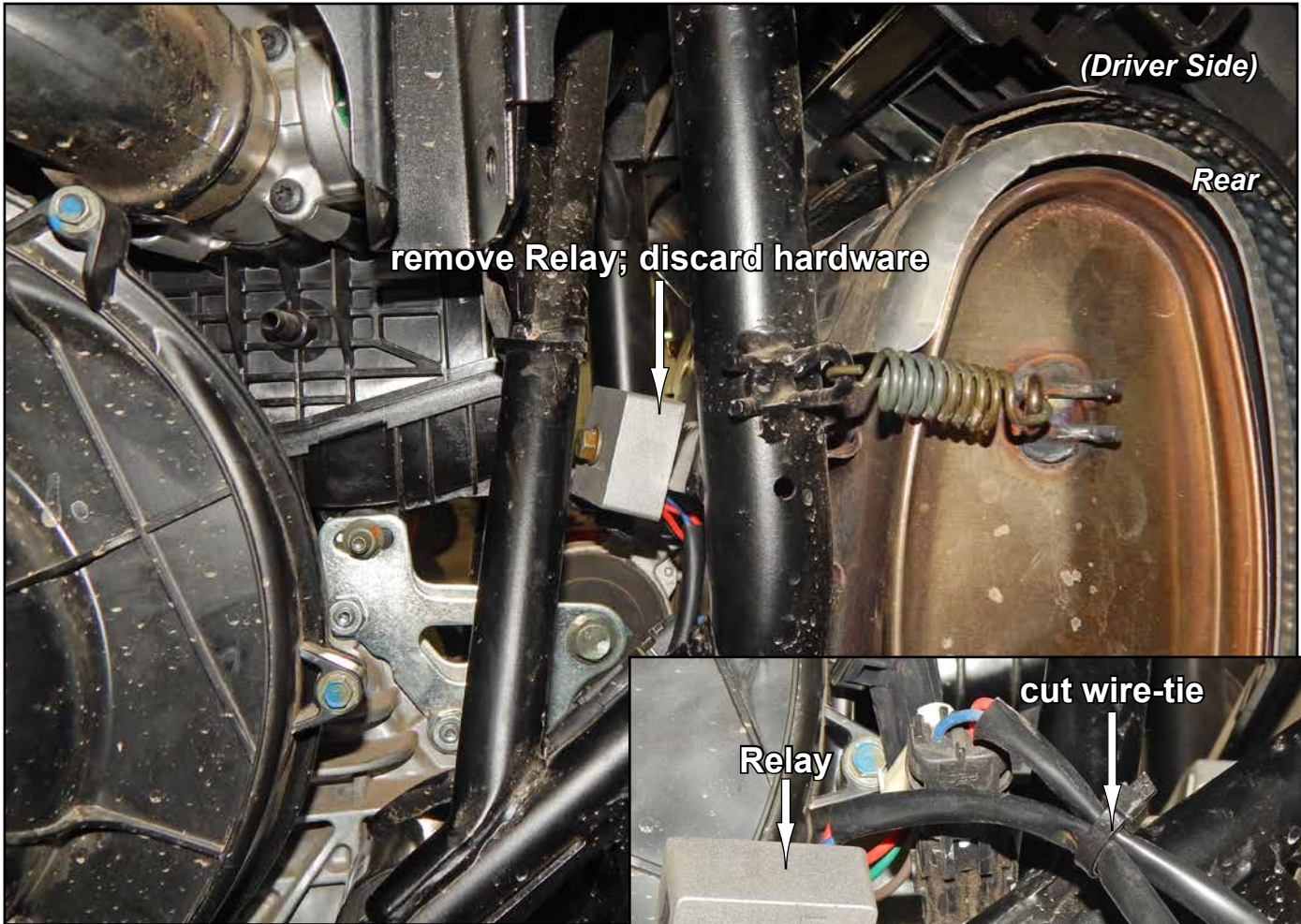

Rear Assembly Reference; do not completely assemble at this time

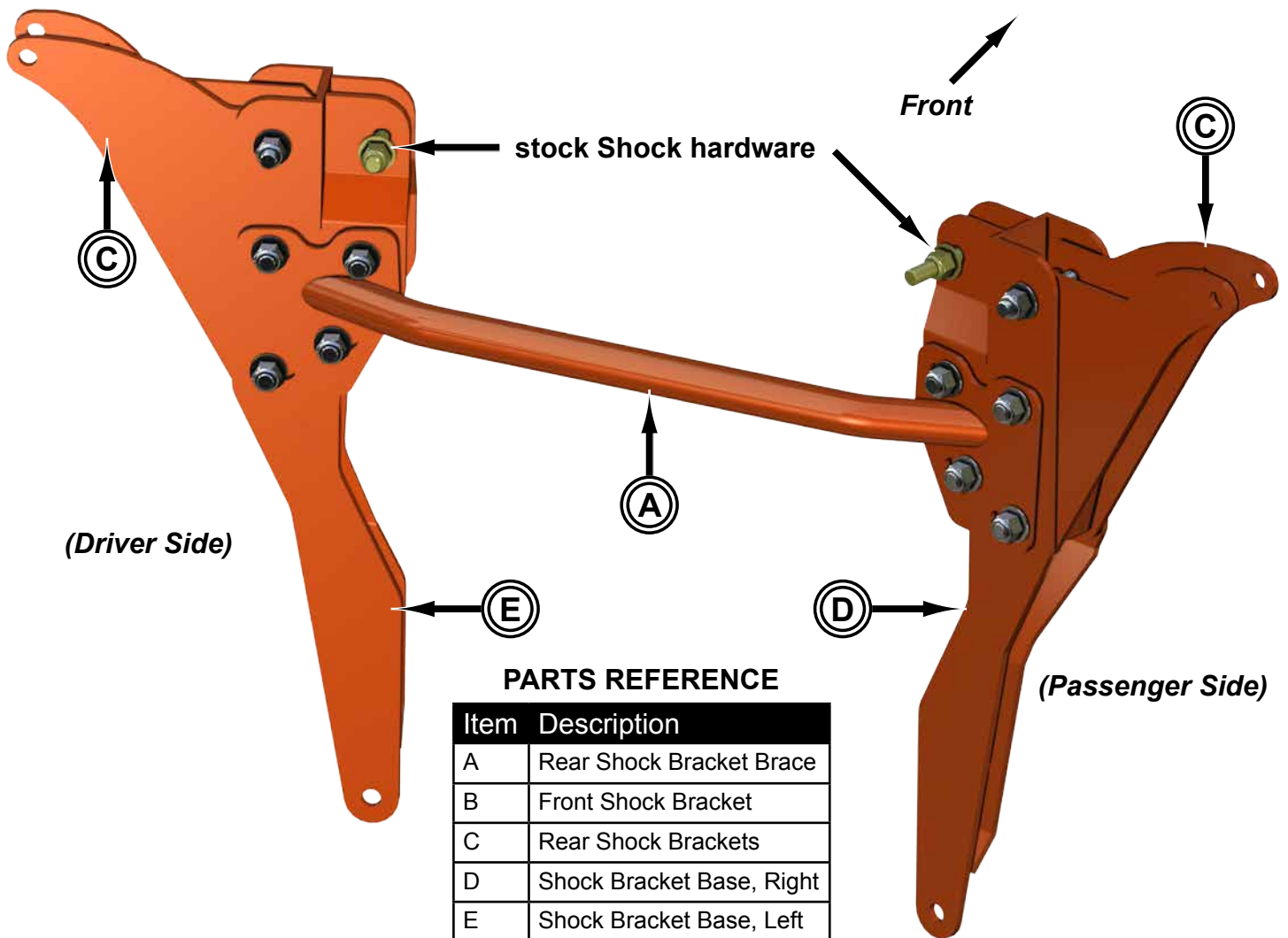

(Rear installation illustrations continue on following pages)

Rear Installation: *Do not tighten hardware completely until last step.*

- Install Shock Bracket Base, Left (E) into stock Shock Mount with stock Shock hardware.
- Install hardware shown to rear portion of Lower A-Arms; **do not add M10 Nut.**
- Place lower hole in Shock Bracket Base, Left (E) onto previously installed bolt and secure with nut.

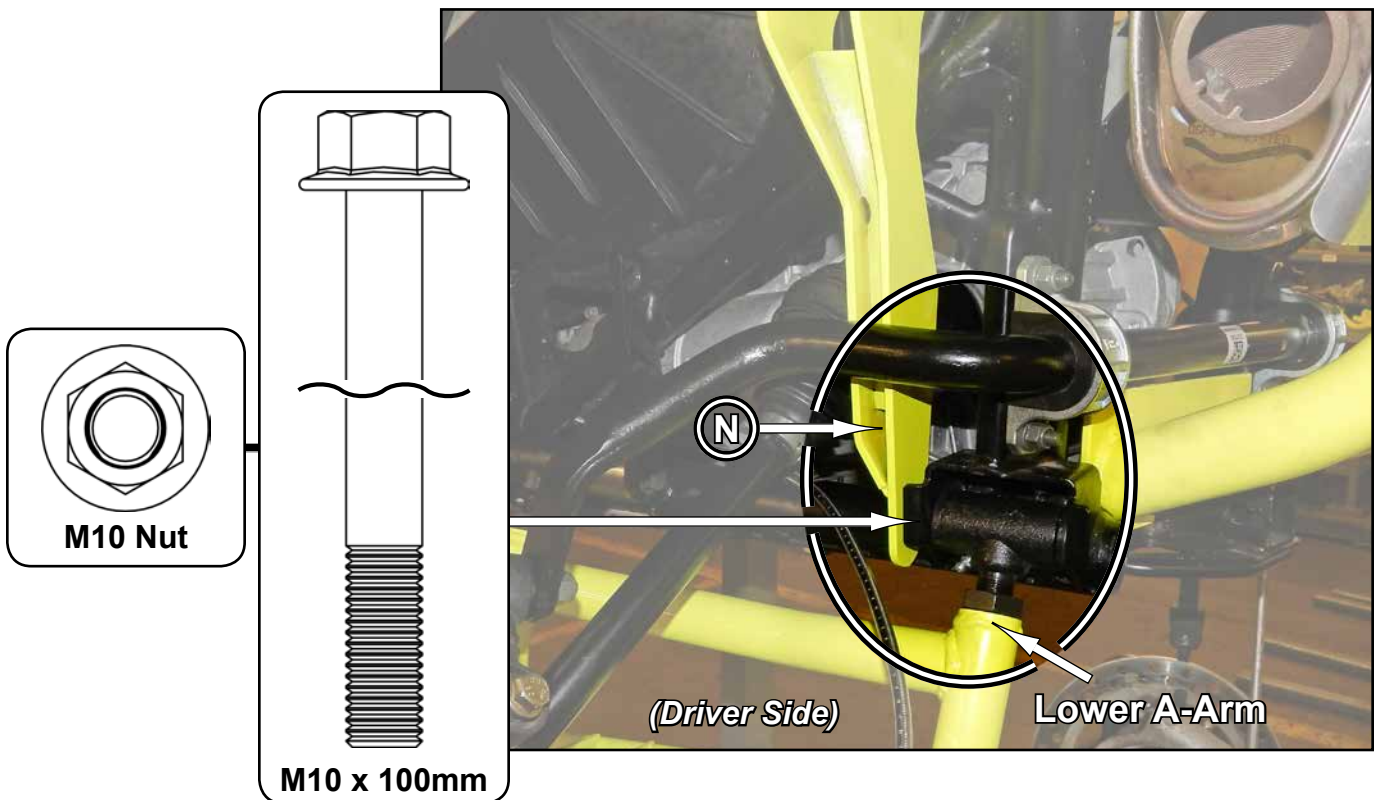
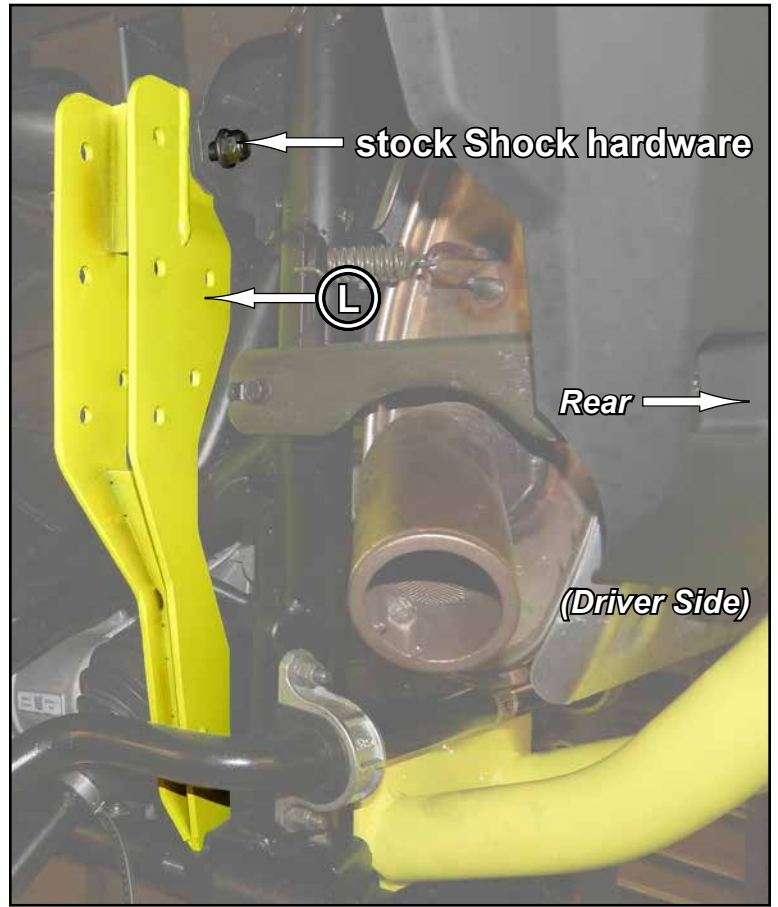
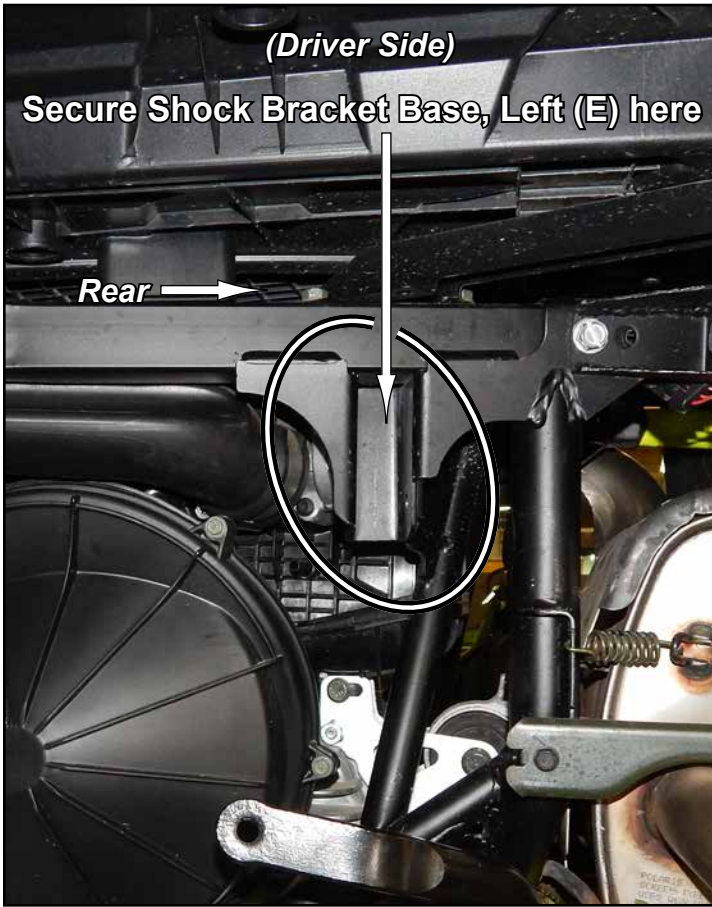

Rear Installation continued: *Do not tighten hardware completely until last step.*

- Insert Rear Shock Bracket Brace (A) through Frame from opposite side.
- Install Shock Bracket (C) into Shock Bracket Base, Left (E).
- Secure Shock Bracket (C), Shock Bracket Base, Left (E), and Rear Shock Bracket Brace (A) with hardware shown.
- Repeat for Shock Bracket Base, Right (D)
- Install new Axles.
- Connect Sway Bar Links to Lower A-Arms and reinstall Calipers, Hubs, Knuckles, etc.
- Reinstall Shocks with hardware shown.

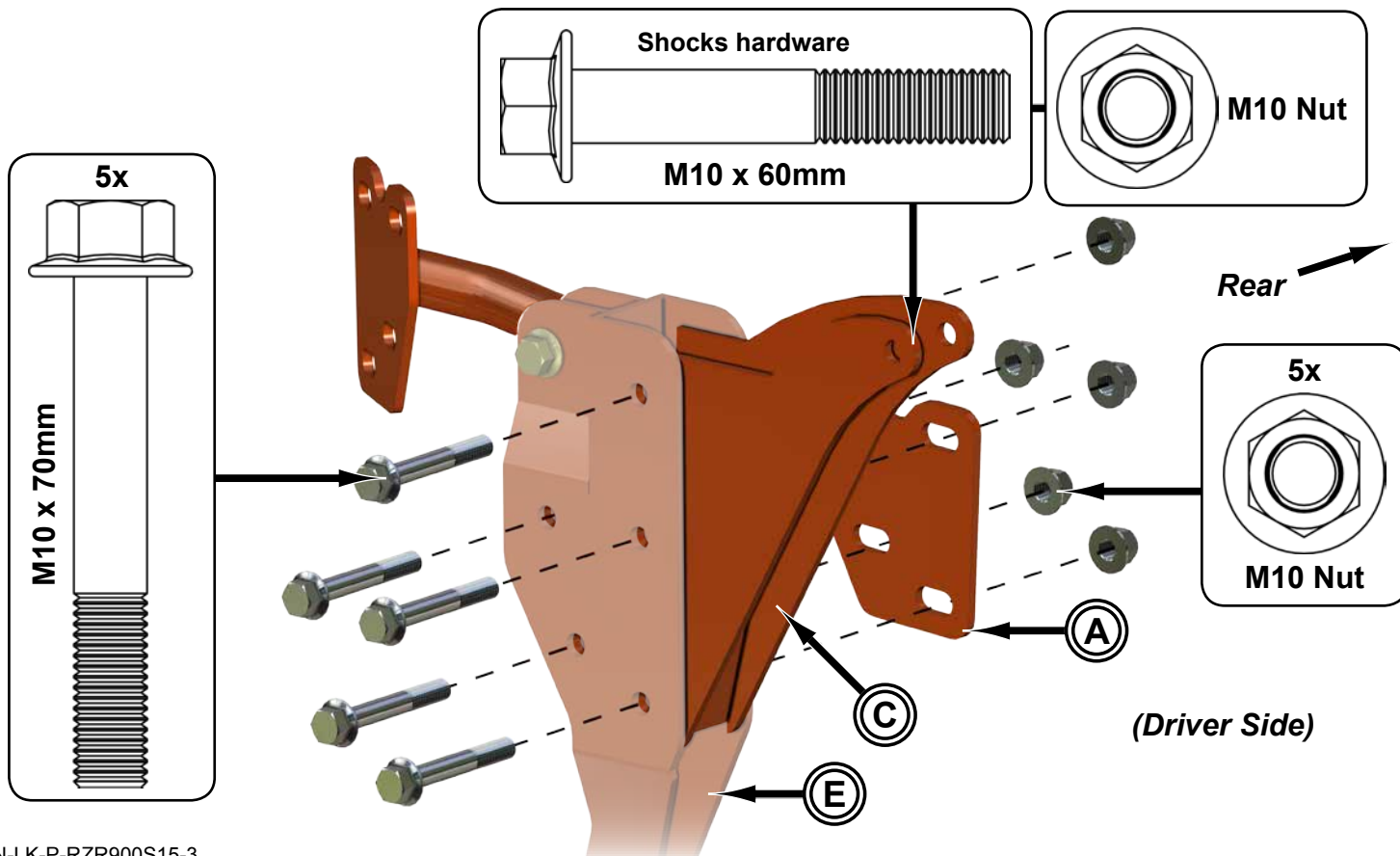
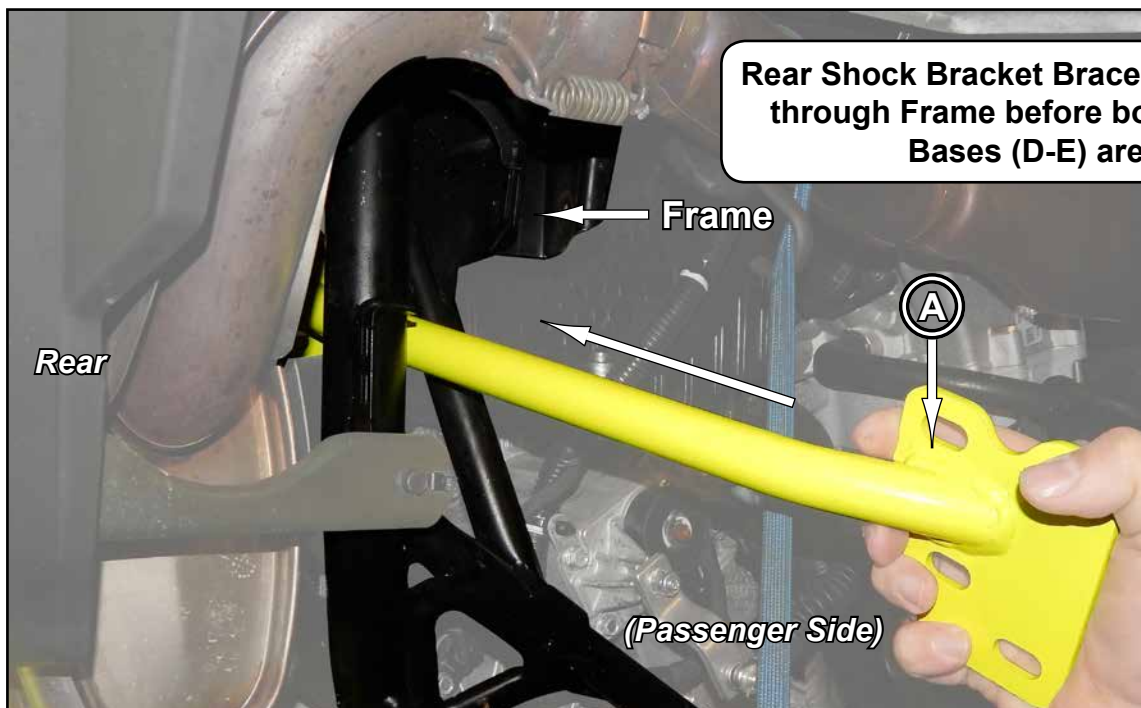

Vent Tube Rerouting:

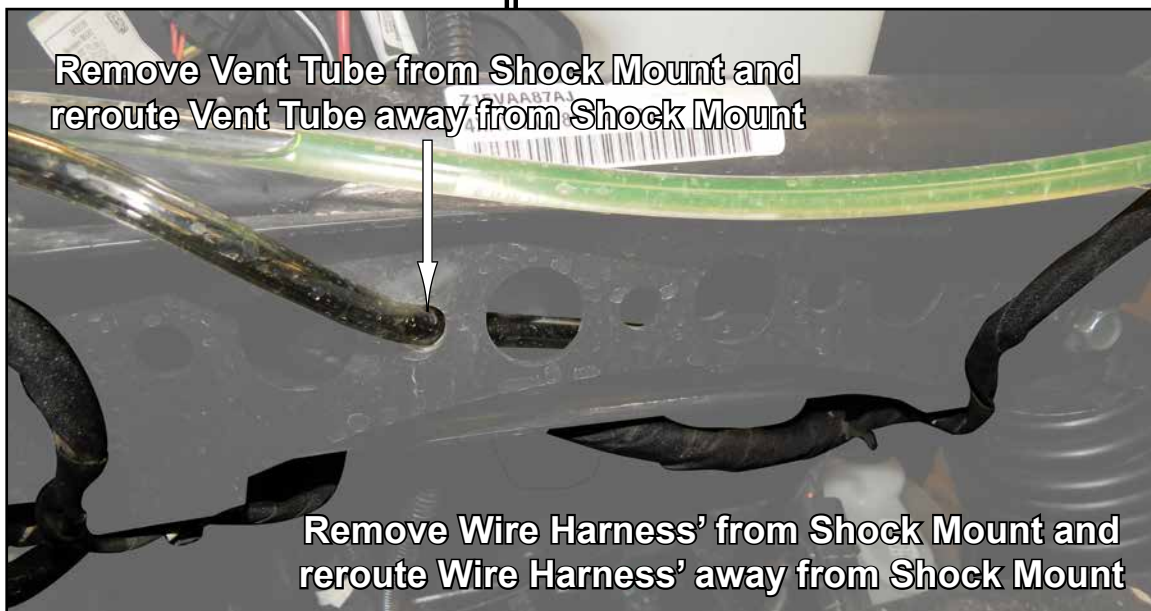
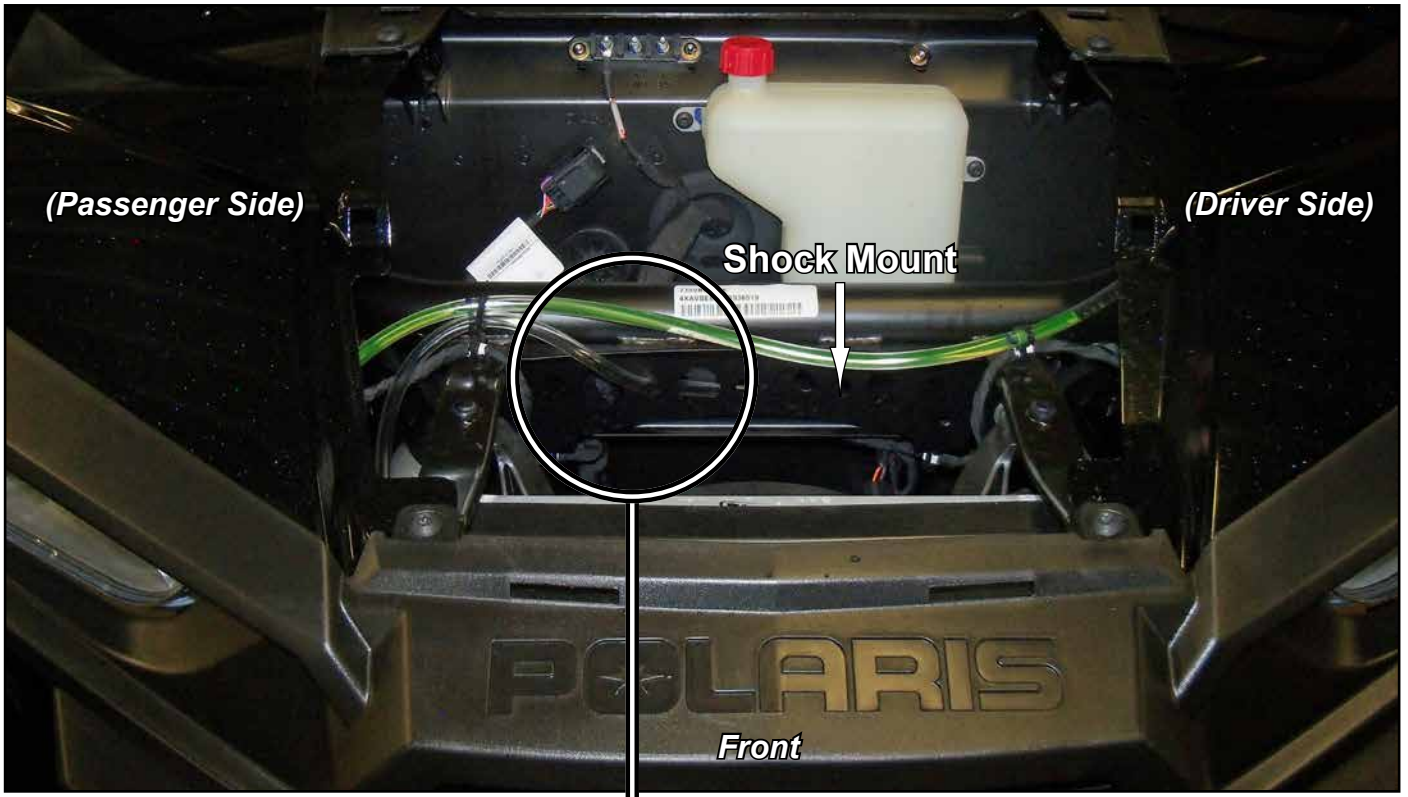

! Remove any previously installed Steering Stops. Provided Steering Stops must be installed.

Steering Stop Installation: *Rack and Pinion shown off machine for clarity*

Note: Driver Side installation is shown.

- Remove Boots from Rack and Pinion.
- Install Bushing onto Rack and Pinion shaft; repeat for opposite side.
- Reinstall Boots to Rack and Pinion with provided Wire Ties.

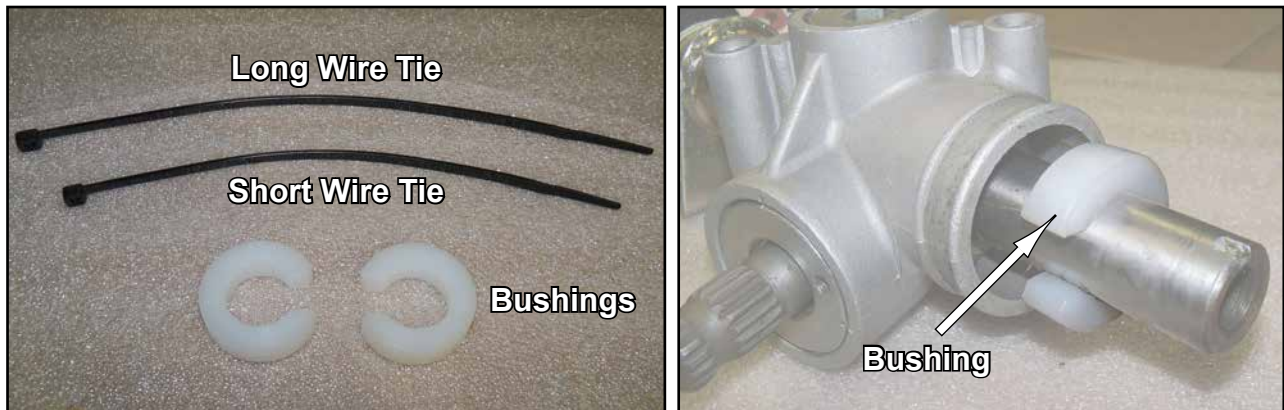

Front Installation: Do not tighten hardware completely until last step.

- Install Front Lift Bracket (B) to Shock Mount with hardware shown.
- Install new Axles.
- Reinstall Shocks to new Lift Bracket (B) with stock hardware.

