

THANK YOU FOR PURCHASING. THIS IS THE INSTALLATION MANUAL OF WALD FRONT BUMPER FOR LEXUS LX570.  
PLEASE READ THIS MANUAL CAREFULLY BEFORE THE INSTALLATION.

## ATTENTION



- ※ NO RETURNS CAN BE ACCEPTED BECAUSE OF IMPROPER INSTALLATION OR PAINTING.
- ※ CHECK THE FITMENT, AND ADJUST ALL THE DETAILS BEFORE PAINTING.
- We assume no responsibility for any damage resulting from improper installation, painting, modification and any cut wound in unsealing.
- Contact the car dealer when you have any question in removing OEM parts.
- During all the installation process, use parking brake and stop the engine completely.
- Use rasps or sandpapers to fit the products to the body if there is an individual difference.
- The product is made of FRP. Handle with care. Do not give the excessive force. Gradually fix the bolts and nuts by checking the fitment and balance of the installation.
- Check the fitment, and adjust all the details of the fitment steady and proper. Please check the fitment and all the details regularly, fix the bolts and nuts as necessary.
- The instruction of painting is just our recommendation, please paint it as you like.
- ※ PLEASE BE AWARE OF:
  - You may lose the warranty and all the services from the car maker, because of replacing OEM parts.
  - Reduced road clearance may cause inconvenience in using parking curbs and garage jack.
  - FRP, ABS and PPE products are slightly weaker than OEM parts in crashes.
  - The product may not match the body and OEM color perfectly.

Please purchase double sided tape, primer and caulking glue at auto accessory shop or hardware store.

Completely degrease and paint primer on all the installation positions to enhance the viscosity of double sided tape.  
Use dryer to warm double sided tape to enhance the viscosity in low temperature.  
Keep the car in a dry condition more than 24 hours after gluing.  
Do not wash the car during this time.

	PARTS	QUANTITIES
FRONT BUMPER	FRONT BUMPER	1
	LED LAMP	1 SET
	BOLTS (M5 x 15) FOR FOG LAMP	8

Use caulking glue to fill the gap between the product and the body.

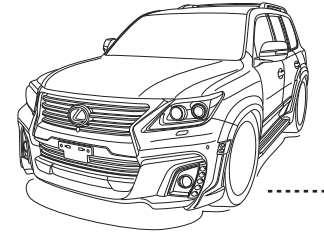

## FRONT BUMPER

### 【BEFORE PAINTING】

- 1) Remove OEM front bumper according to the Lexus service manual.
- 2) Temporarily relocate OEM PTS and head light washers to WALD Front Bumper.
- ※ Adjust the details of WALD Front Bumper to fit the body by rasps or sandpapers.
- 3) Make holes if installing OEM license plate base on WALD Front Bumper.
- 4) Paint WALD Front Bumper according to the picture.

### ■ HOW TO RELOCATE OEM HEAD LIGHT WASHER (STEP 7)

Relocate OEM washer nozzle from OEM front bumper to WALD Front Bumper.

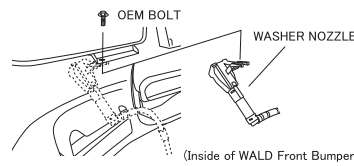

### ■ HOW TO PAINT OEM REINFORCEMENT

Paint OEM reinforcement in black not to be noticeable.

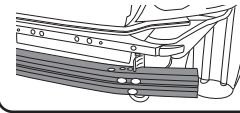

### 【AFTER PAINTING】

- 5) Fix the attached LED lamps to WALD Front Bumper.
- ※ Refer to the other installation manual.
- ※ Adjust optical axis, and make sure the LED lamps are fine to work before the installation.
- 6) Fix OEM fog lamps to WALD Front Bumper from the rear with the attached bolts.
- 7) Temporarily install WALD Front Bumper to the body after fixing all the necessary parts.
- 8) Check all the details of the fitment, then tighten with OEM clips and tapping screws.

### ■ WALD SHOWCAR IS PAINTED LIKE THE PICTURE (STEP 4)

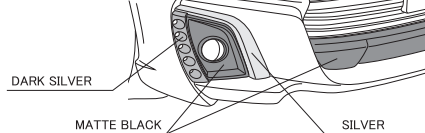

Stick-in hook part must be fixed with caulking glue to prevent OEM front grille and bumper grille coming off.

### ■ HOW TO INSTALL PTS (STEP 7)

Remove PTS and bases, then use caulking glue to fix them to WALD Front Bumper from the rear.

## ATTENTION

- ※ MORE THAN 2 TECHNICIANS ARE NECESSARY IN THIS WORK.
- ※ DURING ALL THE INSTALLATION PROCESS, PLEASE BE CAREFUL NOT TO DAMAGE THE BODY.
- ※ ADJUST ALL THE DETAILS OF WALD PRODUCTS TO FIT ON THE BODY.

OEM TAPPING SCREW

OEM CLIP

OEM FRONT GRILLE ·  
OEM BUMPER GRILLE

OEM LICENSE  
PLATE BASE

OEM HEAD LIGHT  
WASHER COVER

OEM FOG LAMP INSTALLED WITH THE ATTACHED BOLT

OEM TAPPING SCREW

ATTACHED LED LAMP

※ Use OEM resin parts to install WALD Front Bumper. (Exactly same with OEM installation process) (Inside of WALD Front Bumper)



THANK YOU FOR PURCHASING. THIS IS THE INSTALLATION MANUAL OF WALD REAR BUMPER FOR LEXUS LX570.  
PLEASE READ THIS MANUAL CAREFULLY BEFORE THE INSTALLATION.

### ATTENTION



- ※ NO RETURNS CAN BE ACCEPTED BECAUSE OF IMPROPER INSTALLATION OR PAINTING.
- ※ CHECK THE FITMENT, AND ADJUST ALL THE DETAILS BEFORE PAINTING.
- We assume no responsibility for any damage resulting from improper installation, painting, modification and any cut wound in unsealing.
- Contact the car dealer when you have any question in removing OEM parts.
- During all the installation process, use parking brake and stop the engine completely.
- Use rasps or sandpapers to fit the products to the body if there is an individual difference.
- The product is made of FRP. Handle with care. Do not give the excessive force. Gradually fix the bolts and nuts by checking the fitment and balance of the installation.
- Check the fitment, and adjust all the details of the fitment steady and proper. Please check the fitment and all the details regularly, fix the bolts and nuts as necessary.
- The instruction of painting is just our recommendation, please paint it as you like.
- ※ PLEASE BE AWARE OF:
  - You may lose the warranty and all the services from the car maker, because of replacing OEM parts.
  - Reduced road clearance may cause inconvenience in using parking curbs and garage jack.
  - FRP, ABS and PPE products are slightly weaker than OEM parts in crashes.
  - The product may not match the body and OEM color perfectly.

Please purchase double sided tape, primer and caulking glue at auto accessory shop or hardware store.

Completely degrease and paint primer on all the installation positions to enhance the viscosity of double sided tape.  
Use dryer to warm double sided tape to enhance the viscosity in low temperature.  
Keep the car in a dry condition more than 24 hours after gluing.  
Do not wash the car during this time.

	PARTS	QUANTITIES
REAR BUMPER	REAR BUMPER	1
	MESHES	2
	LED LAMP WITH NUTS	1
	REFLECTORS	1 SET
	HEXAGON SOCKET	
	HEAD CAP SCREWS (M6 x 15)	2
	BOLTS (M5 x 15)	2
	TAPPING SCREWS (M4 x 15)	6
	BRACKETS FOR MUD GUARD	2

■ HOW TO INSTALL OEM TAIL FINISHER  
TOYOTA OEM PARTS NUMBER  
52106-50030 / 52107-50030

※ Opening of OEM Tail finisher must be covered by mesh or a piece of WALD Rear Bumper.

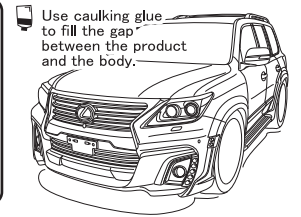

## REAR BUMPER

### 【BEFORE PAINTING】

- 1) Remove OEM rear bumper according to the Lexus service manual.
- 2) Temporarily fix WALD Rear Bumper to the body with the necessary OEM parts.
- ※ Adjust the details of WALD Rear Bumper to fit the body by rasps or sandpapers.
- 3) Fix WALD Muffler Adaptor (sold separately) to change the angle of the exhaust pipe to the ground.
- 4) Cut OEM mud-guard according to the shape of WALD Rear Bumper, then mark the positions for the attached tapping screws.
- 5) Make holes according to the marked positions after taking off WALD Rear Bumper from the body.
- 6) Paint WALD Rear Bumper according to the picture.

### 【AFTER PAINTING】

- 7) Use caulking glue to fix the attached meshes, reflectors, PTS and OEM urethane cushion on WALD Rear Bumper.
- 8) Fix the attached LED lamp on the Towing Hook Cover.
- ※ Make sure the attached LED lamp is fine to work before the installation.
- 9) Temporarily fix WALD Rear Bumper to the body with the necessary OEM parts.
- 10) Check all the details of the fitment, then fix all the OEM bolts and clips.

### ATTENTION

- ※ MORE THAN 2 TECHNICIANS ARE NECESSARY IN THIS WORK. DURING ALL THE INSTALLATION PROCESS, PLEASE BE CAREFUL NOT TO DAMAGE THE BODY.
- ※ REMOVE THE BATTERY BEFORE ALL THE WIRING WORKS.
- ※ ADJUST ALL THE DETAILS OF WALD PRODUCTS TO FIT ON THE BODY.

■ WALD SHOWCAR IS PAINTED LIKE THE PICTURE (STEP 6)

■ HOW TO INSTALL THE ATTACHED MESHES (STEP 7)  
Use pins and caulking glue to install the attached meshes to WALD Rear Bumper from the rear.

ATTACHED MESH  
MATTE BLACK METALLIC SILVER

■ HOW TO INSTALL PTS (STEP 6)

Remove PTS and bases, then use caulking glue to fix them to WALD Front Bumper from the rear.

■ HOW TO INSTALL THE ATTACHED LED LAMP (STEP 8)

(Inside of the Towing Hook Cover)

ATTACHED NUT ATTACHED LED LAMP

※Connect the harness to rear fog lamp.

OEM REAR STEP GUARD  
OEM UNDER COVER  
OEM URETHANE CUSHION  
OEM CLIP  
OEM BOLT  
TOWING HOOK COVER  
HEXAGON SOCKET HEAD CAP SCREW (M6 x 15)  
BOLT (M5 x 15)  
ATTACHED REFLECTOR  
OEM MUD-GUARD

■ HOW TO INSTALL OEM MUD-GUARD (STEP 4)  
Cut the ■ part according to WALD Rear Bumper. Use the original holes to install the attached brackets to OEM mud-guards.

ATTACHED BRACKET  
WALD Rear Bumper  
THE BODY  
TAPPING SCREW (M4 x 15)  
OEM MUD-GUARD  
Cut here.  
(Cross Section for the attached tapping screws.)

※Use caulking glue to install from the rear.

THANK YOU FOR PURCHASING. THIS IS THE INSTALLATION MANUAL OF WALD OVER FENDER FOR LEXUS LX570.  
PLEASE READ THIS MANUAL CAREFULLY BEFORE THE INSTALLATION.

## ATTENTION



- ※ NO RETURNS CAN BE ACCEPTED BECAUSE OF IMPROPER INSTALLATION OR PAINTING.
- ※ CHECK THE FITMENT, AND ADJUST ALL THE DETAILS BEFORE PAINTING.
- We assume no responsibility for any damage resulting from improper installation, painting, modification and any cut wound in unsealing.
- Contact the car dealer when you have any question in removing OEM parts.
- During all the installation process, use parking brake and stop the engine completely.
- Use rasps or sandpapers to fit the products to the body if there is an individual difference.
- The product is made of FRP. Handle with care. Do not give the excessive force. Gradually fix the bolts and nuts by checking the fitment and balance of the installation.
- Check the fitment, and adjust all the details of the fitment steady and proper. Please check the fitment and all the details regularly, fix the bolts and nuts as necessary.
- The instruction of painting is just our recommendation, please paint it as you like.
- ※ PLEASE BE AWARE OF:
  - You may lose the warranty and all the services from the car maker, because of replacing OEM parts.
  - Reduced road clearance may cause inconvenience in using parking curbs and garage jack.
  - FRP, ABS and PPE products are slightly weaker than OEM parts in crashes.
  - The product may not match the body and OEM color perfectly.

Please purchase double sided tape, primer and caulking glue at auto accessory shop or hardware store.

Completely degrease and paint primer on all the installation positions to enhance the viscosity of double sided tape.  
Use dryer to warm double sided tape to enhance the viscosity in low temperature.  
Keep the car in a dry condition more than 24 hours after gluing.  
Do not wash the car during this time.

	PARTS	QUANTITIES
OVER FENDER	OVER FENDER	1 SET
	LED LAMP	1 SET
	TAPPING SCREWS (M4 x 15)	20

Use caulking glue to fill the gap between the product and the body.

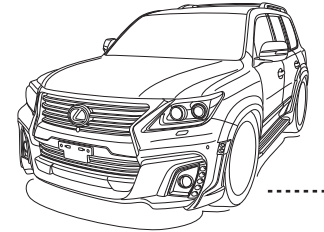

## OVER FENDER

### 【BEFORE PAINTING】

- 1) Temporarily fix the attached LED lamps to WALD Over Fender.
- ※ Adjust the details of WALD Over Fenders to fit the attached LED Lamps by rasps or sandpapers.
- 2) Mark the installation positions on the body with masking tape after checking the fitting.
- 3) Make holes on WALD Over Fenders and the body to fix the attached tapping screws.
- 4) Prepare to connect the attached LED lamps.
- ※ Insulate any spare harness.
- 5) Paint WALD Over Fenders according to the picture.

■ WALD SHOWCAR IS PAINTED LIKE THE PICTURE (STEP 5)

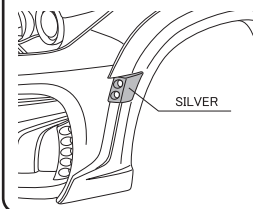

### 【AFTER PAINTING】

- 6) Completely degrease the installation positions, then use caulking glue to fix the attached LED lamps.
- ※ Make sure the attached LED lamps are fine to work before the installation.
- 7) Completely degrease the installation positions, then use caulking glue to install WALD Over Fenders to the body.
- 8) Connect the harness of the attached LED lamps, then tighten the attached tapping screws.
- 9) Leave them till completely fixed.

■ HOW TO INSTALL THE ATTACHED LED LAMPS (STEP 1, 6)

LED LAMP (Face of the lens)



Use heat resistant caulking glue to fix the attached LED lamps on WALD Front Bumper according to the picture.

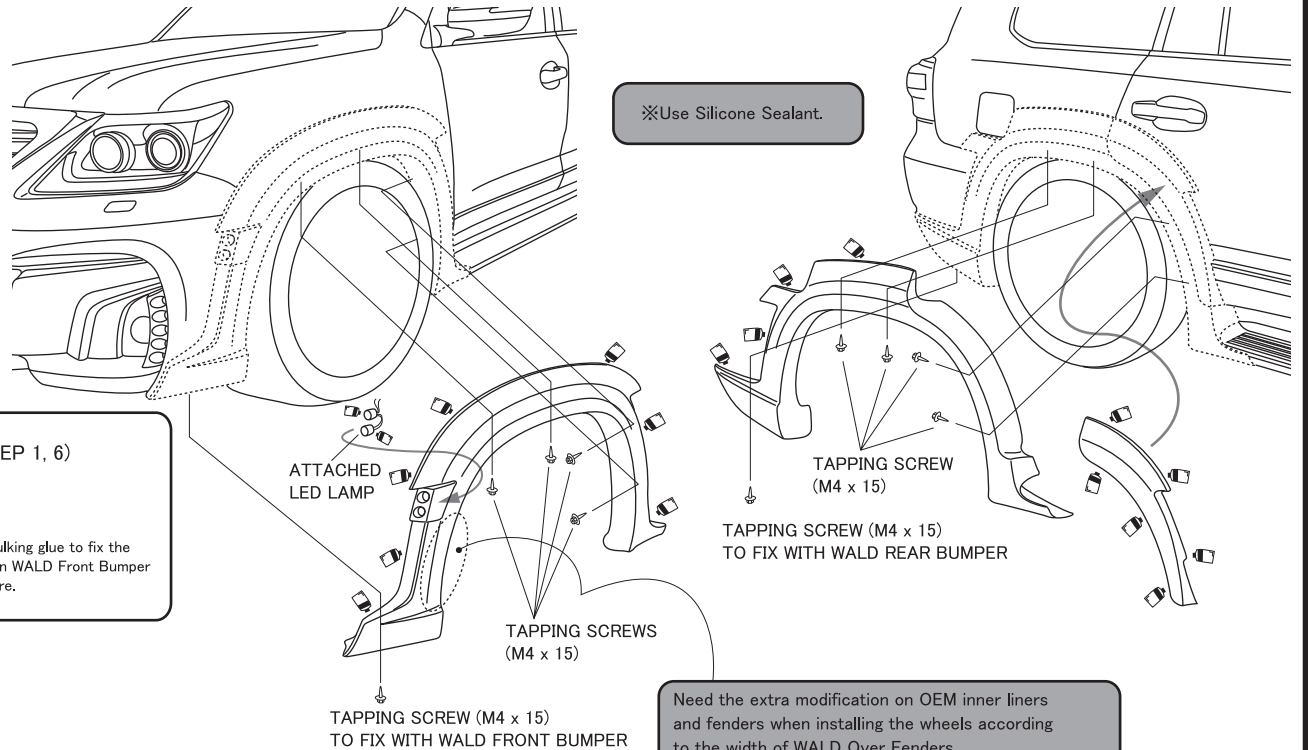

## ATTENTION

- ※ MORE THAN 2 TECHNICIANS ARE NECESSARY IN THIS WORK.
- DURING ALL THE INSTALLATION PROCESS, PLEASE BE CAREFUL NOT TO DAMAGE THE BODY.
- ※ REMOVE THE BATTERY BEFORE ALL THE WIRING WORKS.
- ※ ADJUST ALL THE DETAILS OF WALD PRODUCTS TO FIT ON THE BODY.

THANK YOU FOR PURCHASING. THIS IS THE INSTALLATION MANUAL OF LED LAMPS ON WALD FRONT BUMPER FOR LEXUS LX570  
PLEASE READ THIS MANUAL CAREFULLY BEFORE THE INSTALLATION.

## ATTENTION



- ※ NO RETURNS CAN BE ACCEPTED BECAUSE OF IMPROPER INSTALLATION OR PAINTING.
- ※ CHECK THE FITMENT, AND ADJUST ALL THE DETAILS BEFORE PAINTING.
- We assume no responsibility for any damage resulting from improper installation, painting, modification and any cut wound in unsealing.
- Contact the car dealer when you have any question in removing OEM parts.
- During all the installation process, use parking brake and stop the engine completely.
- Use rasps or sandpapers to fit the products to the body if there is an individual difference.
- The product is made of FRP. Handle with care. Do not give the excessive force. Gradually fix the bolts and nuts by checking the fitment and balance of the installation.
- Check the fitment, and adjust all the details of the fitment steady and proper. Please check the fitment and all the details regularly, fix the bolts and nuts as necessary.
- The instruction of painting is just our recommendation, please paint it as you like.
- ※ PLEASE BE AWARE OF:
  - You may lose the warranty and all the services from the car maker, because of replacing OEM parts.
  - Reduced road clearance may cause inconvenience in using parking curbs and garage jack.
  - FRP, ABS and PPE products are slightly weaker than OEM parts in crashes.
  - The product may not match the body and OEM color perfectly.

Please purchase double sided tape, primer and caulking glue at auto accessory shop or hardware store.

Completely degrease and paint primer on all the installation positions to enhance the viscosity of double sided tape.  
Use dryer to warm double sided tape to enhance the viscosity in low temperature.  
Keep the car in a dry condition more than 24 hours after gluing.  
Do not wash the car during this time.

	PARTS	QUANTITIES
LED LAMP	LED LAMP	1 SET

Use caulking glue to fill the gap between the product and the body.

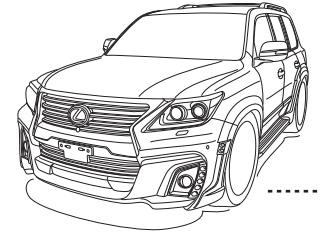

## LED LAMP

### [BEFORE PAINTING]

- 1) Temporarily fix the attached LED lamps according to the guide-line walls on WALD Front Bumper.
- ※ Adjust the details of WALD Front Bumper to fit the attached LED lamps by rasps or sandpapers.
- 2) Prepare to connect the attached LED lamps.
- ※ Insulate any spare harness.

### [AFTER PAINTING]

- 3) Completely degrease the installation positions, then put the attached LED lamps according to the guide-line walls on WALD Front Bumper.
- 4) Use caulking glue to fix the attached LED lamps after checking the angle and location.
- 5) Leave them till completely fixed.
- 6) Install WALD Front Bumper to the body after connecting the harness.

### ■ HOW TO INSTALL THE ATTACHED LED LAMPS (STEP 1, 3)

LED LAMP (Face of the lens)



Use heat resistant caulking glue to fix the attached LED lamps on WALD Front Bumper according to the picture.

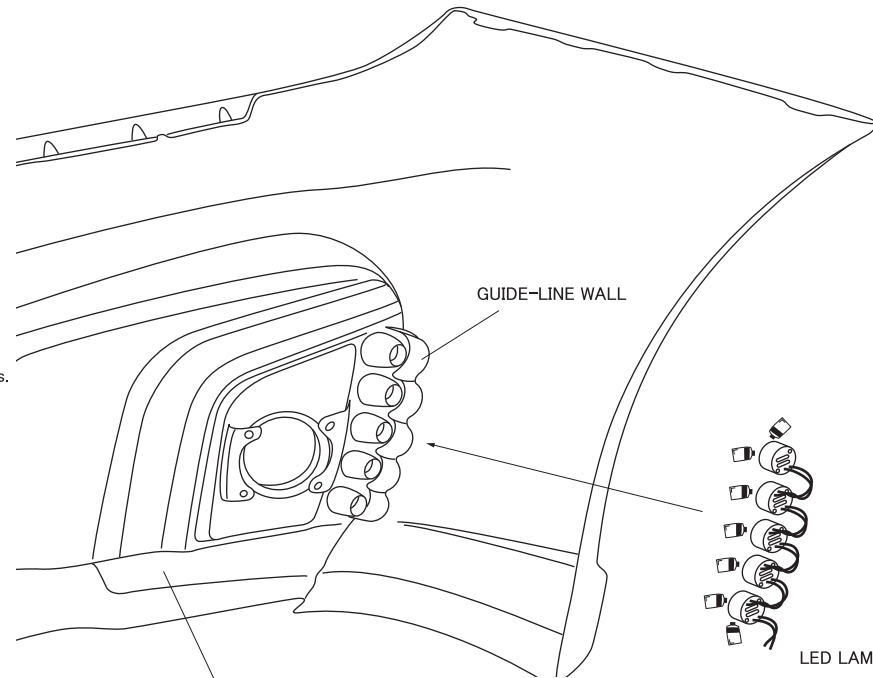

(Inside of WALD Front Bumper)

### = WIRING DIAGRAM =

[ AS DAYLIGHT ]

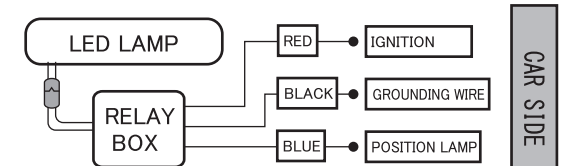

※Insulate OEM fog lamp harness.

## ATTENTION

- ※ REMOVE THE BATTERY BEFORE ALL THE WIRING WORKS.
- ※ MAKE SURE OEM FOG LAMPS ARE FINE TO WORK BEFORE THE INSTALLATION.