

TM

Tru Trac

Small Block Chevrolet
Installation Manual
For Systems Without A/C
#13225 / #13125

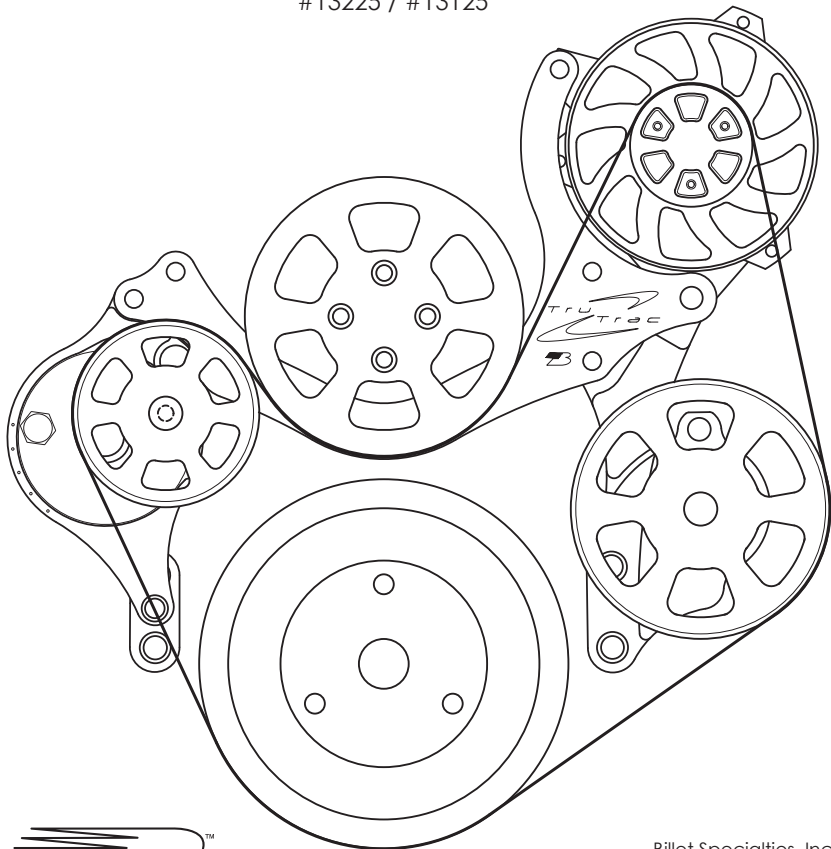

Billet Specialties, Inc.
500 Shawmut Avenue
La Grange, Illinois 60526
Tech Line (708) 588-0505
Fax (708) 588-7181

PLEASE READ ALL INSTRUCTIONS BEFORE INSTALLING ANY COMPONENTS OF THE TRU TRAC SERPENTINE SYSTEM

Required Tools & Materials

- | | | |
|---|--|--------------------------------------|
| <input type="checkbox"/> Anti-seize Compound | <input type="checkbox"/> 5/8" Combo Wrench | <input type="checkbox"/> 3/16" Allen |
| <input type="checkbox"/> RTV Silicone | <input type="checkbox"/> 9/16" Combo Wrench | <input type="checkbox"/> 5/16" Allen |
| <input type="checkbox"/> Loc-Tite® Thread Locker | <input type="checkbox"/> 11/16" Combo Wrench | <input type="checkbox"/> 1/4" Allen |
| <input type="checkbox"/> Gasket Scraper | <input type="checkbox"/> 3/4" Combo Wrench | <input type="checkbox"/> 6mm Allen |
| <input type="checkbox"/> Scotch-Brite® Pad | <input type="checkbox"/> Socket Wrench & Extension | |
| <input type="checkbox"/> 3/8-16 Thread Chaser* & Holder | <input type="checkbox"/> 10mm 12pt. socket | |
| <small>*Thread chasers are available at your local parts store and are different from a thread cutting tap.</small> | <input type="checkbox"/> 12mm 12pt. socket | |

TECH TIP:

Billet Specialties recommends the use of Anti-Seize on all fasteners to prevent thread lock-up.

Skin Board #1 - Packaged With Power Steering Pump

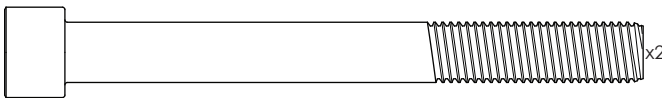

5/16-24 x 3" Socket Head Cap Screw
(Power Steering Pump)

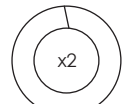

5/16"
Lock Washer

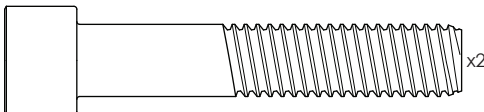

3/8-16 x 2" Socket Head Cap Screw
(Power Steering Bracket)

Prepping the block:

- Disconnect the battery.
- Remove the existing alternator, air conditioning compressor and associated brackets.
- Remove all pulleys and water pump.
- Remove all traces of gasket and sealer with gasket scraper and Scotch Brite® pad.
- Clean threads in block by chasing with a 3/8-16 thread chaser.

Skin Board #2 - Packaged With Water Pump

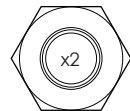

3/8-16 Zinc Coated
Hex Nuts
(Discard After Use)

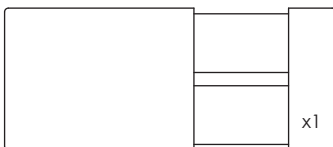
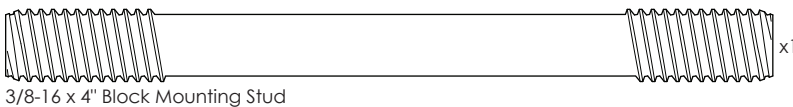

Spacer Nut - 1-3/4"



Spacer Nut - 2-11/16"

Skin Board #3 - Packaged In Main Box

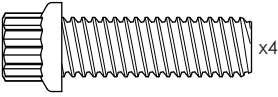

8mm-1.25 x 25mm 12pt. Cap Screw
(Bridge Bracket)

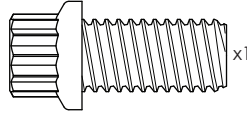

3/8-16 x 3/4" 12pt. Cap Screw
(Tensioner Pulley)

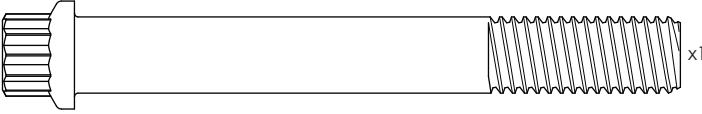

10mm-1.25 x 80mm 12pt. Cap Screw
(Alternator)

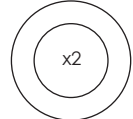

10mm x .5mm
Shim Washer

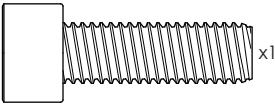

8mm-1.25 x 25mm Socket Head Cap Screw
(Tensioner)

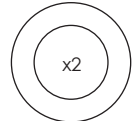

10mm x 1mm
Shim Washer

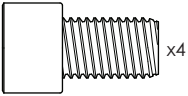

5/16-24 x 1/2" Socket Head Cap Screw
(Water Pump Pulley)

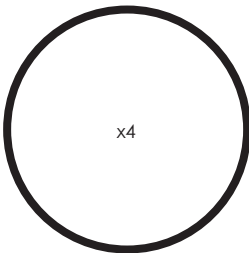

O-Ring Set



O-Ring Set

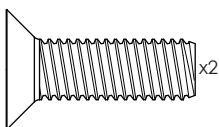

8mm-1.25 x 25mm Flat Head Cap Screw
(Bridge Bracket To Tensioner)

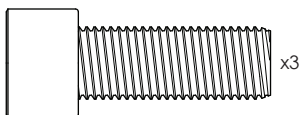

3/8-24 x 1" Socket Head Cap Screw
(Crankshaft Pulley)

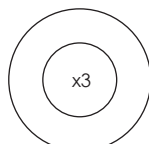

3/8" Bellville Washer

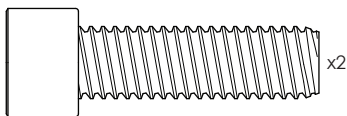

3/8-16 x 1-1/4" Socket Head Cap Screw
(Alternator Bracket)

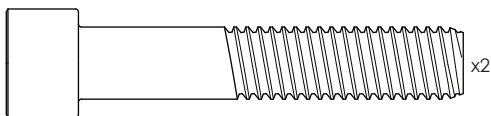

3/8-16 x 2" Socket Head Cap Screw
(Tensioner Bracket)

Other Hardware - Packaged With Power Steering Pump

Continental Elite Poly-V Serpentine Belt - 50.5" #4060505 (with power steering)

Continental Elite Poly-V Serpentine Belt - 48.5" #4060485 (without power steering)

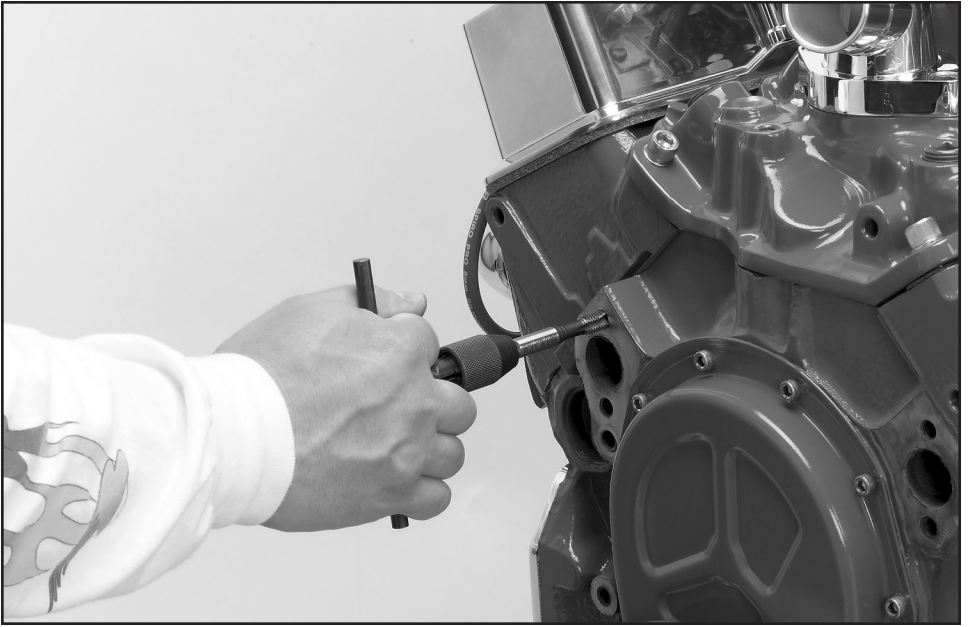
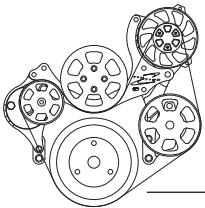

Figure 1: Prepping The Block

To ease installation of the studs and fasteners, chase the water pump mounting threads and the threads on the two lower bosses on either side of the balancer with a 3/8"-16 tap.



TRU
Trac

BilletSpecialties

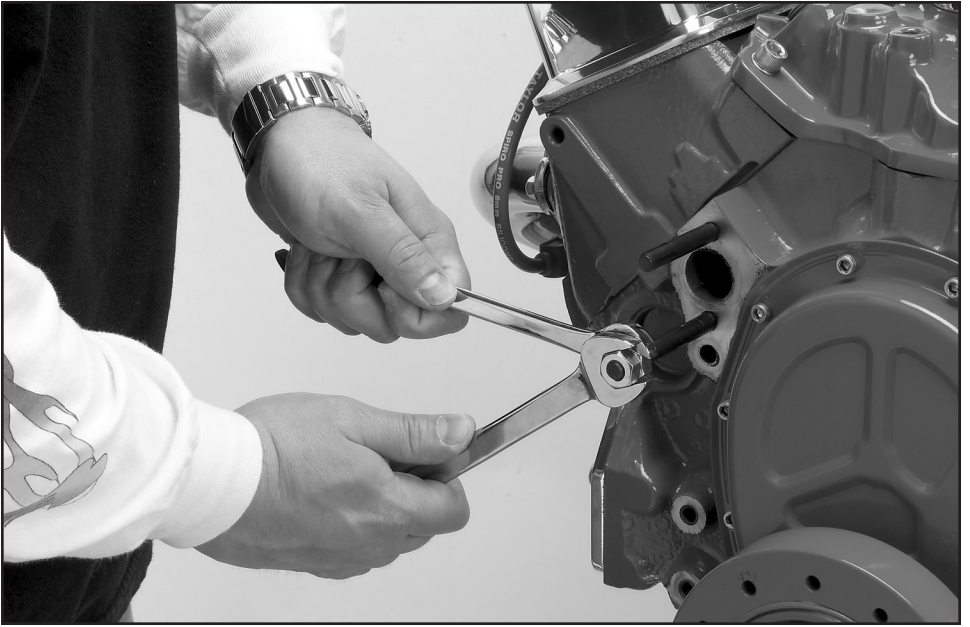
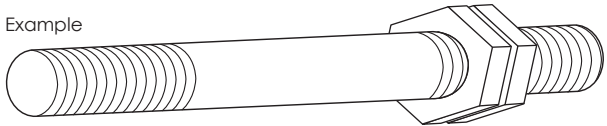

Figure 2: Install Mounting Studs

Install the four studs until the threads are completely screwed into the block. Use the two included 3/8-16 nuts tightened against each other to act as a drive nut to ease installation (see illustration below). Use an RTV silicone sealant on the threads and seat them firmly into the block.

Example



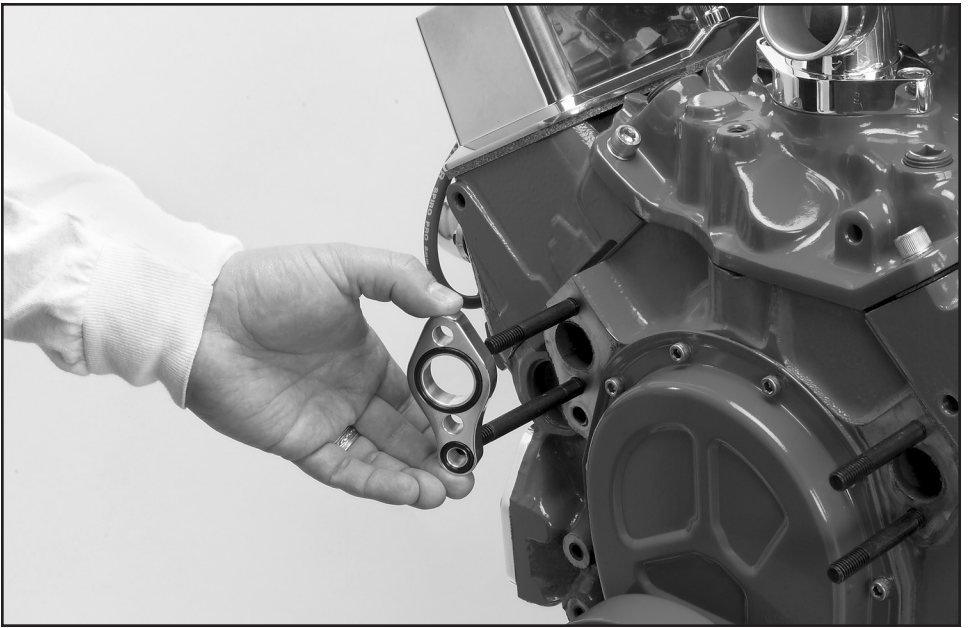
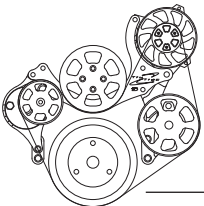

Figure 3: Install O-Rings & Water Pump Spacer

The water pump spacer and alternator mounting bracket incorporate o-rings for sealing. Install o-rings on both sides of brackets making sure to install the two small bypass o-rings on the water pump spacer bracket. Slide the water pump spacer onto the water pump studs on passenger side of block and seat against block.



TRU
Trac

Billet Specialties

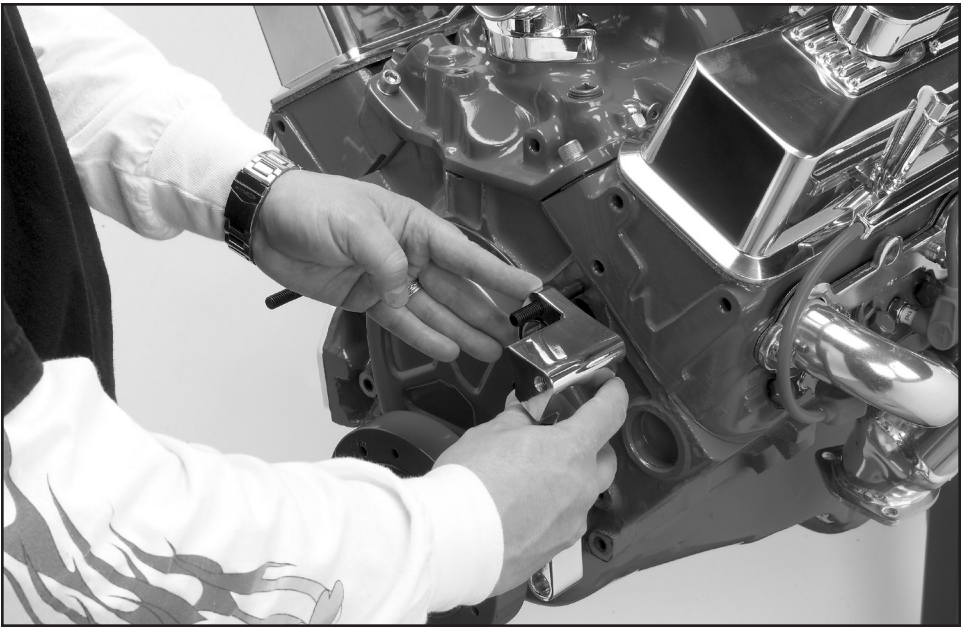

Figure 4: Install Alternator Bracket

Slide alternator bracket on to water pump studs on driver side of block and seat against block.



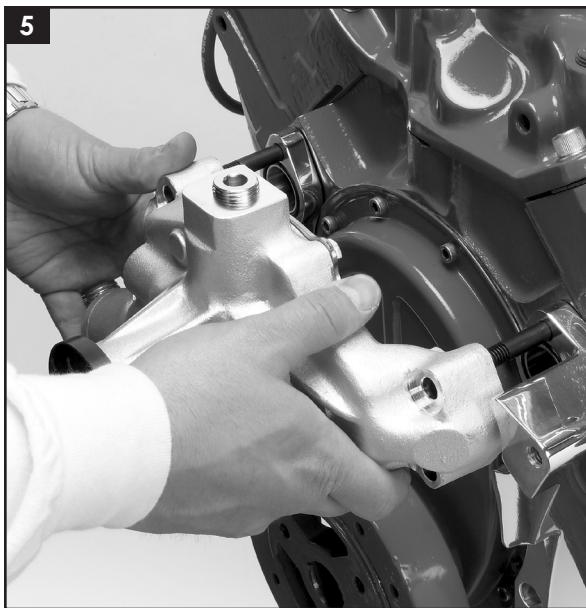

Figure 5: Install Water Pump

Slide the water pump over the four mounting studs.

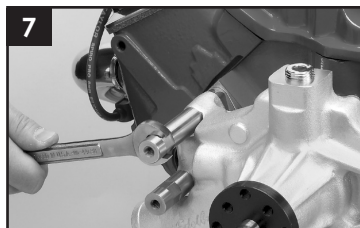
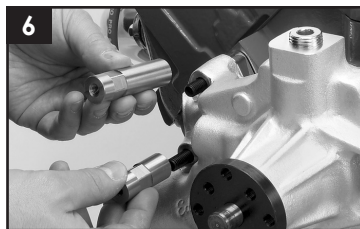
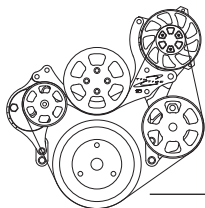

Figure 6: Install Spacer Nuts to Water Pump

Install the four spacer nuts that hold the water pump in place. The short spacer nut attaches to the passenger side lower stud.

Figure 7: Complete Water Pump Install

Tighten the four spacer nuts that hold the water pump in place. Now would be a good time to install the heater hose fitting onto the water pump.



TRU
Trac

BilletSpeedDies

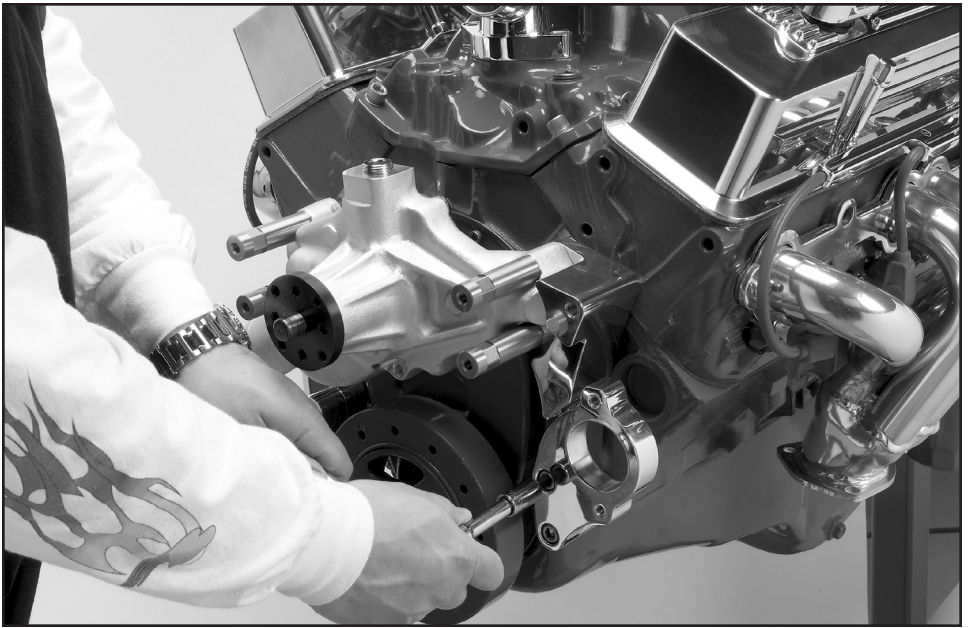

Figure 8: Install Power Steering Bracket

If your kit does not include power steering, now is the time to install the two 3/8-16 x 1-1/4" socket head cap screws on the lower end of the alternator bracket. If your kit does include power steering, install the power steering bracket using two 3/8-16 x 2" socket head cap screws on the lower end of the alternator bracket.



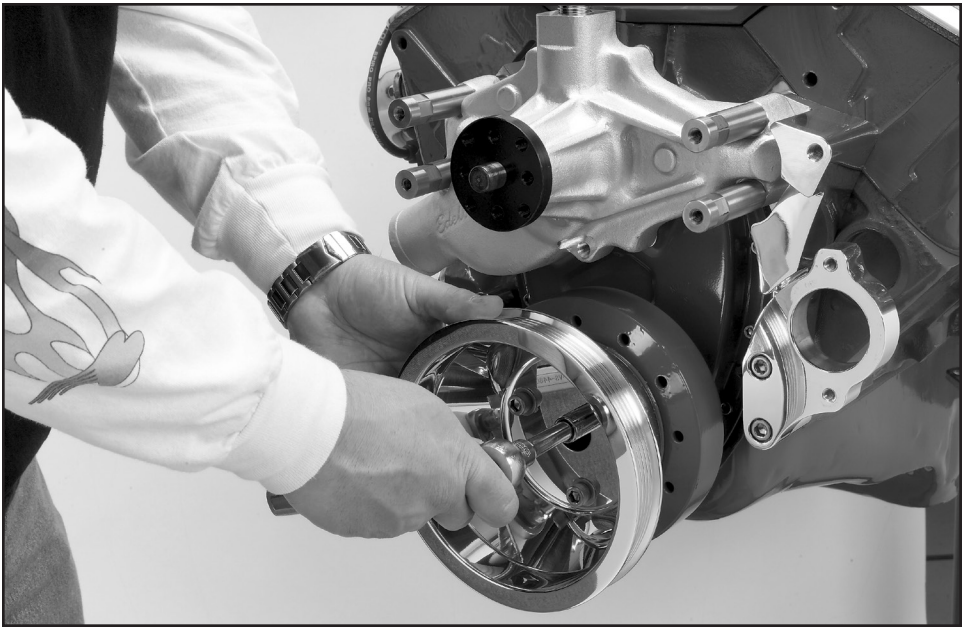
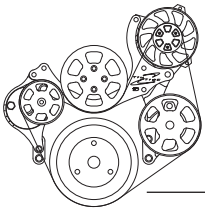

Figure 9: Install Crankshaft Pulley

Install the crankshaft pulley on the harmonic balancer using three 3/8-24 x 1" socket head cap screws and three 3/8" Belleville washers. Torque to 35 ft-lb.



TRU
Trac

Billet Specialties

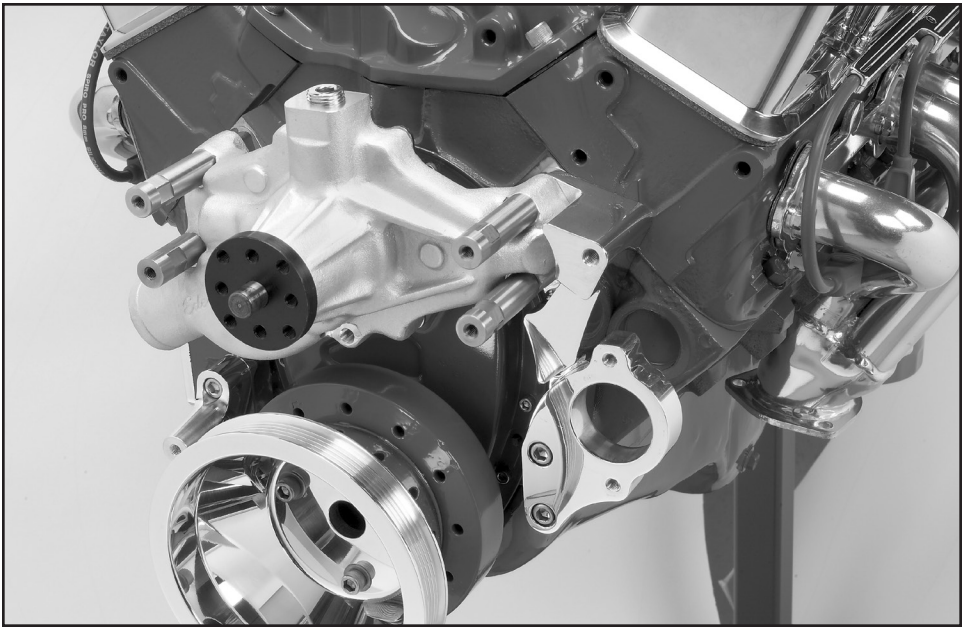

Figure 10: Install Lower Tensioner Bracket

Install the lower tensioner support bracket using two 3/8-16 x 2" socket head cap screws to the two threaded bosses on the lower passenger side of the block.



Figure 11: Install Power Steering Pump & Pulley

If your kit does include power steering, attach the power steering pump and pulley to the power steering bracket using two 5/16-24 x 3" socket head cap screws & two 5/16" lock washers. If your kit does not use power steering proceed to figure 12.

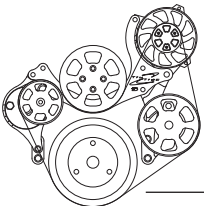

TRU
Trac *Billet Specialties*

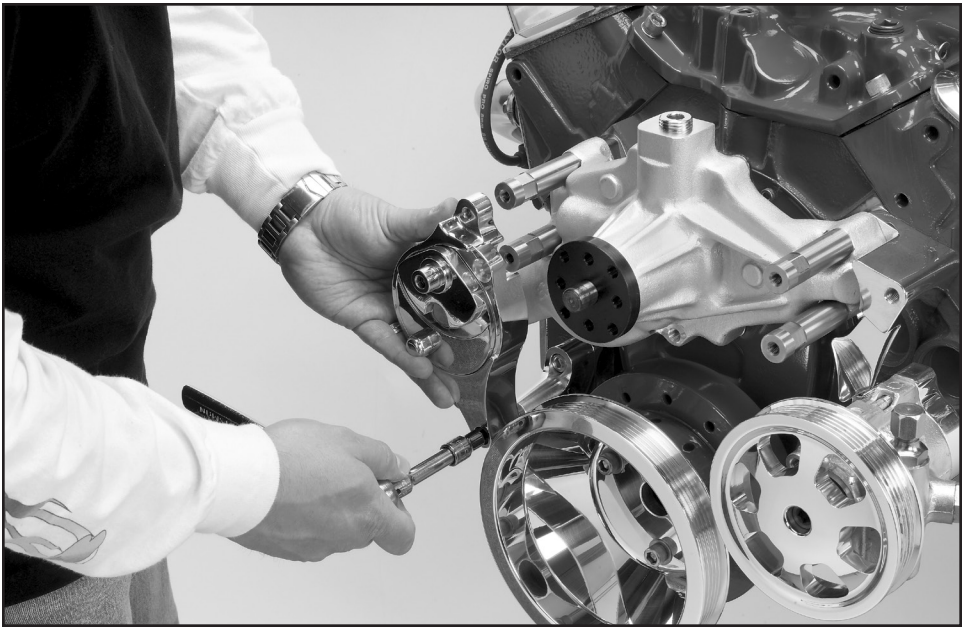

Figure 12: Install Belt Tensioner

Install the belt tensioner to the tensioner support bracket and the lower water pump spacer nut using one 8mm-1.25 x 25mm socket head cap screw and one 8mm-1.25 x 25mm flat head cap screw.

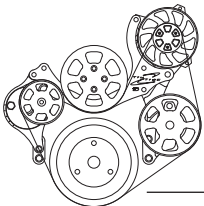

Figure 13: Install Bridge Bracket

Install the bridge bracket to the three water pump spacer nuts and the tensioner housing using three 8mm-1.25 x 25mm 12 pt. cap screws and one 8mm-1.25 x 25mm flat head cap screw.

Figure 14: Bridge Bracket Tightening Instructions

Tighten the 8mm-1.25 x 25mm flat head cap screw and the 8mm-1.25 x 25mm 12 pt. cap screw on the passenger side of the bracket. Do not tighten the two 8mm-1.25 x 25mm 12 pt. cap screws on the driver side of the bracket at this time.



TRU
Trac

Billet Speed Dies



Figure 15: Install Water Pump Pulley

Install the water pump pulley on the water pump using four 5/16-24 x 1/2" socket head cap screws.



Figure 16: Installation Checkpoint

The system is now ready to install the tensioner pulley and alternator.

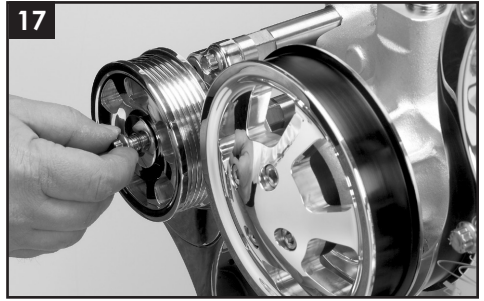

Figure 17: Install Tensioner Pulley

Install the tensioner pulley and aluminum load washer to the tensioner using a 3/8-16 x 3/4" 12 pt. cap screw.

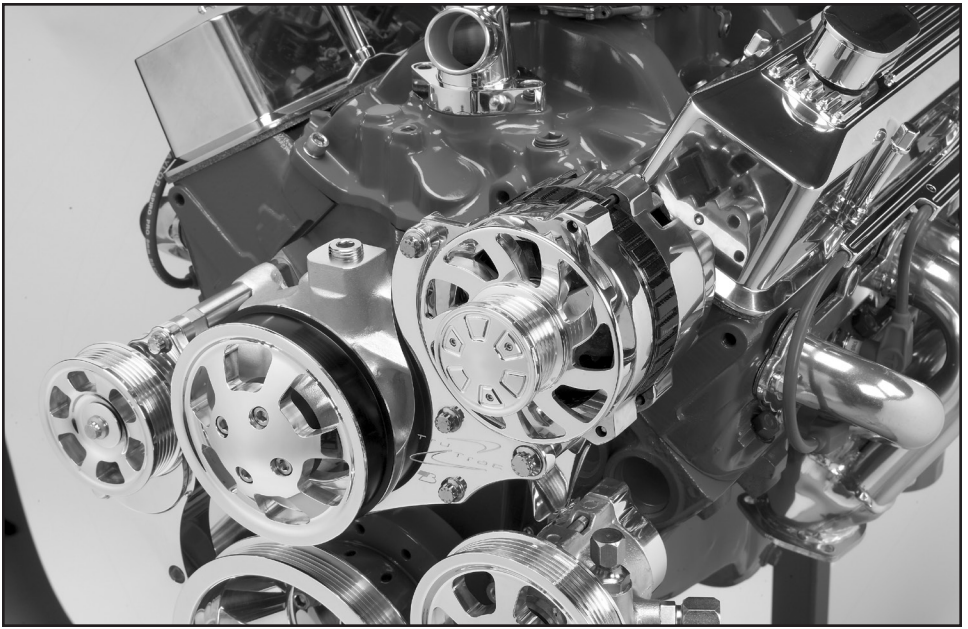
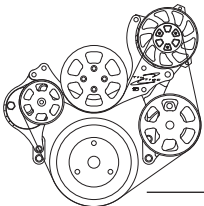

Figure 18: Install Alternator

Install the 10mm-1.5 x 80mm 12 pt. cap screw in the lower alternator mounting hole and the 8mm-1.25 x 25mm 12pt. cap screw in the top ear of the alternator. 10mm shim washers are provided to shim alternator to bridge bracket if needed. The alternator mounting boss may vary in width in the polishing process.



TRU
Trac

Billet Specialties

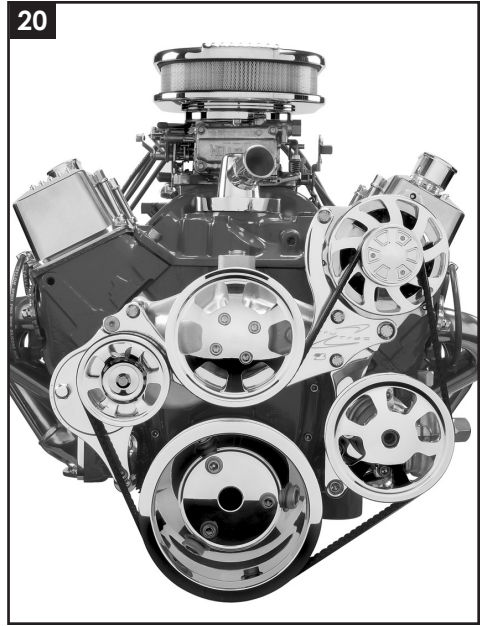
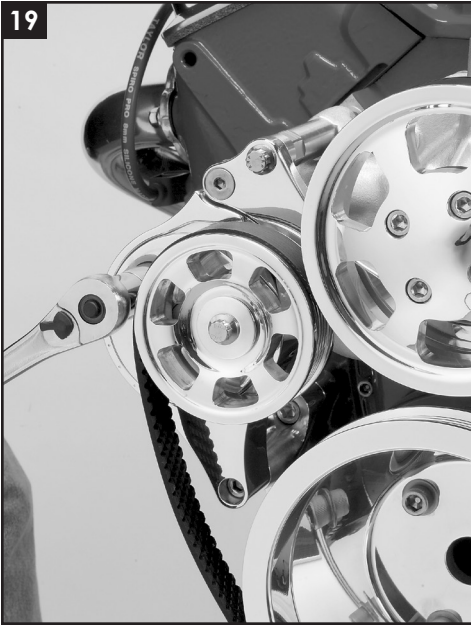

Figure 19: Install Serpentine Belt

With a 5/8" six point socket or box wrench, turn the belt tensioner release nut clockwise to unload the spring and install the serpentine belt.

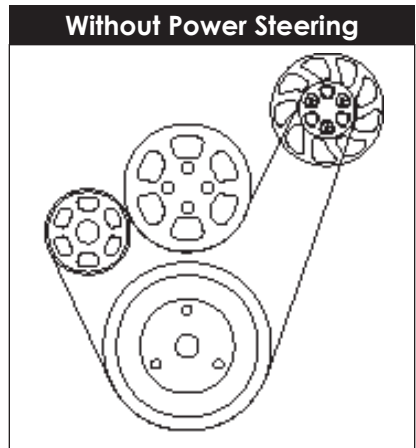
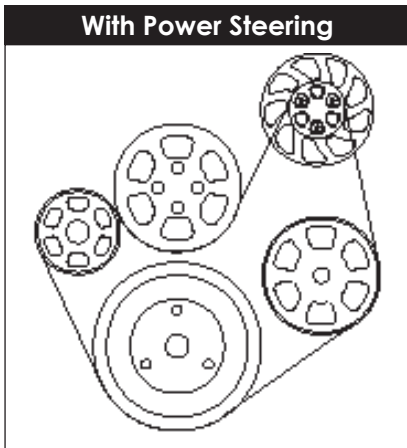

Figure 20: System Complete

The system is complete and ready for alternator wiring and power steering hoses. A Billet Specialties power steering remote reservoir is available in smooth (77910) or ribbed (77920) styles.



Billet Specialties, Inc.
500 Shawmut Avenue
La Grange, Illinois 60526
Tech Line (708) 588-0505
Fax (708) 588-7181
www.billet specialties.com

