

advanced FLOW engineering Super Stock Air Intake System

Instruction Manual P/N: 55-10014DC / 55-10014RC

Make: RAM

Model: 1500 TRX

Year: 2021-2023

Engine: V8-6.2L (sc)



- Please read the entire instruction manual before proceeding.
- Ensure all components listed are present.
- For technical support please call 951-493-7185.
- Ensure you have all necessary tools before proceeding.
- Do not attempt to work on your vehicle when the engine is hot.
- Retain factory parts for future use.

Label	Qty.	Description	Part Number
A1	2	Air Filter (Pro 5R)	30-10401R
A2	2	Air Filter (Pro DRY S)	30-10401D
B	1	Carbon Fiber Tube	05-5510014C1
C	1	Coupling, Silicone Bellow: (108mmx100mm)ID x 3"L	05-01703
D	1	Coupling, Silicone Hump: 5"ID x 3"L	05-01255
E	1	Clamp, T-bolt (3-13/16" - 4-1/8") (SS)	03-50265
F	1	Clamp, T-bolt (4-5/16"-4-5/8") (SS)	03-50499
G	2	Clamp, T-bolt (5-5/16"-5-5/8") (SS)	03-50291
H	1	Hose, Silicone Breather: 1/2" ID, Black (10" L)	05-01396

Installation will require the following tools:

Trim removal tool, 8mm, 10mm, 11mm deep, and 13mm sockets, 6" ratchet extension, ratchet, razor blade.

Warranty Information available at <https://afepower.com/contact#warranty>

Emissions Disclaimer: This product is not currently CARB exempt and is not available for purchase in California or for use on any vehicle registered with the California Department of Motor Vehicles.

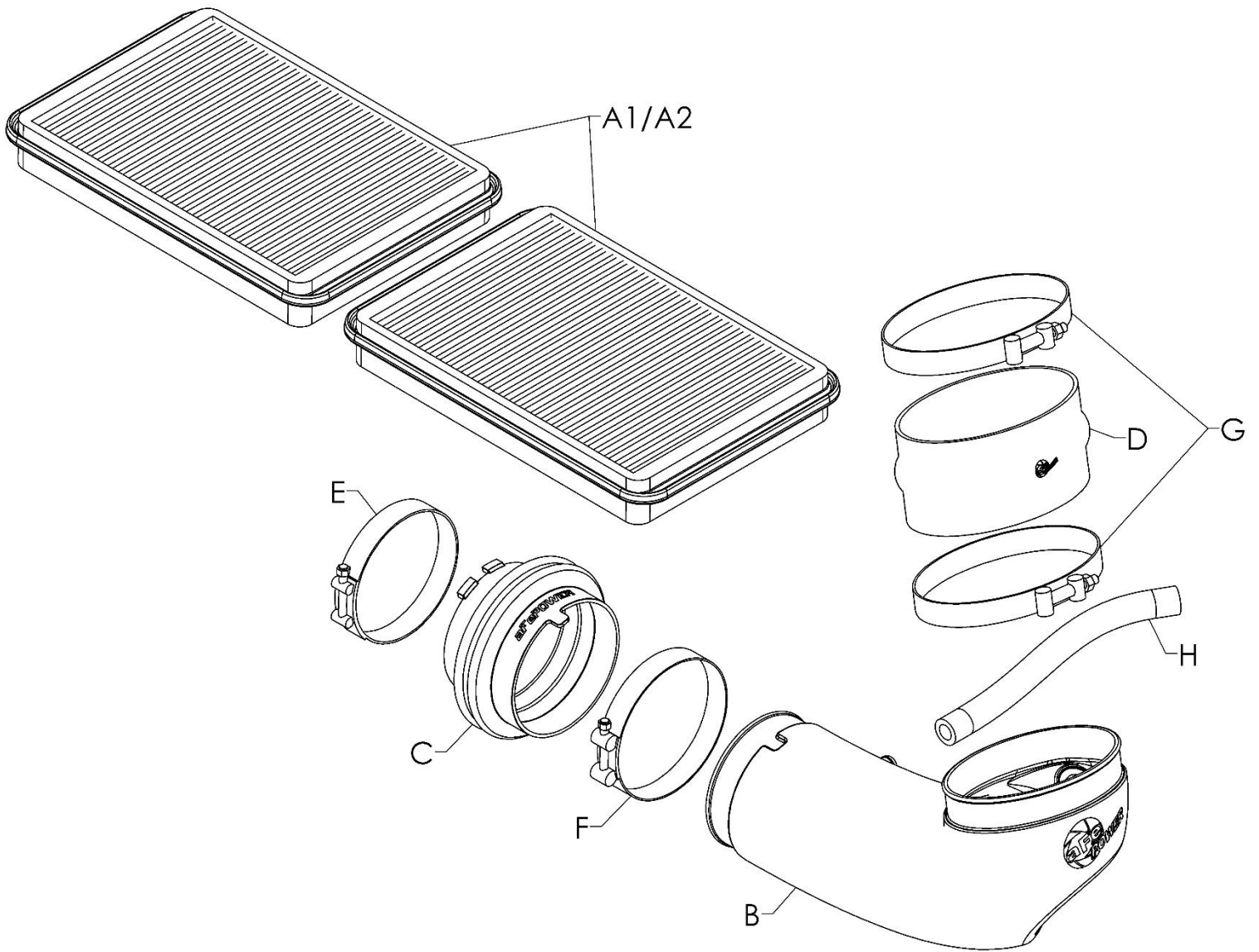

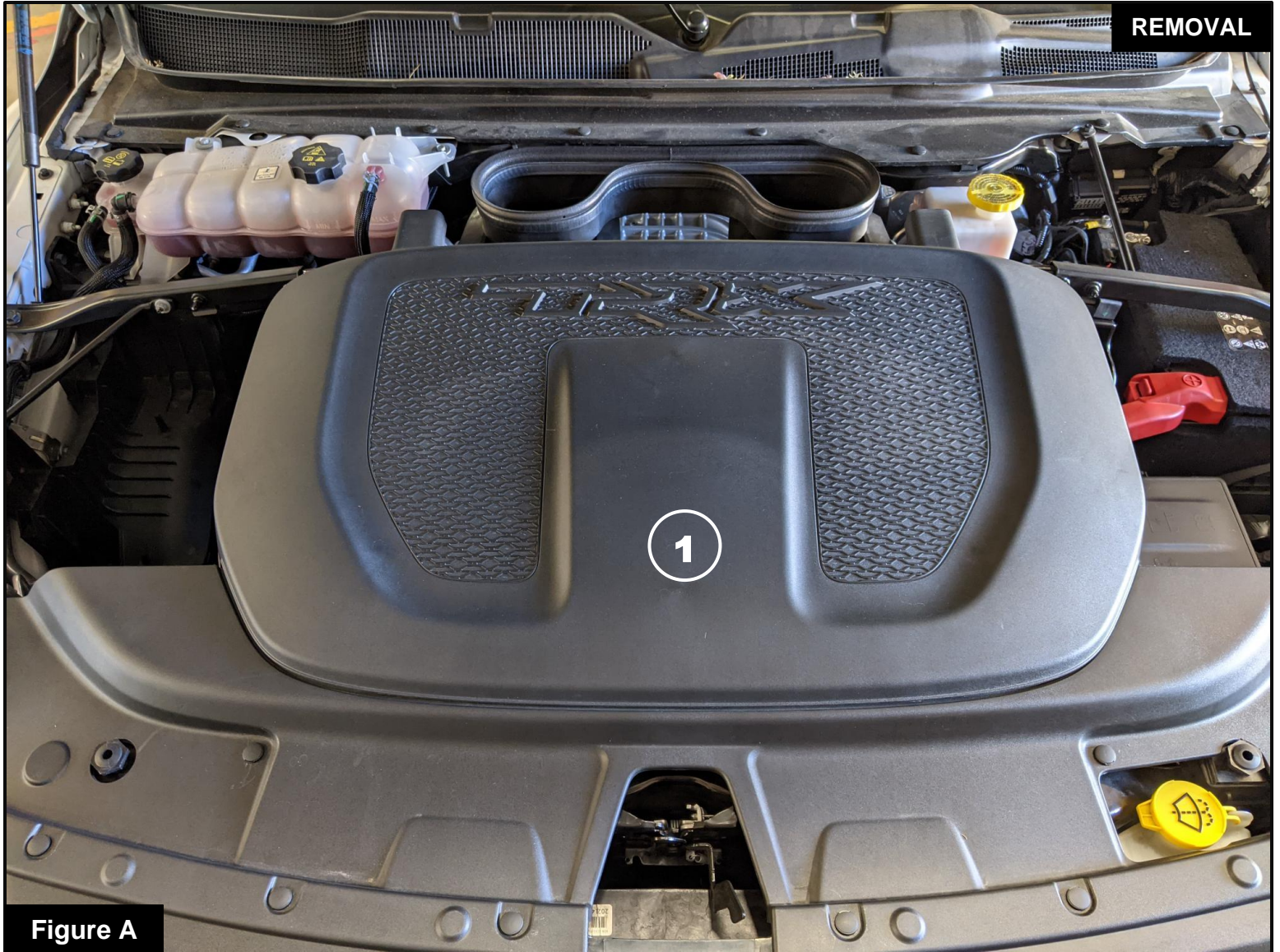

Refer to Figure A for Step 1

Step 1: Remove the factory air intake cover (1).

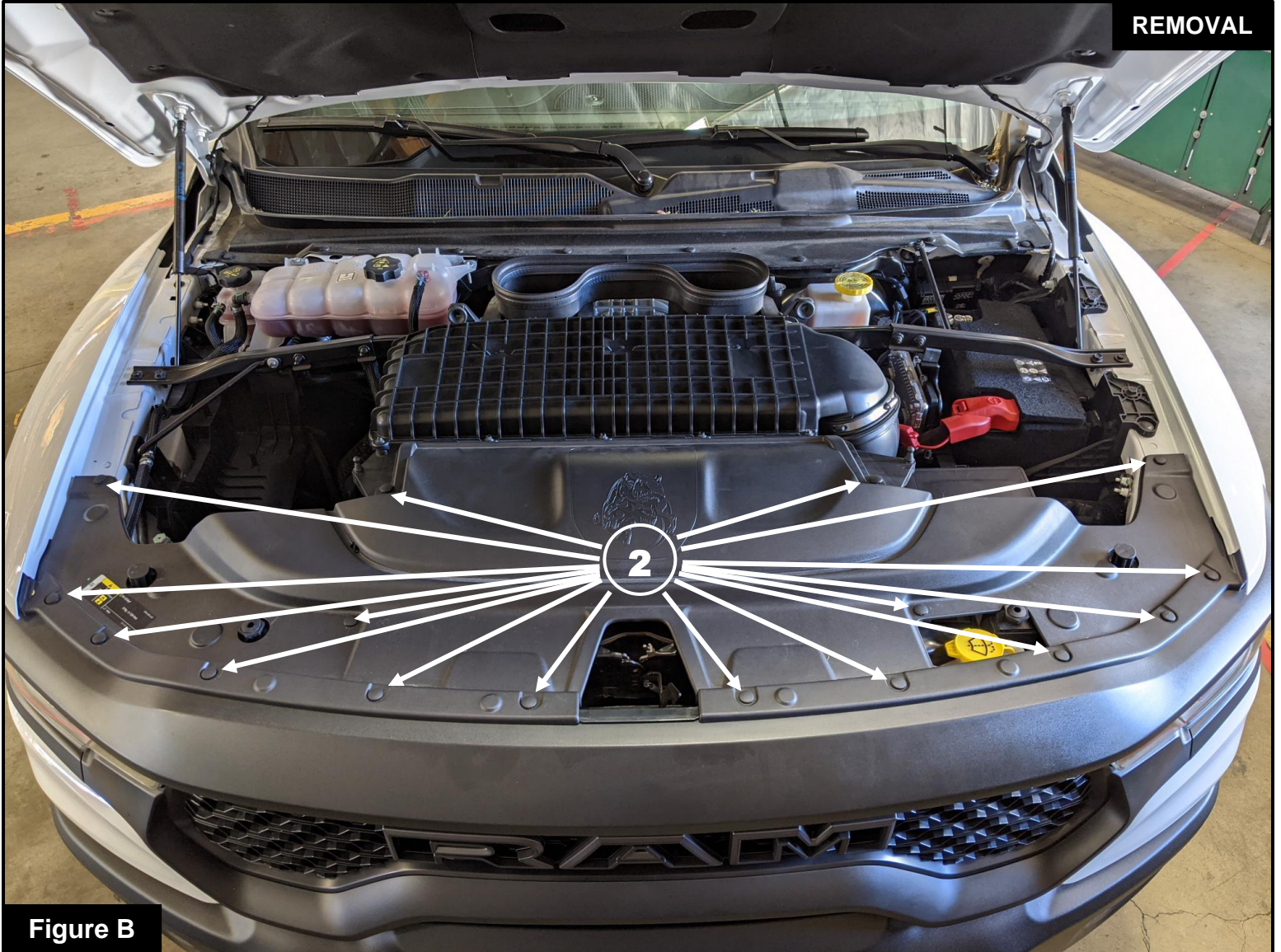
**Figure B****Refer to Figure B for Step 2**

Step 2: Using a small trim removal tool, remove the sixteen (16) clips ② securing the factory front cowl, then remove the cowl.

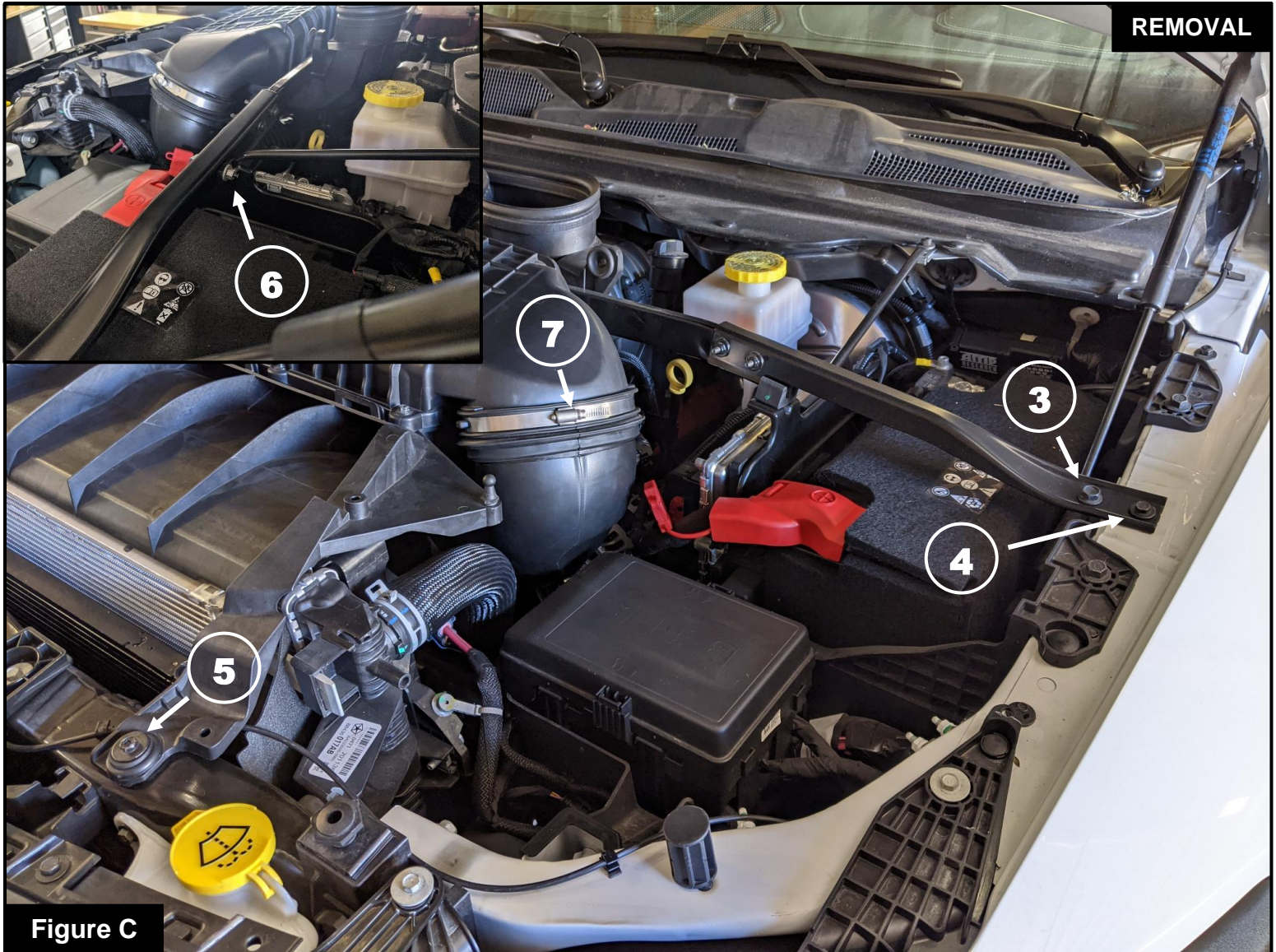

Figure C

Refer to Figure C for Steps 3-5

Step 3: On the driver side of the vehicle, use a 13mm socket and driver to remove the larger screw (3) securing the factory intake brace.

Step 4: Using a 10mm socket and driver, remove the smaller screw securing the factory intake brace (4) as well as the screw (5) securing the factory intake to the core support in the front of the vehicle. Remove the single nut (6) on the back side of the intake brace using a 10mm socket and driver.

Step 5: Using an 8mm socket and driver, loosen the clamp (7) at the factory air intake tube.

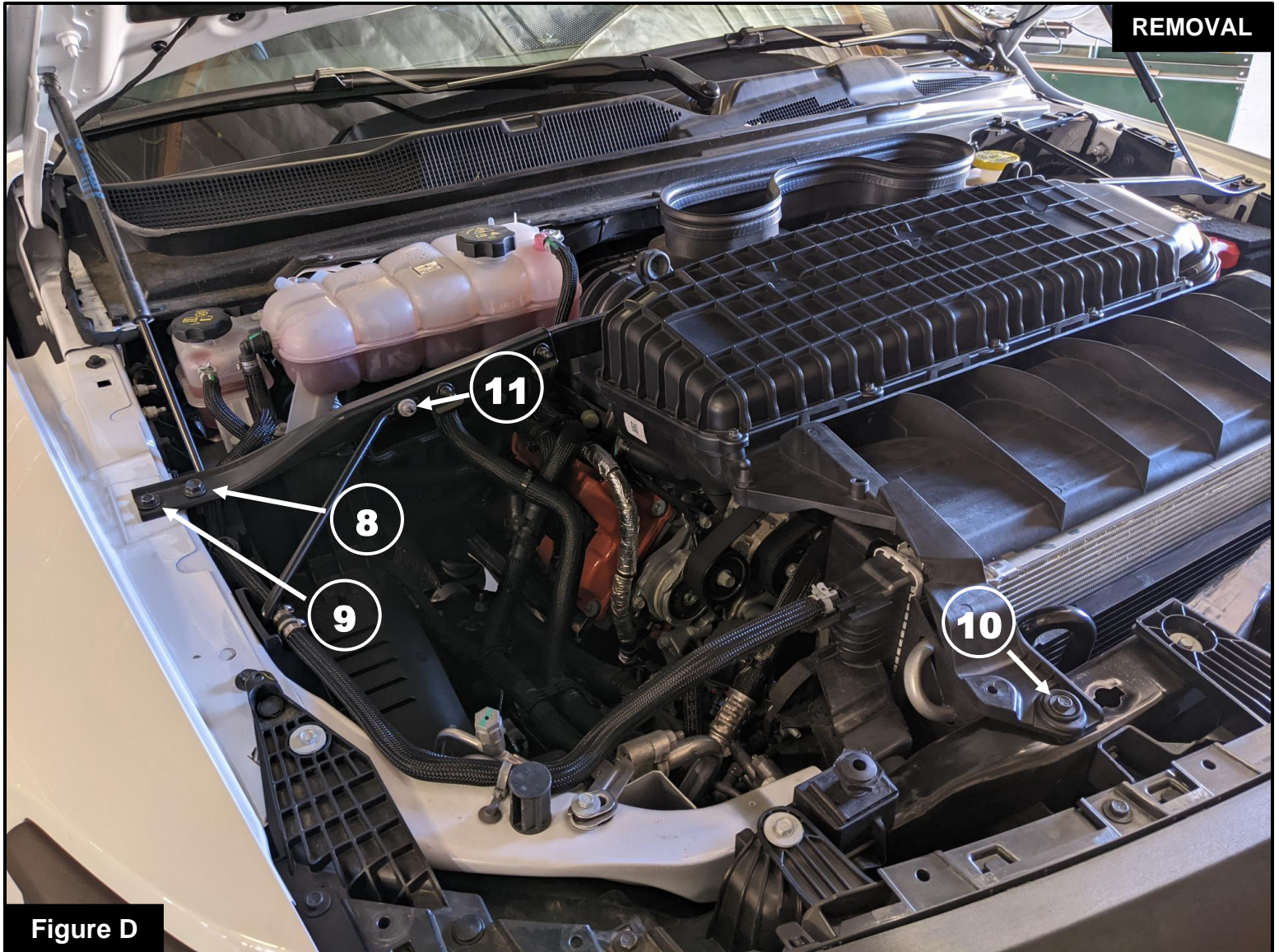

Figure D

Refer to Figure D for Steps 6-8

Step 6: On the passenger side of the vehicle, use a 13mm socket and driver to remove the larger screw (8) securing the factory intake brace.

Step 7: Using a 10mm socket and driver, remove the smaller screw securing the factory intake brace (9) as well as the screw (10) securing the factory intake to the core support in the front of the vehicle. Remove the single nut (11) on the front side of the intake brace using a 10mm socket and driver.

Step 8: Carefully lift the factory air intake out of the vehicle leaving the intake tube in the vehicle.

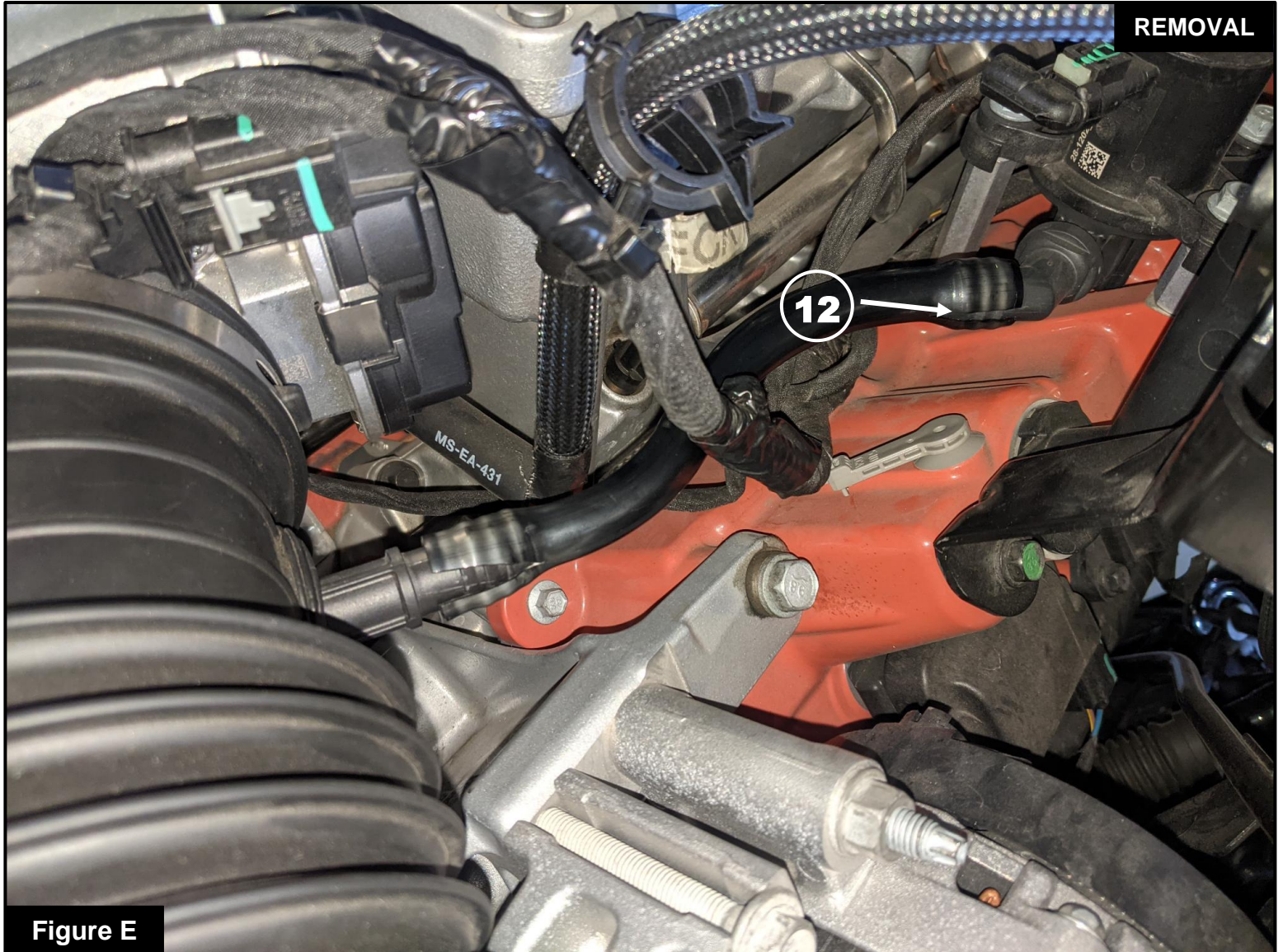
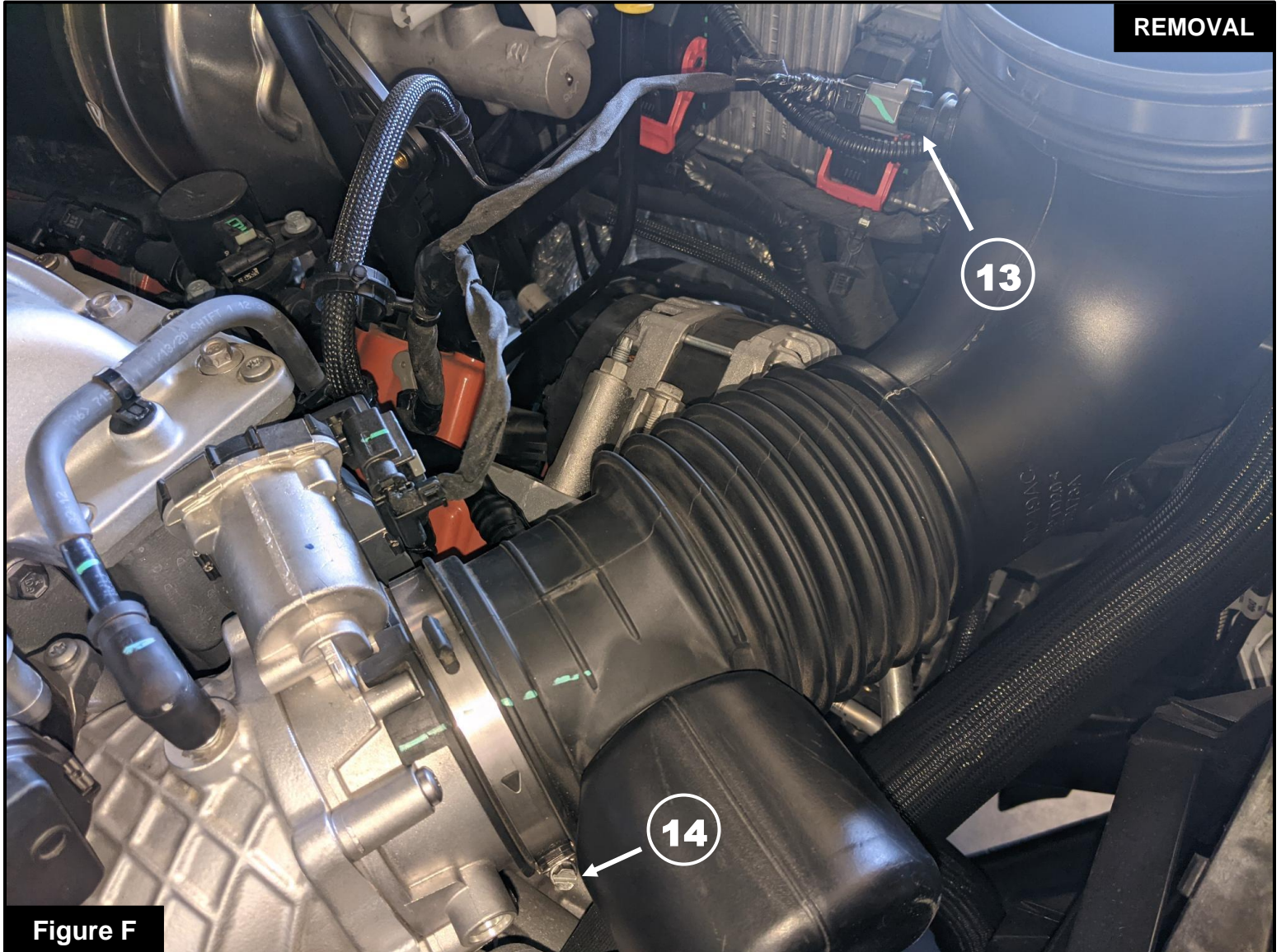

Figure E

Refer to Figure E for Step 9

Step 9: Using a razor blade, carefully cut the plastic line (12) connected to the MUA system on the valve cover. If you ever need to reinstall the factory intake, we recommend using heat-shrink to cover the cut.



Refer to Figure F for Steps 10-11

Step 10: Disconnect the temperature sensor wire harness (13).

Step 11: Using an 8mm socket and driver, loosen the clamp at the throttle body (14) then remove the factory air intake tube.

**Figure G****Refer to Figure G for Steps 12-13**

Step 12: Transfer the temperature sensor (15) from the factory air intake tube into your aFe Carbon Fiber intake tube.

Step 13: Install the supplied wrapped silicone coupler with the 2 largest supplied T-Bolt clamps onto the oval end of your aFe Carbon Fiber intake tube. Leave both clamps loose.

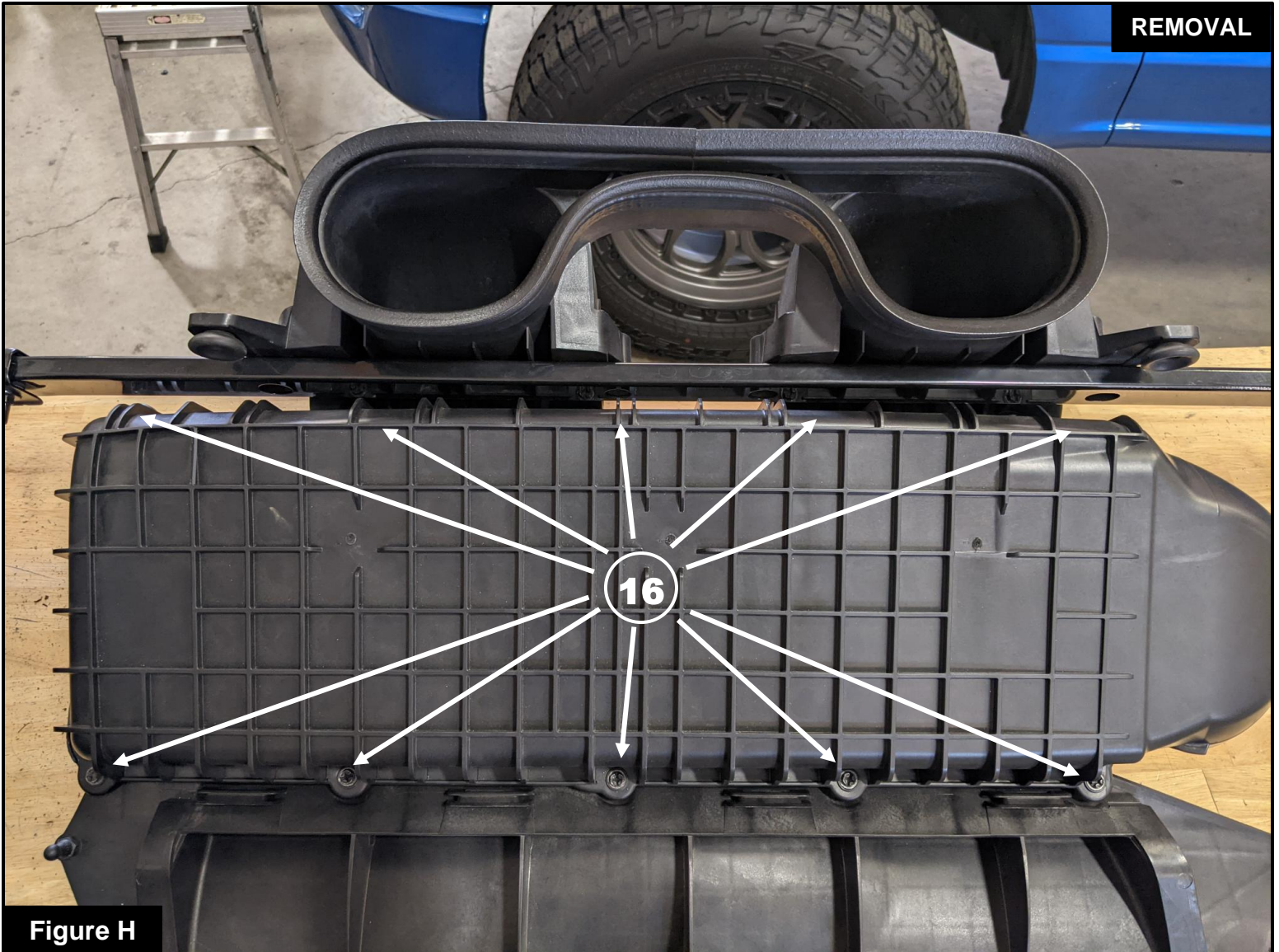
**Figure H****Refer to Figure H for Step 14**

Step 14: Using an 8mm socket and driver with an extension, loosen the ten (10) screws **16** sealing the factory filter housing and remove the lid.

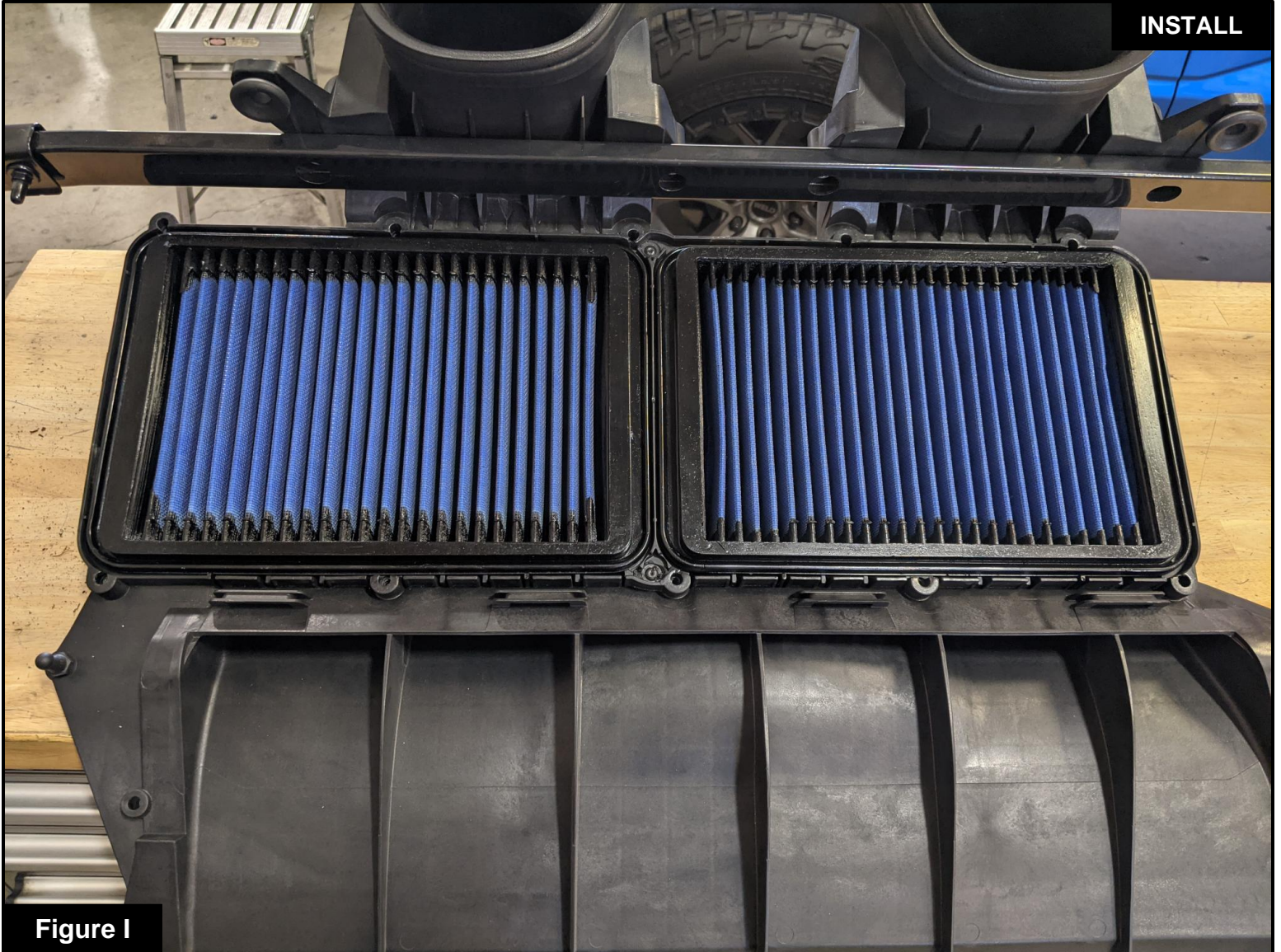
**Figure I****Refer to Figure I for Step 15**

Step 15: Remove the factory air filters and replace with your aFe POWER flat panel air filters, then replace the factory filter housing lid and tighten the ten (10) screws using an 8mm socket and driver with an extension.

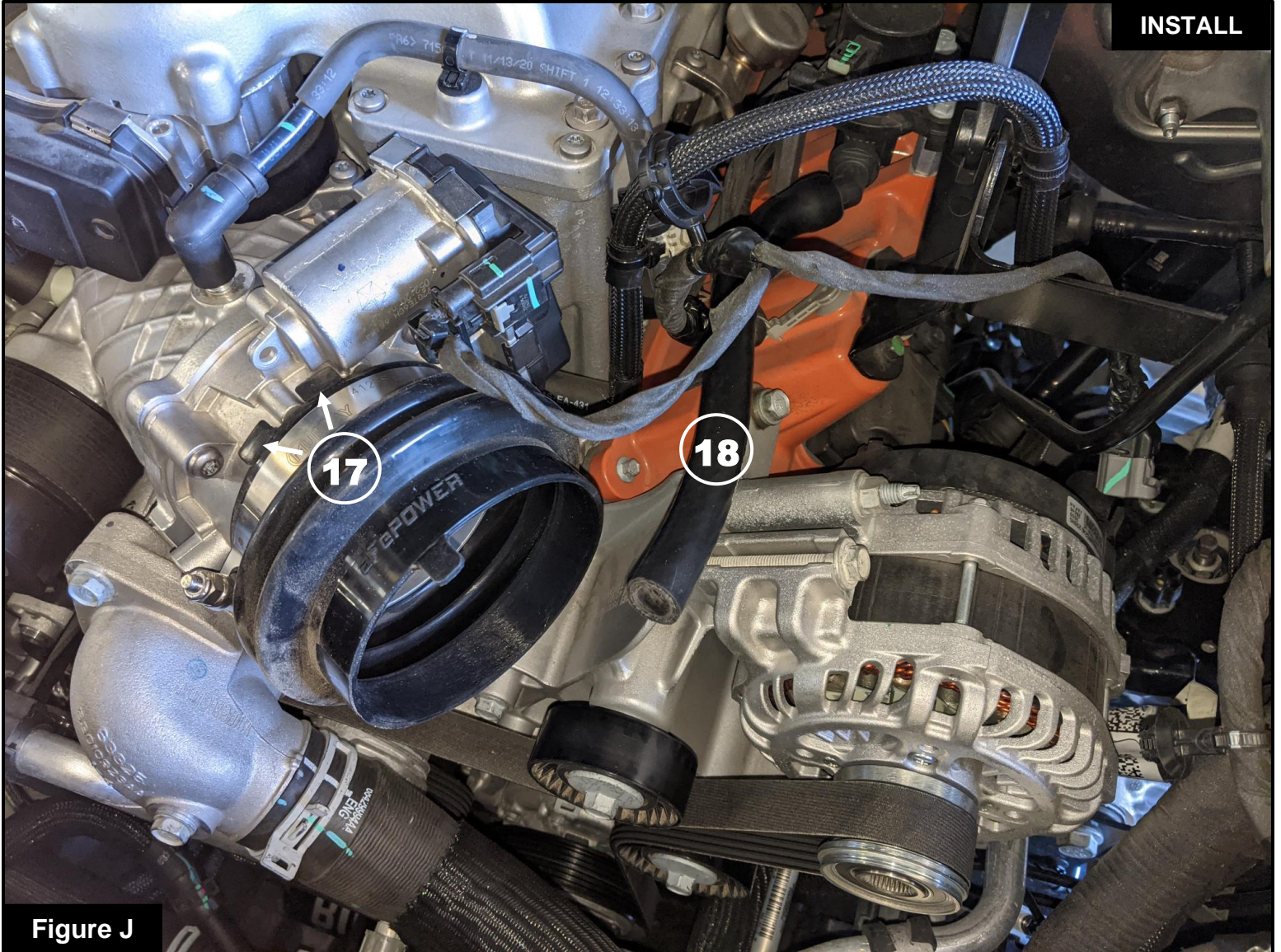
**Figure J****Refer to Figure J for Steps 16-17**

Step 16: Install the supplied bellow coupling with the smaller side on the throttle body making sure the indexing tabs (17) are straddling the index on the throttle body as shown. Once aligned, secure the coupling with the smallest supplied T-Bold clamp and tighten using an 11mm deep socket and driver.

Step 17: Install the supplied length of hose (18) onto the MUA system as shown.

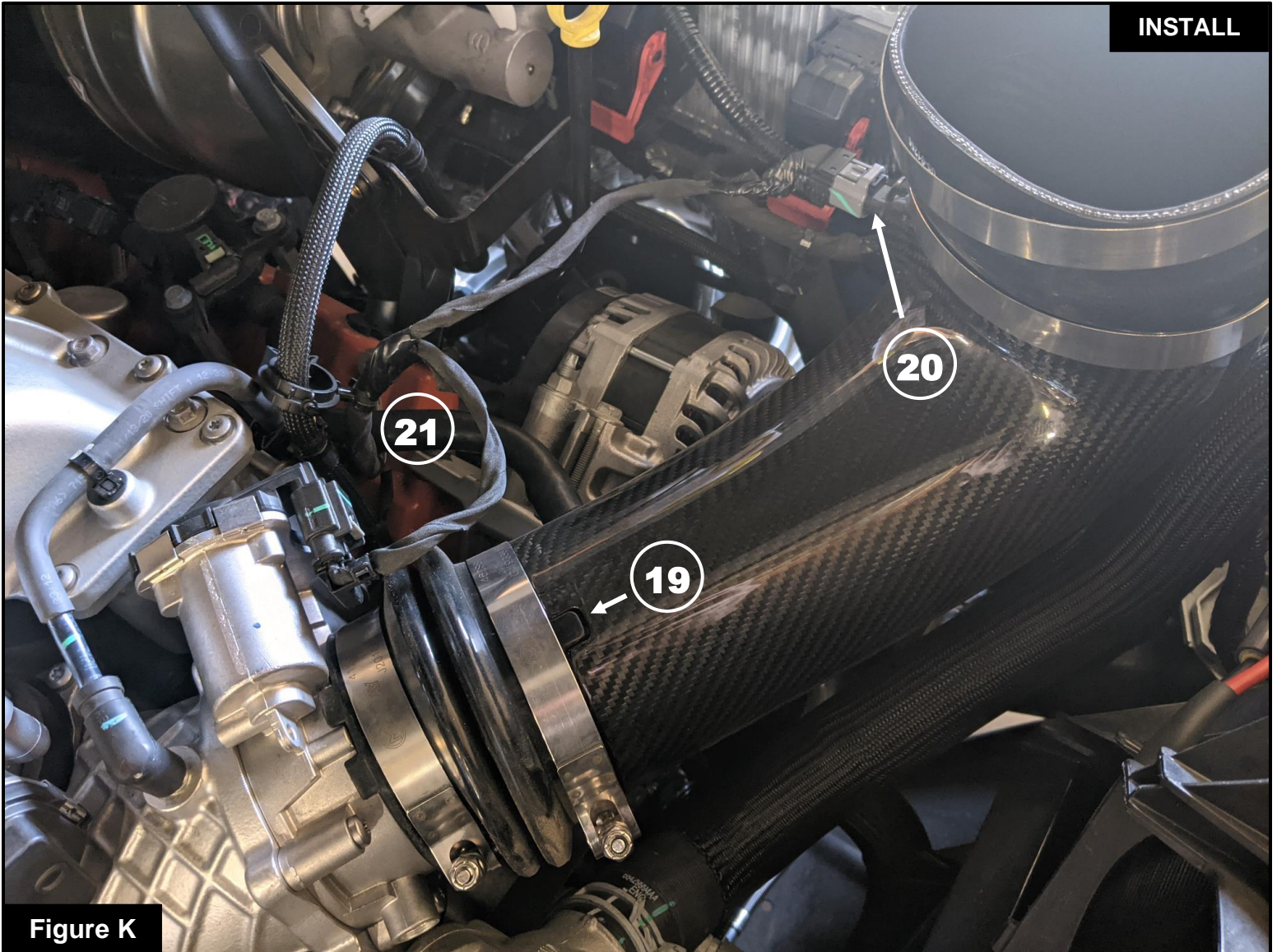
**Figure K****Refer to Figure H for Steps 18-20**

Step 18: Install your aFe POWER Carbon Fiber intake tube into the bellow coupling at the throttle body making sure the align the index tab on the coupling (19) with the index on the tube as shown. Secure the tube using the last remaining T-Bolt clamp and tighten using an 11mm deep socket and driver. ***Do not overtighten this clamp or you will crack the carbon fiber***

Step 19: Reconnect the temperature sensor wire harness (20) .

Step 20: Connect the hose (21) to the metal port on your intake tube.

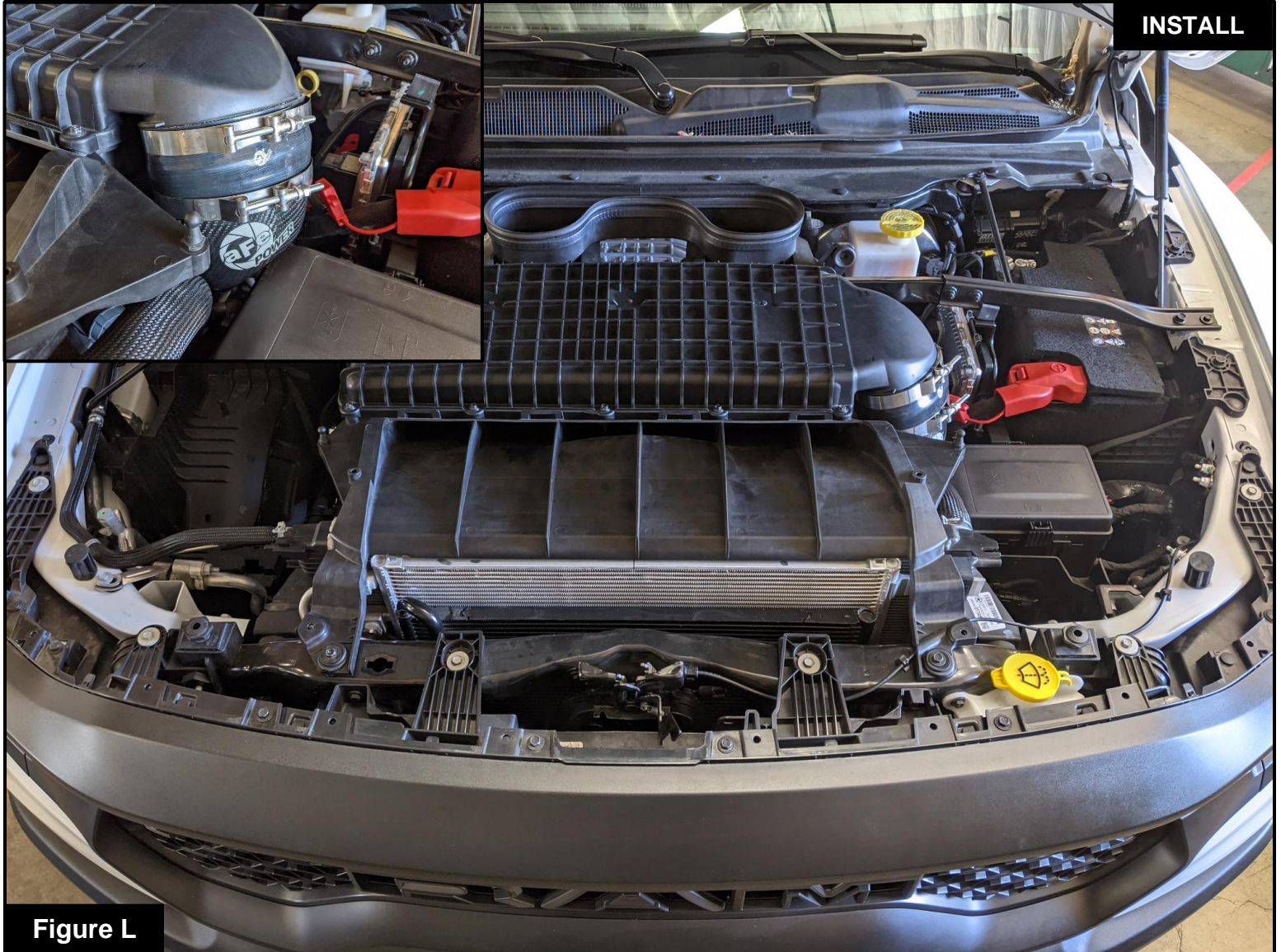

Figure L

Refer to Figure L for Steps 21-22

Step 21: Re-install the factory filter housing assembly by following steps 3-7 in reverse order. While installing the system, make sure the filter housing outlet slips into the wrapped silicone coupling on your carbon fiber intake tube. Use a trim removal tool to assist if necessary.

Step 22: Once fully seated against the tabs on the filter housing outlet, use an 11mm deep socket and ratchet to tighten both clamps.



Refer to Figure M for Steps 23-24

Step 23: Re-install the front cowl using the sixteen (16) clips removed in step 2.

Step 24: Re-install the factory air intake cover. Your Installation is now complete. Thank you for choosing aFe POWER!

NOTE: Check all screws, clamps, and connectors are secure after 100-200 miles



PAGE LEFT BLANK INTENTIONALLY



PAGE LEFT BLANK INTENTIONALLY



PAGE LEFT BLANK INTENTIONALLY

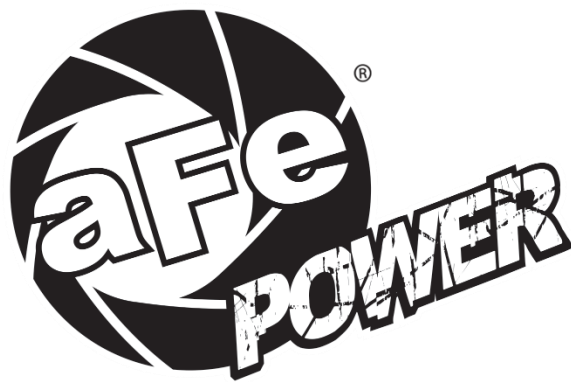

advanced FLOW engineering, inc.

252 Granite Street Corona, CA 92879
TEL: 951.493.7100 • TECH: 951.493.7185
E-Mail: Tech@aFepower.com